

Department of the Secretary of State

<http://www.maine.gov/sos>



Charles E. Summers, Jr.
Secretary of State

Ensuring Accessibility

Goals and Solutions for
Improving the Accessibility
of Maine's Polling Places

2006

Dear Municipal Clerk:

The Secretary of State's office is pleased to provide this guide to "Ensuring Accessibility: Goals and Solutions for Improving the Accessibility of Maine's Polling Places". Originally distributed in 2004, this guide reflects our commitment to ensuring equal access to Maine's elections for all citizens. Working with you and other municipal leaders, we intend to make additional progress toward this extensive, and important, goal.

The information found in this guide is meant to help municipal officials improve the accessibility of voting facilities. This booklet has been provided as a summary of the regulations contained in the federal Americans with Disabilities Act (ADA) and state accessibility laws.

Please use this publication as a reference guide for reviewing current voting locations and for future selection of additional or replacement facilities. Enclosed are specific measurements and guidelines for parking spaces, doorways, routes of travel, and other important aspects of the voting location. Following each section of requirements are tips and solutions for areas needing improvements.

The selected standards are adapted from the ADA Checklist for Polling Places, published by the US Department of Justice. As this booklet is not meant to be comprehensive, we encourage you to visit the ADA websites for the complete and detailed requirements specific to your voting location(s).

As always, our staff is willing to assist you with any questions you may have. You may contact us at (207) 624-7650. We appreciate your cooperation in this ongoing effort and value the work you do each day to strengthen the electoral process.

Sincerely,

Elections Division
Bureau of Corporations, Elections and Commissions
Office of the Secretary of State

TABLE OF CONTENTS

Parking Area Requirements	4
Sidewalk/Walkway Requirements.....	8
Passenger Drop-Off Area Requirements	11
Building Entrance and Interior Door Requirements	13
Hallway and Corridor Requirements	17
Ramp Requirements	19
Elevator Requirements.....	22
Platform or Wheelchair Lift Requirements	24
Voting Area Requirements.....	25
Polling Place Accessibility Survey	26

**All ADA standards have been referenced from:
Department of Justice Code of Federal Regulations, 28 CFR
Part 36, ADA Standards for Accessible Design**

Web addresses:

www.access-board.gov/adaag/html/adaag.htm

www.usdoj.gov/crt/ada/stdspdf.htm

PARKING AREA REQUIREMENTS

There is no requirement for polling places to have voter parking. However, if parking is provided for voters (whether on-street or off-street), accessible parking must also be provided.

Total Parking Spaces in Lot	Required Minimum Number of Accessible Spaces ADA Stds. 4.1.2(5)(a)
1 to 25	1 van-accessible spot
26 to 50	1 van-spot + 1 regular accessible spot
51 to 75	1 van-spot + 2 regular accessible spots
76 to 100	1 van-spot + 3 regular accessible spots
101 to 150	1 van-spot + 4 regular accessible spots
151 to 200	1 van-spot + 5 regular accessible spots
201 to 300	1 van-spot + 6 regular accessible spots
301 to 400	1 van-spot + 7 regular accessible spots
401 to 500	2 van-spots + 7 regular accessible spots
501 to 1000	2 percent of total *
1001 and over	20, plus 1 for every 100 over 1000 *

*1 in every 8 accessible spaces must be a van-accessible spot.

- Van-accessible spaces must be 96" wide and accompanied by a 96" wide access aisle on either side. Non-van-accessible parking spaces shall be at least 96" wide and accompanied by a 60" minimum access aisle on either side. ADA Stds. 4.1.2(5)(a) & (b), 4.6.3
- Accessible parking spaces may share an access aisle, so long as the 96" aisle requirements are fulfilled for the van-spot. ADA Stds. 4.6.3 (see figure below)

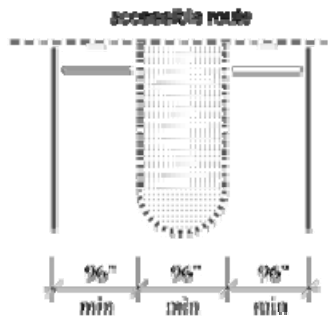

- Accessible spaces shall be clearly marked with proper signage using the international symbol of accessibility. Signage must be visible even while the space is occupied. ADA Stds. 4.6.4, 4.30.7(1) (see figure below for international symbol of accessibility)



- Van-accessible spaces shall have proper 8'2" vertical clearance. ADA Stds. 4.1.2(5)(b), 4.6.5
- Surface of parking area shall be stable, firm, slip resistant, and free from abrupt level changes over 1/4". ADA Stds. 4.5.1, 4.5.2
- Parking area shall be relatively level (1:50 or 2% maximum slope in any direction). ADA Stds. 4.6.3
- Accessible spaces shall be on the shortest route to the accessible building entrance. ADA Stds. 4.6.2
- Curb ramps connecting parking to the accessible route shall be at least 36" wide, excluding flared sides. Slope of curb ramp shall be no greater than 1:12 (that is 1 inch of vertical rise for every 12 inches of ramp length). ADA Stds. 4.7.3, 4.7.2, 4.8.2 (see figure below)



Tips and Solutions for Parking Areas

People who have difficulty walking or maintaining balance or who use crutches, canes, or walkers, and those with restricted gaits are particularly sensitive to slipping and tripping hazards. For such people, a stable and regular surface is necessary for safe walking. Wheelchairs can be navigated most easily on hard surfaces that are stable and regular. A cross-slope (which is the incline from side to side across the path of travel) on walks or ground surfaces can cause considerable difficulty in propelling a wheelchair in a straight line. Soft loose surfaces such as loose sand or gravel, or wet clay, and irregular surfaces such as cobblestones can significantly impede wheelchair movement. To eliminate these hazards, provide an asphalt or concrete parking area, access aisle, and walkway to your building. You may also purchase surface-smoothing mats which can be placed on grass or gravel to allow easy passage for wheelchairs.

A sign is needed to alert van users to the presence of the wider aisle, but the space is not intended to be restricted only to vans.

When an access aisle has a sloped surface, a wheelchair may roll away from a car or van preventing the wheelchair user from getting out of the vehicle. The sloped surface also prevents a van-mounted wheelchair lift from being fully lowered to the access aisle surface.

If your accessible parking is on a sloped surface, find a parking area that is more level and provide parking spaces and access aisles in that area. Make sure that these spaces connect to an accessible walkway to the accessible polling place entrance.

Typically, three standard parking spaces can be converted into an accessible parking space with an access aisle. Cones, or even masking tape, may be used to mark the access aisle but must connect to an accessible walkway to the polling place. (see figure next page)

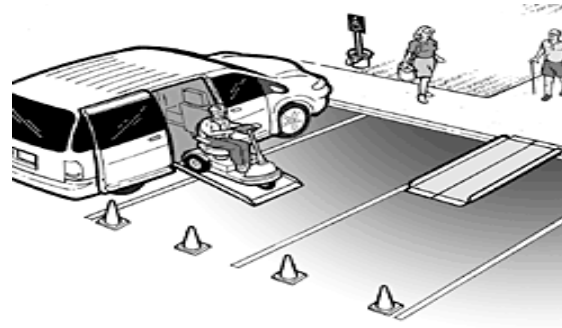

Portable signage can be placed in front of temporary accessible parking spaces.

Portable curb ramps can be used where walkways cross a curb and a permanent curb cut is not present. These portable ramps can then be used at different locations in the future if needed.

Filler can be purchased to repair damaged areas where surfaces are not stable and create abrupt level changes (e.g., cracks in asphalt) that can be hazardous.

SIDEWALK/WALKWAY REQUIREMENTS

Sidewalks/Walkways include the outside path of travel from parking, passenger drop off areas, and public transit stops on the property all the way to the accessible entrance. There is no requirement for a polling place to have a passenger drop-off area or public transportation stop.

- An accessible route from the parking area to the building entrance shall be provided. ADA Stds. 4.1.2(1), 4.3.2
- Post signage to indicate the accessible route to the building entrance. ADA Std. 4.1.2(7)
- Minimum width for an accessible route is 36". ADA Std. 4.3.3
- Walkways must be free of abrupt level changes over ¼", or may be up to ½" if beveled. ADA Stds. 4.3.8, 4.5.2
- A curb ramp shall be provided where a walkway crosses a curb. The slope of a curb ramp shall not exceed 1:12 (that is, one inch of vertical rise for every 12 inches of ramp length). ADA Stds. 4.3.8, 4.7.2, 4.8.2 (see figure on page 5)
- Any portion of a walkway with a slope greater than 1:20 shall be considered a ramp. ADA Std. 4.8.1
- Objects located along a walkway must be cane detectable (with a bottom edge no higher than 27" and not protruding from wall more than 4"). ADA Std. 4.4.1
- Objects that hang over a walkway must be placed with their bottom edges higher than 80". ADA Std. 4.4.2
- The undersides of exterior stairs must be enclosed or protected with a cane detectable barrier. ADA Std. 4.4.2 (see figure below)

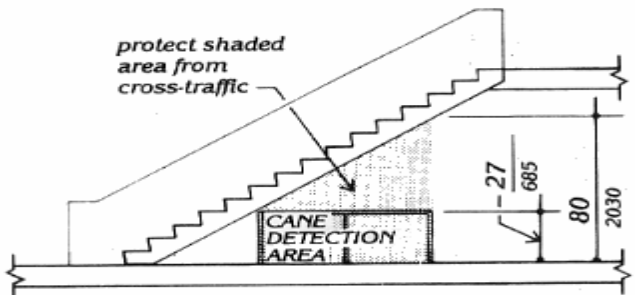

- An accessible route must also be provided from public sidewalks and public transportation stops (where public sidewalks and transit stops are evident) to the accessible entrance of the polling place. ADA Std. 4.1.2(1), 4.3.2(1), 4.14.1

Tips and Solutions for Sidewalks/Walkways

Where an accessible route is different from the route used by most voters, signs will be needed at key decision points to direct voters with disabilities to the accessible building entrance. For example:



Many people with mobility impairments can move only at very slow speeds, even on level ground. On trips over 100 feet, people with disabilities are apt to rest frequently, which substantially increases their trip times. Resting periods of 2 minutes for every 100 feet can be used to estimate travel times for people with severely limited stamina. In inclement weather, slow progress and resting can greatly increase a disabled person's exposure to the elements.

If the direct route is not accessible, check to see if there is another less direct route that can serve as the accessible route. Routes that are indirect but level or those with running slopes less than 1:20 can sometimes provide more convenience than direct routes with maximum allowable slopes.

The accessible route shall, to the fullest extent possible, coincide with the route for the general public. If the accessible route crosses a vehicular way, a marked crosswalk should be used.

An accessible route may narrow briefly to 32" wide where utility poles, post-mounted signs, furniture, and doorways are located along the route.

If the route to the accessible entrance crosses a curb or stairs, a portable ramp, with a slope no steeper than 1:12 and edge protection when required, should be used.

Filler can be purchased to repair damaged areas where surfaces are not stable and create abrupt level changes (e.g., cracks in asphalt) that can be hazardous.

Objects along the walkway that protrude too far from the side or hang too low from above the path of travel may be a hazard for people who are blind or have impaired vision when they cannot detect an object by using the sweep of their cane. Placing a cane detectable object or barrier below the protruding or low hanging object (see figures below) should allow identification of these hazards. Check low-hanging tree branches to ensure they are at least 80" above the ground and prune when necessary.

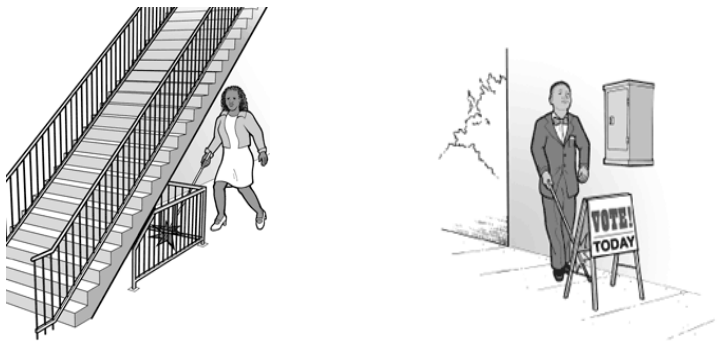

PASSENGER DROP-OFF AREA REQUIREMENTS

There is no requirement for a polling place to have a passenger drop-off area. However, if one is present on Election Day, it must be accessible.

- The vehicle space and access aisle must be relatively level (1:50 or 2% maximum slope in any direction). ADA Std. 4.6.6
- The access aisle must be at least 60” wide and 20 feet long. ADA Std. 4.6.6
- The vehicle route, loading zone, drop-off area, and exit must provide 9’6” vertical clearance. ADA Std. 4.6.5
- Post signage to indicate the accessible passenger drop-off area using the international symbol of accessibility. ADA Std. 4.1.2(7)(b)
- Curb ramps connecting the drop-off area to the accessible route shall be at least 36” wide, excluding flared sides. The slope of a curb ramp shall be not greater than 1:12. ADA Std. 4.7.3, 4.7.2, 4.8.2 (see figure on page 5)
- An accessible route must be provided from passenger drop-off areas to the accessible entrance of the polling place. ADA Std. 4.1.2(1), 4.3.2(1), 4.14.1 (see figure below)

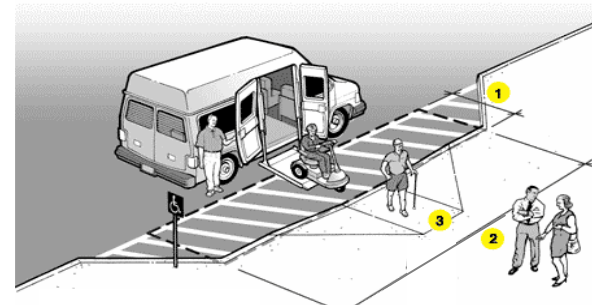

(1) Access aisle depth is at least 5 feet; (2) Access aisle length is at least 20 feet; (3) Curb ramp connects access aisle to the accessible route and entrance of the polling place

Tips and Solutions for Passenger Drop-Off Areas

If your polling place is served by passenger drop-off areas, at least one drop-off area must be accessible. An accessible drop-off area (also known as an accessible passenger loading zone) must have a level access aisle which is adjacent and parallel to the vehicle space. The access aisle may be at the street or sidewalk level. If it is at the sidewalk level, a curb ramp should be provided between the street and the sidewalk.

High-top vans, often used by people with disabilities or by transportation services, require higher clearances than automobiles.

Two or more level parking spaces may be used to create a passenger drop-off area. Cones or another temporary barrier may be used to keep the area clear for use as the access aisle.

BUILDING ENTRANCE AND INTERIOR DOOR REQUIREMENTS

Each polling place must have at least one accessible entrance connected to an accessible route on Election Day. The accessible entrance does not require signage if it is the only entrance to the building. There is no weight restriction on exterior doors.

- An accessible polling place must have at least one accessible entrance. ADA Stds. 4.1.3(1), 4.3.2(3), 4.3.9, 4.13
- Post signage to indicate the accessible entrance using the international symbol of accessibility. ADA Stds. 4.1.2(7)(c), 4.30.7
- All doors along the accessible route must provide at least 32” clear passage width when the door is open at 90 degrees. ADA Std. 4.13.5
- Door handles on any accessible doors shall have a shape that is easy to grasp with one hand and does not require tight grasping, pinching, or twisting of the wrist to operate. ADA Std. 4.13.9
- Door handles shall be mounted no higher than 48” above finished floor. ADA Std. 4.13.9
- If the door is not automatic or power-operated, there must be at least 18” clearance provided on the pull side of the door for wheelchair users to be able to reach the door handle while stationed to the side of the door. ADA Std. 4.13.6 (see figures below)

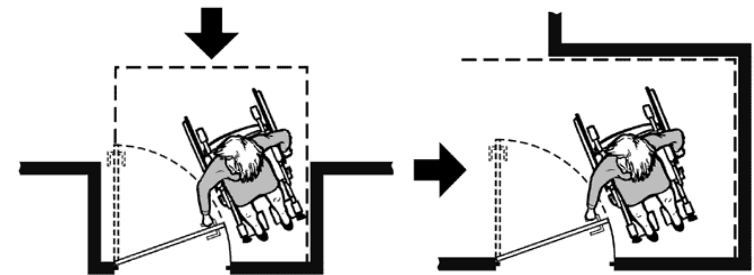

- The change in level from the ground or floor to the threshold at any accessible door must be less than 1/2”, or may be up to

- 5 lbs. is the maximum force allowed for pushing or pulling open an interior door. ADA Std. 4.13.11
- If the entryway at the accessible entrance includes a vestibule (area between 2 doors), then the clear floor space must be at least 30" x 48" beyond the swing of both doors. ADA Std. 4.13.7 (see figure below)

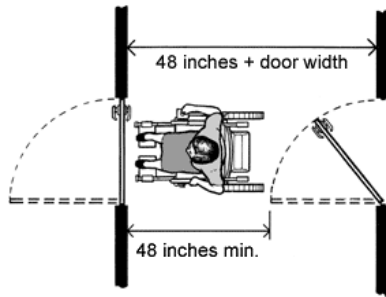

Tips and Solutions for Building Entrances and Interior Doors

If the accessible building entrance is not the primary entrance used on Election Day, or if there are other inaccessible entrances serving the polling place, signage placed at inaccessible entrances and at key decision points can aid in finding the accessible building entrance. For example:



A person using a wheelchair cannot open the door without a clear and level area in front of and adjacent to the door that provides a place to maneuver. (see figures below)

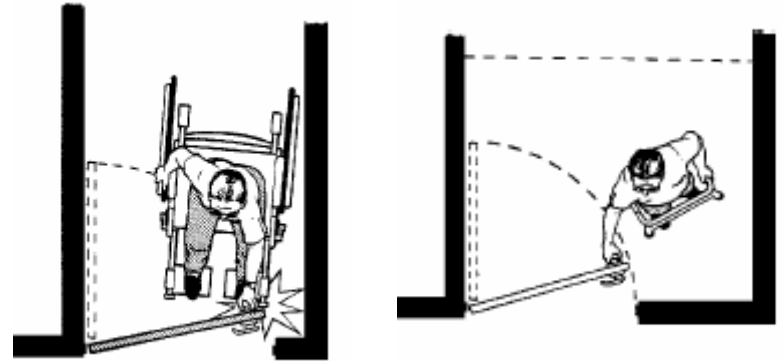

Thresholds and surface height changes in doorways are particularly inconvenient for wheelchair users because complex maneuvering is required to get over the level change while operating the door.

Threshold ramps, a helpful and affordable solution for removing threshold barriers, are designed to assist wheelchair or scooter users over small thresholds, such as those found in doorways. They can be purchased in various lengths and widths to fit your needs.

Door hinges that allow the door to swing completely clear of the opening can be installed. These swing clear hinges, which will increase the clear passage width of doorways, may be helpful in cases where the clear passage of the door when open at 90 degrees is 1 or 2 inches short of the 32" requirement.

Accessible door handles are operable with a closed fist. When door handles are inaccessible, the force of the door is not easy to push/pull open, or your polling location does not offer 18" clearance on the pull side of the door, keep the door propped open or station volunteers near the door to open it for voters. Automatic door openers will also eliminate these barriers.

If you do not have the minimum required clear floor space in the vestibule, keep one of the doors propped open on voting day to create an accessible entrance.

If there is a small step present at the entrance then a ramp with a slope no greater than 1:12 (and edge protection when required) should be used to provide access.

HALLWAY AND CORRIDOR REQUIREMENTS

Hallways and corridors include the inside path of travel from the accessible entrance all the way to the voting area. The route does not have to be marked with the symbol of accessibility unless it is different from the route most voters use.

- An accessible route from the accessible entrance to the voting area must be provided. ADA Stds. 4.1.3(1), 4.3.2(1)
- Minimum width for an accessible route is 36". ADA Std. 4.3.3
- The accessible route must be free of abrupt level changes over 1/4"; changes in level between 1/4" and 1/2" must be beveled. ADA Stds. 4.3.8, 4.5.2
- If an accessible route has changes in level greater than 1/2", or if the voting area is located on a different floor than the accessible building entrance, then a ramp, elevator, or lift shall be provided. ADA Stds. 4.3.8, 4.5.2
- Objects located along hallways/corridors must be cane detectable (bottom edge may not be between 27" and 80" from the floor and protrude from the wall more than 4"). ADA Std. 4.4.1 (see figure below)
- Objects that hang over a walkway must be placed with their bottom edges higher than 80". ADA Std. 4.4.2 (see figure below)

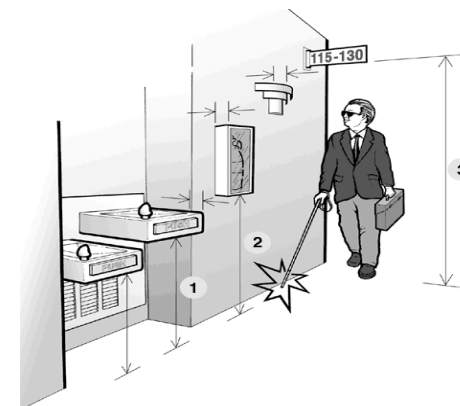

(1) & (2) If higher than 27", may not protrude more than 4"; (3) Bottom edge must be higher than 80"

- Interior doors along the accessible route to the voting area must be accessible as described in the Building Entrance and Interior Door Requirements section. ADA Std. 4.13
- The undersides of interior stairs must be enclosed or protected with a cane detectable barrier. ADA Std. 4.4.2 (see figures on pages 8 and 10)

Tips and Solutions for Hallways and Corridors

People who have difficulty walking or maintaining balance or who use crutches, canes, or walkers, and those with restricted gaits are particularly sensitive to slipping and tripping hazards. For these people, a stable and regular surface is necessary for safe walking. Wheelchairs can be propelled most easily on surfaces that are hard, stable, and regular. Soft, loose surfaces such as shag carpet and irregular surfaces such as uneven hardwood flooring can significantly impede wheelchair movement.

Potentially hazardous objects are noticed only if they fall within the detection range of canes. Items that are not cane detectable protrude more than 4” out from the wall and have a bottom edge higher than 27” from the ground. These items may include wall-mounted display cases, fire extinguishers, wall sconces, and light fixtures. Open staircases, overhead signs, banners, and arched doorways that are lower than 80” above the floor are also hazardous. Cones can be placed under potentially hazardous objects that are not cane detectable. This will alert a person to go around the hazardous object.

If the voting area is not along an accessible route and cannot be made accessible, look for an accessible area to use as the voting area.

There is a large selection of pre-built ramps available to fit almost any situation. Ramps may be used as either permanent or temporary solutions.

RAMP REQUIREMENTS

Any section of an accessible route (exterior or interior) with a slope greater than 1:20 is considered a ramp.

- Any part of an accessible route, either along an outside sidewalk or an interior hallway, with a slope greater than 1:20 must meet the requirements for an access ramp. ADA Std. 4.8.1
- An accessible route does not include stairs, steps, or escalators. If an accessible route has changes in level greater than 1/2", then a curb ramp, ramp, elevator, or platform lift shall be provided. ADA Std. 4.3.8
- The least possible slope shall be used for any ramp. The maximum slope of a ramp shall be 1:12. A slope of 1:12 is one inch of vertical rise for every 12 inches of ramp length. ADA Std. 4.8.2
- If a ramp run has a rise greater than 6" or is longer than 6 feet, then handrails must be provided on both sides of the ramp. ADA Std. 4.8.5 (see figure below)
- The diameter or width of the gripping surfaces of a handrail or grab bar shall be 1 1/4" to 1 1/2". ADA Std. 4.26.2
- Handrails shall not rotate within their fittings. ADA Std 4.8.5(7)
- The handrails must be mounted between 34 and 38 inches above the ramp surface. ADA Std. 4.8.5(5) (see figure following)
- The ramp surface must be at least 36" wide. This is measured between handrails when handrails are present. ADA Std. 4.8.3
- The maximum rise for any ramp section is 30 inches, or 30 feet maximum length. ADA Std. 4.8.2
- Level landings must be provided at the bottom and top of each ramp and at each ramp section of 30 feet. ADA Std. 4.8.4 (see figure following)
- The landing shall be at least as wide as the ramp run leading to it. The landing length shall be a minimum of 60" (clear of any doors or other obstructions). ADA Stds. 4.8.4(1) & (2)
- If a ramp changes direction at the landing, the minimum landing size shall be 60" by 60". ADA Std. 4.8.4(3)

- Ramps and landings with vertical drop-offs shall have edge protection of at least 2” high in the form of curbs, walls, or railings. ADA Std. 4.8.7

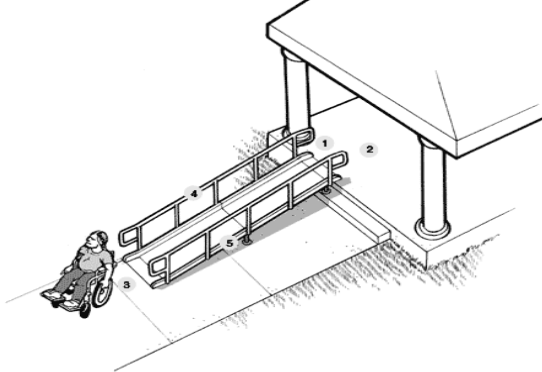

(1) At least 36” between handrails; (2) Top landing part of walk; (3) Bottom landing part of walk; (4) Handrail height 34 to 38 inches; and (5) Edge protection

- The cross slope (which is the incline from side to side across the path of travel) of ramp surfaces shall be no greater than 1:50. ADA Std. 4.8.6
- If handrails are mounted adjacent to a wall, the space between the wall and the handrail shall be 1 ½” . ADA Std. 4.26.2

Tips and Solutions for Ramps

Ramps are essential for wheelchair users if elevators or lifts are not available to connect different levels. However, some people who use walking aids have difficulty with ramps and prefer stairs.

A level landing may be part of the sidewalk or walkway. A ramp landing that is not level causes individuals using wheelchairs to tip backward or bottom out when the ramp is approached. Remember that all walkways and ground surfaces along an accessible route must be stable, firm, slip resistant and free of abrupt level changes over ½”.

The area considered to be a level landing at the top or bottom of a ramp will not include the area within the swing of any door.

Edge protection on ramps prevents people and wheelchairs from slipping or rolling off the edge of the ramp.

Cross slopes on any walkway or floor surfaces can cause considerable difficulty in propelling a wheelchair in a straight line, especially on a ramp or otherwise sloped surface.

People with disabilities often rely upon grab bars and handrails to maintain their balance and prevent serious falls. Many people brace their forearms between supports and walls to give them more leverage and stability in maintaining balance or for lifting. The 1½” clearance provides adequate gripping room while helping to prevent injuries that may result from arms slipping through a larger opening.

There is a large selection of pre-built ramps available to fit almost any situation. Ramps may be used as either permanent or temporary solutions.

ELEVATOR REQUIREMENTS

- An accessible route does not include stairs, steps, or escalators. If the building entrance and the voting area are located on different floors of the building, then a ramp, elevator, or platform lift shall be provided. ADA Std. 4.3.8
- Both sides of the elevator hoistway entrance shall have 2" raised letters and Braille character floor designation signs. The characters shall be centered 60" above the floor. ADA Std. 4.10.5
- Call buttons in elevator lobbies and halls shall be centered at 42" above the floor. ADA Std. 4.10.3
- The elevator door must provide at least 36" clear passage. ADA Std. 4.10.9
- The floor area of the elevator must provide enough space for wheelchair users to enter, reach the controls, and exit the car. The minimum depth from the door entrance to the rear of the cab is 54". The width from side to side is 80" for a center door and 68" for a side door entrance. ADA Stds. 4.10.9, 4.10.10 (see figures below)

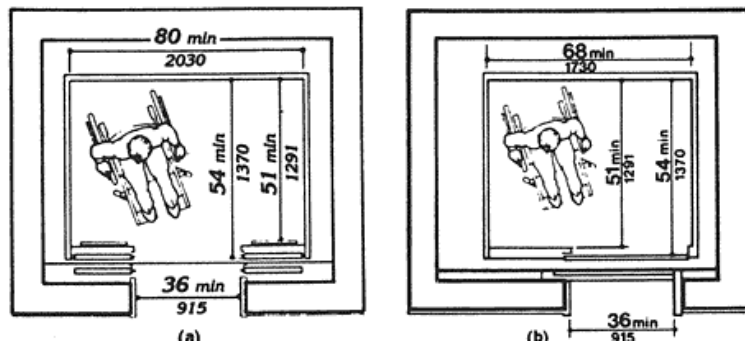

- Raised letters and Braille characters must be used to identify each floor button and each control. ADA Std 4.10.12(2)
- Floor control buttons in the elevator cab should be mounted no higher than 54" for a side reach or 48" for a forward reach. ADA Std. 4.10.12(3)
- The elevator must be equipped with audible tones or bells that announce each floor as it is passed. ADA Std. 4.10.13

- Elevator doors must stay open long enough to enter safely (minimum 5 seconds) and remain open for at least 3 seconds in response to a car call. ADA Stds. 4.10.7, 4.10.8

Tips and Solutions for Elevators

Floor dimensions of at least 48” by 48” may be allowed for elevators in existing facilities built before the ADA went into effect.

People who are blind or visually impaired are trained to find tactile signs in a consistent location. They cannot find the sign if it is not mounted at the correct height.

The amount of time elevator doors must remain open is based on the dimensions of the lobby or corridor outside of the elevator. The larger the lobby area, the longer the doors must remain open in order to give a person a chance to cross the lobby and enter the elevator safely. Refer to ADA Standards for specific information.

PLATFORM OR WHEELCHAIR LIFT REQUIREMENTS

- An accessible route does not include stairs, steps, or escalators. If the building entrance and the voting area are located on different floors of the building, then a ramp, elevator, or platform lift shall be provided. ADA Std. 4.3.8
 - The lift must allow a wheelchair user unassisted entry, operation, and exit. ADA Std. 4.11.3
 - The change in level from the floor to the lift surface must be less than ¼”, or may be up to ½” if beveled. ADA Stds. 4.5.2
 - The clear floor space of the lift must be at least 30” by 48”. ADA Std. 4.2.4
 - The lift controls or operating mechanisms shall not be mounted more than 54” above the floor for a side reach or 48” for a forward reach. ADA Stds. 4.2.5, 4.2.6
 - The lift controls or operating mechanisms must be usable with one hand without tight grasping, pinching, or twisting of the wrist. ADA Std. 4.27.4
-

VOTING AREA REQUIREMENTS

The voting area must conform to the same standards as the interior path of travel.

- Any door leading into or out of the voting area shall be accessible as described in the Building Entrance and Interior Door Requirements section.
 - The voting area should provide adequate space for check in tables, at least one accessible voting booth, and must have an accessible route (36" wide) throughout the voting area.
 - Along the general path of traffic throughout the voting area, there should be no undetectable objects protruding into the walkway (more than 4" out from the wall if an object's bottom edge is higher than 27") or hanging too low into the walkway (lower than 80").
 - The interior floor surface must be relatively level, free from abrupt level changes over 1/2", and must be stable, firm and slip resistant.
-

POLLING PLACE ACCESSIBILITY SURVEY 2006

Section A. Parking Spaces

1. Is parking available (on-street, off-street, or both)?
2. Is the surface of the parking area stable, firm and slip resistant? Please describe.
3. Is any accessible parking identified?
4. Is the minimum number of accessible parking spaces with proper access aisles provided (96" space with 60" aisle or 96" space with 96" aisle for van)? Min. of 1 van space and additional spaces as required.
5. Do van-accessible space(s) provide proper vertical clearance (8'2")?
6. Does each accessible parking space have proper signage?
7. Are all accessible parking spaces and access aisles relatively level (1:50 or 2%) in all directions?
8. If there is a curb between the access aisle and the accessible route is there a curb ramp (as described below)?
 - a. Is the ramp surface at least 36" wide, excluding flared sides?
 - b. Is the slope no more than 1:12?
9. Are the accessible parking spaces on the shortest accessible route to the accessible entrance?

Section B. Sidewalks and Walkways

1. Is there an accessible route and accessible entrance at a primary entrance used by other voters?
2. Is there signage to indicate the route to the accessible entrance?
3. Is the accessible route at least 36" wide? List measurement.
4. Is the accessible route free of steps and abrupt level changes over 1/2 inch?
5. If the accessible route crosses a curb is a curb ramp provided (as described below)?
 - a. Is the ramp surface at least 36" wide, excluding flared sides?
 - b. Is the slope (up or down the curb ramp) no more than 1:12?
6. If the slope of part of the accessible route is greater than 1:20, does this part meet the following requirements for an access ramp?
 - a. Is the ramp slope no greater than 1:12?
 - b. If the vertical rise is more than 6", are handrails provided?
 - c. Are the tops of the handrails mounted between 34 and 38 inches above the ramp surface?
 - d. Are the handrails grippable (less than 2" diameter) and stable within fittings?

- e. Is the ramp width at least 36"? (Measure between handrails when provided.)
- f. Are proper top and bottom landings (60" long) provided for each ramp section?
- g. If a ramp is more than 30 feet long, is a proper level landing (60" long) provided every 30 feet?
- h. Is a proper level landing (60" x 60") provided where a ramp changes direction?
- i. If the ramp or landing has a vertical drop off on either side, is 2" edge protection provided?
- j. Is the cross-slope less than 2%?

7. Are all sidewalks and walkways to the voting area free of any undetectable objects (bottom edge no higher than 27" or protruding from wall more than 4")?

8. Are all objects that hang over the pedestrian routes 80" or more above the route?

9. Are the undersides of exterior stairs enclosed or protected with a cane detectable barrier?

10. Is an accessible route provided from public sidewalks and public transportation stops on the polling site to the accessible entrance of the building?

C. Passenger Drop-Off Areas

1. Is a passenger drop-off area provided? If not, is there an area available that could meet the following requirements: (If yes, please photograph) (If no, go to Section D.)

2. Is the vehicle space relatively level (1:50 or 2% max slope in any direction)?
3. Is a relatively level (1:50 or 2% max slope in any direction) access aisle provided?
4. Is the area for the access aisle at least 60" wide and 20-feet long?
5. Is there proper vertical clearance (9' 6") for the vehicle route to the loading zone, the drop off area, and the exit?
6. If a curb ramp is provided between vehicle pull up area and the access aisle, and/or access route to the accessible entrance does it meet the requirements described below?
 - a. Is the slope of the curb ramp surface no more than 1:12?
 - b. Is the width of the curb ramp surface at least 36 inches?
7. Does an accessible route connect the drop off area to the accessible entrance?

D. Building Entrance

1. Is there signage to indicate the accessible entrance?
2. Does the door at the accessible entrance provide proper passage (32" width)?
3. Does the door have an accessible handle (inside and outside)?

4. Is the door handle located no more than 48" from the floor (measured from center of handle)?
5. Is proper clearance provided on the pull side of the door (18")?
6. If there is a raised threshold, is it no higher than 3/4 inch at the door and beveled on both sides? (Max threshold without beveled edge is 1/2".)
7. Is the force of the door for pushing or pulling easy to operate? Specify force.
8. Is there proper floor space provided if the entry has a vestibule (30" x 48" beyond swing of door)?
9. If vestibule, is second door accessible? Repeat questions 2-7 (9a – 9f).

Section E. Hallways and Corridors

1. Is there an accessible route (36" width) that connects the accessible entrance to the voting area?
2. Is the accessible route free of steps and abrupt, unbeveled level changes over 1/2"?
3. Does the route from the accessible entrance to the voting area change levels using a ramp, lift or elevator? If yes, complete appropriate section.
4. At each location on the way to the voting area where the accessible route passes through a door or doors, does the door meet the following requirements (at least one door for double doors)?

- a. Is clear width at least 32" when door is open 90 degrees?
 - b. Does the door have an accessible handle? (Shape and height)
 - c. Is proper clearance provided on the pull side of the door (18")?
 - d. Is no more than 5 pounds force needed to push or pull open the accessible door?
 - e. If the answers to any of questions (b) thru (d) are "No", can the door be propped open to provide an accessible route on election day?
 - f. If there is a raised threshold, is it no higher than 3/4 inch at the door and beveled on both sides? (Max threshold without beveled edge is 1/2".)
5. Are pedestrian routes leading to or serving the voting area free of any undetectable objects? (Bottom edge no higher than 27" or protruding from wall more than 4")
6. Are all objects that hang over the pedestrian routes 80" or more above the route?
7. Are the undersides of interior stairs enclosed or protected with a cane detectable barrier?

Section F. Ramps

1. Where the slope of the accessible route is greater than 1:20, does this part of the route meet the following requirements for an access ramp?
2. Is the slope no greater than 1:12?

3. If the vertical rise is more than 6", are handrails provided?
4. Are the handrails grippable (less than 2" diameter) and stable within fittings?
5. Are the tops of the handrails mounted between 34 and 38 inches above the ramp surface?
6. Is the ramp width at least 36"? (Measure between handrails when provided)?
7. If a ramp is more than 30 feet long, is a proper level landing (60" long) provided every 30 feet?
8. Are proper top and bottom landings (60" long) provided for each ramp section?
9. Is a proper level landing (60" x 60") provided where a ramp changes direction?
10. If the ramp or landing has a vertical drop-off on either side of the ramp, is 2" edge protection provided?

Section G. Elevators

1. If an elevator is provided, does it meet the following requirements:
2. Are the elevator call buttons mounted in an accessible location (centered 42" above floor)?
3. Are raised letters and Braille characters used to identify each floor button and each control?
4. Are signs mounted on both sides of the elevator

hoistway door opening that designate the floor with 2" minimum-height raised letters and Braille characters centered at 60" above the floor?

5. Does the floor area of the elevator car provide space for wheelchair users to enter, reach the controls, and exit the car?

- a. Side door interior floor measurements:
- b. Center door interior floor measurements:

6. Are the highest floor control buttons in the elevator cab mounted no more than 54" above the floor for a side reach or 48" for forward reach?

7. Is the elevator equipped with audible tones or bells or verbal annunciators that announce each floor as it is passed?

8. Do the elevator doors stay open long enough to enter safely? Indicate time.

Section H. Lifts

1. If a wheelchair lift is provided, does it meet the following requirements:

2. Is the lift operational at the time of the survey?

3. Is the change in level from the floor to the lift surface ramped or beveled or less than 1/2 inch?

4. Is there at least a 30" by 48" clear floor space on the wheelchair lift?

5. Does the lift allow a wheelchair user unassisted entry, operation, and exit?

6. Are the controls and operating mechanisms mounted no more than 54" above the floor for a side reach or 48" for a forward reach?

7. Are the controls and operating mechanisms usable with one hand without tight grasping, pinching, or twisting?

Section I. Voting Area

1. Is there an accessible entrance to the voting area as described below?

a. Is clear width at least 32" when door is open 90 degrees?

b. Does the door have an accessible handle? (Shape and height)

c. Is proper clearance provided on the pull side of the door (18")?

d. Is no more than 5 pounds force needed to push or pull open the accessible door?

e. If the answers to any of questions (b) thru (d) are no, can the door be propped open to provide an accessible route on election day?

f. If there is a raised threshold, is it no higher than 3/4 inch at the door and beveled on both sides? (Max threshold without beveled edge is 1/2".)

2. Within the voting area, is adequate space available on the accessible level for check-in tables, a voting demonstration area (if provided), and at least one

accessible voting station? Describe briefly.

3. Is the voting area free of any undetectable objects?

4. Are all objects that hang over the voting area 80" or more above the ground?

5. Are interior floor surfaces relatively level and free from abrupt level changes? Please describe the floor surface of hallways and voting area.

Section J. Second Voting Area/Other Areas

Repeat questions 1-5 of **Section I**