

STATE OF MAINE  
DEPARTMENT OF AGRICULTURE, CONSERVATION & FORESTRY  
LAND USE PLANNING COMMISSION

IN THE MATTER OF )  
REZONING PETITION ZP 779A ) PRE-FILED DIRECT TESTIMONY  
WOLFDEN MT. CHASE, LLC ) OF WOLFDEN MOUNT CHASE, LLC

VOLUME I OF IV  
(Testimony of Jeremy Ouellette, Douglas Stewart, Gemma-Jayne Hudgell)

## **INDEX OF WITNESSES AND EXHIBITS**

### **VOLUME I**

#### **JEREMY OUELLETTE**

Pre-Filed Direct Testimony

- Exhibit A Chapter 200 Summary
- Exhibit B Statements from CLF and NRCM on Maine’s mining law
- Exhibit C Figure 2-1 conceptual site plan
- Exhibit D LUPC Guidance for Interpreting 2010 CLUP, October 5, 2012
- Exhibit E Summary of Wolfden Community Engagement
- Exhibit F Town of Hersey Mining Ordinance and Special Town Minutes from October 6, 2022
- Exhibit G Town of Patten – Special Town Meeting Minutes, April 13, 2023
- Exhibit H Town of Sherman – Resolution in Support of Wolfden Resources, April 4, 2023
- Exhibit I Town of Stacyville – Resolution in Support of Wolfden Resources, January 18, 2023
- Exhibit J Moro Plantation – Special Town Meeting Minutes, December 14, 2022
- Exhibit K Passamaquoddy THPO Comments to LUPC
- Exhibit L Maine Geological Survey Comments to LUPC

#### **DOUGLAS STEWART**

Pre-Filed Direct Testimony

- Exhibit A Curriculum Vitae
- Exhibit B Wolfden Regional Location Map
- Exhibit C Penobscot River Watershed Map
- Exhibit D Correspondence with MDIFW, September 25, 2023

#### **GEMMA-JAYNE HUDGELL**

Pre-Filed Direct Testimony

- Exhibit A Curriculum Vitae
- Exhibit B Northeast Archaeological Research Center Archaeological Phase 0 Assessment

### **VOLUME II**

#### **MARK PETERS**

Pre-Filed Direct Testimony

- Exhibit A Curriculum Vitae
- Exhibit B Wood (now WSP) Technical Memorandum

#### **BRIAN DANYLIW & PAUL THOEN**

Pre-Filed Direct Testimony

- Exhibit A Curriculum Vitae Danyliw



Exhibit B Curriculum Vitae Thoen  
Exhibit C Mine Water Service Water Treatment Report

**LISA TURNER**

Pre-Filed Direct Testimony

Exhibit A Curriculum Vitae  
Exhibit B Sevee & Maher Engineers Technical Memorandum, December 19, 2022  
Exhibit C Sevee & Maher Engineers Response to LUPC Comments, April 12, 2023  
Exhibit D Spray Irrigation Systems and Equipment  
Exhibit E Snowmaking Systems and Equipment

**JIM FINLEY**

Pre-Filed Direct Testimony

Exhibit A Curriculum Vitae

**DON DUDEK**

Pre-Filed Direct Testimony

**VOLUME III**

**RONALD LITTLE**

Pre-Filed Direct Testimony

**BRIAN LeBLANC**

Pre-Filed Direct Testimony

Exhibit A Curriculum Vitae  
Exhibit B Overview of AMPL  
Exhibit C Preliminary Economic Assessment Cover Page and Table of Contents

**SEAN FIELER**

Pre-Filed Direct Testimony

**VOLUME IV**

**MICHAEL LeVERT**

Pre-Filed Direct Testimony

Exhibit A Curriculum Vitae  
Exhibit B Economic Assessment of the Proposed Project, November, 2022

**TERRY THURSTON-HILL**

Pre-Filed Direct Testimony

STATE OF MAINE  
DEPARTMENT OF AGRICULTURE, CONSERVATION & FORESTRY  
LAND USE PLANNING COMMISSION

IN THE MATTER OF	)	Pre-Filed Direct Testimony of Douglas B.
REZONING PETITION ZP 779A	)	Stewart on Behalf of Wolfden Mt.
WOLF DEN MT. CHASE, LLC	)	Chase, LLC

On behalf of Wolfden Mt. Chase, LLC (“Wolfden”), Douglas B. Stewart is submitting this pre-filed direct testimony in support of ZP 779A.

**I. QUALIFICATIONS AND EXPERIENCE**

I am an environmental scientist with 30 years of professional experience working as an environmental consultant in Maine. I hold a B.S. in Natural Resources from the University of Maine, Orono. My work focuses on a wide range of environmental studies that include wetlands, waterbodies, threatened and endangered species surveys, soil, surface water, and groundwater evaluations, wetland and stream restoration, ecological risk assessments, natural resource damage assessments, and related permitting and regulatory approvals. I have prepared and supported numerous applications for State and federal agencies approvals in Maine, including applications to the Maine Land Use Planning Commission and Maine Department of Environmental Protection. I am a Certified Wetland Scientist (#1823) with the Society of Wetland Scientists, and a Maine Licensed Site Evaluator (#349). I am an active member in the Society of Wetland Scientists and the Maine Association of Wetland Scientists. I have spent much of my career working on natural resource evaluations and impact assessment for energy/infrastructure projects. Those projects have included mine sites in Maine, Pacific Northwest, Rocky Mountain West, and South America.

My *curriculum vitae* is included in Exhibit A.

## **II. INVOLVEMENT WITH THE PICKETT MOUNTAIN PROJECT**

I became involved with the Pickett Mountain Project (Project) in January of 2022 and was involved in coordinating and preparing the LUPC Rezoning Application (Application). This testimony is being prepared with the input from the numerous environmental subject matter experts who contributed to the Application. As a lead for the various environmental subject matter experts, I have been involved with the design and implementation of the various studies, and analyses and documentation associated with the Project. My testimony will summarize the information collected and evaluated to characterize the existing ecological conditions of the Rezone Area (Project Area) and analysis conducted to evaluate the potential ecological impacts of the Project.

The design and implementation of field studies and environmental impact analysis has involved many specialists from Stantec, other consultants retained by Wolfden, and input from state and federal regulatory and resource agencies such as Maine LUPC, Maine Department of Inland Fish and Wildlife, and Maine Department of Environmental Protection (DEP). Where other specialists have been involved in the implementation of field efforts and analysis, it will be noted in this testimony. If there are specific questions on studies prepared by others, it may be more appropriate to have those experts respond to specific questions. These experts will be available at the public hearing to answer questions.

The purpose of this testimony is to provide context for understanding the resources that might be impacted by the Project and demonstrate the manner in which the Application considered the full range of environmental issues and avoids and minimizes potential impacts through the current design. The final design and preparation of a mining permit application will require substantial additional resource and other data collection; the work completed to date will

be supplemented with additional information collected as part of the comprehensive DEP permitting process.

### **III. SITE OVERVIEW AND PROJECT CONTEXT**

The Project Area proposed for rezoning for the Pickett Mountain Project is approximately 374 acres in T6 R6, Penobscot County. Approximately 129 acres of the Project Area is anticipated to be cleared for the project. The Project Area is located within a larger 7,145 acres parcel owned by Wolfden. There are no residences within the Project Area; the closest residences are seasonal camps approximately 1 mile away in the vicinity of Pleasant Lake. Except for commercial forestry activities, there are no businesses within 3 miles of the Project Area.

The Project Area is bisected by existing forest management roads, is forested, and was harvested in the past 10 years. The surrounding land is also actively managed for timber production. The Project Area is dominated by forested upland, with several large, forested wetland complexes and many smaller wetlands throughout. There is a large hill in the southwest portion of the Project Area, and topography slopes to the north and to the east through much of the Project Area.

Areas surrounding the Project Area are commonly used for recreational activities such as hunting, fishing, ATVs, and snowmobiling. Some of the waterbodies beyond the Project Area that are easily accessible for recreation include Pleasant Lake, Pickett Mountain Pond, Mud Pond, Tote Road Pond, and Grass Pond, and West Branch of the West Branch Mattawamkeag River. There are no public lands or conservation lands within 3 miles of the Project Area. The broader region (beyond three miles) includes major recreational resources like the Katahdin Woods and Waters National Monument (5+ miles) and Baxter State Park (15+ miles), and

numerous lands and ponds.

The LUPC Comprehensive Land Use Plan (CLUP) acknowledges that a mining project depends on the presence of a natural resource and does not require the area to be adjacent to existing developed areas.<sup>1</sup> Consistent with more general development objectives, the Project is at the edge of LUPC jurisdiction and not in its remote core. *See* Exhibit B. T6 R6 is proximate to the organized towns of Patten and Hersey. Patten is a rural hub and is located approximately nine miles from the Project.<sup>2</sup> The town of Hersey is two miles from the Project. Almost the entirety of Mount Chase, which borders T6 R6 to the south, is a primary or secondary location. Likewise, a significant portion of Moro Plantation, which borders T6 R6 on the east, is a primary location. Route 11 is 4.4 miles from the Project. The map attached as Exhibit B depicts the region surrounding the Project.

#### **IV. NATURAL RESOURCES**

Prior to initiating any desktop or field studies of the Project Area, we reached out to key natural and historical resource agencies (US Fish and Wildlife; Maine Department of Inland Fisheries and Wildlife; Maine Department of Environmental Protection; Maine Natural Areas Program; Maine Historic Preservation Commission) as well as the tribes of Maine (Penobscot Nation; Passamaquoddy Tribes; Houlton Band of the Maliseet Indians; Aroostook Band of the Micmac Indians) to determine if there were any known resources of concern in the Project Area. Those correspondences are presented in Attachments 25 and 26 of the Application.

Preliminary resources studies completed include a wetland and watercourse field survey; viewshed and line of sight analyses; a noise assessment; a soil suitability evaluation; a desktop

---

<sup>1</sup> CLUP § 5.7.C (p.219).

<sup>2</sup> LUPC, *Map of Primary and Secondary Locations Based on the Adopted Rule* (Apr. 19, 2019), [https://www.maine.gov/dacf/lupc/projects/location\\_of\\_development/AdjacencyConcepts\\_April2019\\_Adopted.pdf](https://www.maine.gov/dacf/lupc/projects/location_of_development/AdjacencyConcepts_April2019_Adopted.pdf).

botanical analysis; and a Phase 0 archaeological field survey. I will address the resource surveys; Northeast Archaeological Research Center Inc. will provide testimony regarding the Phase 0 and historical resources. No wildlife specific surveys were conducted, but wildlife is discussed further below and is based on information provided by Maine Department of Inland Fisheries and Wildlife. Each of these resources will be addressed in more detail under the Chapter 200 permitting process.

### **A. Wetland and Watercourse Resources<sup>3</sup>**

The Project Area is generally dominated by forested uplands with several large, forested wetland complexes and smaller isolated wetlands throughout. The Project Area does not contain lakes, ponds, or rivers. A surface water divide occurs along the ridge that separates surface water flow to Pickett Mountain Pond and Pleasant Lake. The watershed surrounding and contributing to Pickett Mountain Pond is approximately 2,095 acres. In comparison, the watershed surrounding Pleasant Lake and Mud Lake is approximately 8,389 acres. Pickett Mountain Pond outlet flows eventually to Mud Lake and creates a combined watershed with a drainage area of approximately 10,485 acres. The map attached as Exhibit C depicts the waterbodies in the vicinity of the Project Area and the larger Penobscot watershed.

The 129-acre project is located within the 71 square mile West Branch of the Mattawamkeag River watershed, part of the 1,500 square mile Mattawamkeag River watershed. The Mattawamkeag River ultimately joins the Penobscot River approximately 100 river miles from the project site. *See Exhibit C.*

---

<sup>3</sup> See Application Attachment 6-A *Wetland and Watercourse Delineation and Potential Vernal Pool Survey Report, July 28, 2022.*

Numerous watercourses (ephemeral, intermittent, and perennial streams) are located within the Project Area. A wetland and vernal pool survey was completed at the Project Area by WSP, during the seasonally appropriate periods, in 2020. Additional wetland delineations and field verifications were completed by Stantec in June 2022. Within the Project Area, 29 wetlands, 22 watercourses, 8 vernal pools and 2 potential vernal pools (PVPs) were identified during these surveys.

Mine infrastructure in the Project Area is sited at least 75 feet away from wetlands, streams, and VPs/PVPs to avoid direct impacts to these resources during construction and mine operations. As detailed in testimony provided by Brian Danyliw, Paul Theon and Lisa Turner, the Project's water treatment approach will return clean, treated water back to the environment using Water Recharge Areas (WRAs). The siting and release of water from these WRAs is designed to maintain current hydrology to wetlands, streams, and VPs/PVPs within the Project area and downgradient water bodies such as Pickett Pond, Mud Lake, and Pleasant Lake. As a result, the Project does not anticipate any adverse impacts to these resources. Further studies related to characterizing the wetlands, waterbodies, and vernal pools will occur as part of Chapter 200 design and permitting process.<sup>4</sup>

## **B. Viewshed and Line of Sight Analyses<sup>5</sup>**

To understand potential visibility of the Project, Stantec used digital elevation models focused on the elevation of the tallest project structure, the headframe, to create a Viewshed Analysis of the Project Area from roadways, scenic byways, major waterbodies, coastal wetlands, permanent trails, and public property within 3 miles. The headframe will be

---

<sup>4</sup> See, e.g., 06-096 C.M.R. Ch. 200, § 9(C)(3)(c)-(d) (requiring characterization of baseline water quality in streams, ponds, and wetlands).

<sup>5</sup> See Application Figures 16-1 and 16-2, Viewshed Analyses, and Attachment 16-A, *Line of Sight Analysis from Pleasant Lake*, October 13, 2022.



approximately 120 feet above ground level. The headframe is a structural frame above the underground mine shaft that enables the hoisting of materials to the surface. Headframes are typically constructed out of steel or concrete or a combination of the two materials. The headframe at the Pickett Mountain Mine will extend 120 feet above the ground and is estimated to extend approximately 80 feet above the tree line. The next tallest feature, the low-grade ore storage area, is approximately 65 feet above ground level and all buildings are 30 feet or less tall. Two versions of the model were run on the 120-foot headframe, one assumed bare ground, no forest canopy (Figure 16-1) and the second assumed a 40-foot forest canopy (Figure 16-2). The latter model found the potential for visibility of the headframe from spots on the snowmobile/ATV trail immediately south of the Project Area; Pickett Mountain Pond; the northern shore of Pleasant Lake; and, based on field observations, the summit of Mount Chase. Due to distance and intervening topography, there would be no visibility from Katahdin Woods and Waters National Monument, Katahdin Woods and Waters Scenic Byway, or Baxter State Park.

To further evaluate the potential view from a cluster of camps on Pleasant Lake, TJD&A of Yarmouth (now Viewshed) conducted a line-of-sight analysis for both the headframe and the proposed solar array. They concluded that intervening vegetation would block views of the solar array, and that only filtered views of the headframe would occur at a distance of 1.5 to 2 miles from the camp locations.

### **C. Noise Assessment<sup>6</sup>**

Wood Environment & Infrastructure Solutions (Wood) (now WSP), completed a noise assessment to evaluate the sound impact of the Project on the closest residences, recreational

---

<sup>6</sup> See Application Attachment 16-B, *Noise Assessment*, October 12, 2022.

areas and property lines. They determined the sound levels created by project activities (trucking, loading, generators, fans), assumed each of those sound sources were operating simultaneously, and then modeled the decibel impact those sounds would have on the closest resources. The rezone area is within a larger 7,135-acre parcel owned by Wolfden; the closest protected location is a seasonal camp 4,000 feet away on the south shore of Pleasant Lake. The modeled sound levels from the project are significantly below Maine DEP and LUPC sound standards, a conclusion confirmed by LUPC's third party consultant, Tech Environmental.<sup>7</sup>

#### **D. Soil Suitability<sup>8</sup>**

Watershed Resource Consultants, LLC (WRC) conducted a soil suitability review based on information and data gathered from a wide range of sources, including existing published Natural Resources Conservation Service (NRCS) soil surveys, LiDAR topography, geotechnical drilling data from past explorations and onsite field review of the soils by certified soil scientists. The purpose of the review was to evaluate whether soils are generally suitable for the proposed development. In addition to desktop evaluation of NRCS soils data, field investigations including more than 30 soil test pits and dozens of auger borings were conducted across the Project Area to verify and refine NRCS information.

The evaluation concluded that the Project Area contains soils that are either generally suitable or have limited suitability for the proposed development. The areas of limited suitability include shallow bedrock conditions, and areas with a seasonal high-water table. The report concluded that these can be overcome using standard engineering practices that have been used successfully on many other projects. LUPC's third party reviewer David Rocque, agreed that, for the most part, the project is sited on soils generally suitable for development and that a high

---

<sup>7</sup> See May 12, 2023, Tech Environmental comments to LUPC.

<sup>8</sup> See Application Attachment 23-A, *Soil Suitability Report*, September 2022.

intensity soil survey, required by Chapter 200, will provide the further information needed to do final siting and design. Mr. Rocque suggested construction techniques to maintain hydrology of the surface waters that were used successfully in the Kibby Wind project and those techniques will be incorporated into the final Project design.

### **E. Botanical Analysis<sup>9</sup>**

Although an inquiry to the Maine Natural Areas Program did not reveal any records of rare or exemplary botanical features in the Project Area, Stantec used publicly available information, aerial imagery, topography, bedrock geology and onsite data to further evaluate the likelihood of rare plants in the Project Area. The analysis found that the forest communities were typical of areas harvested for timber, and that the lack of indicator species present in field data collected during wetland surveys leads to a conclusion that the site has a low to very low potential to support rare or exemplary botanical resources.

### **F. Wildlife Habitat and Resources**

There are no deer wintering areas, no inland waterfowl and wading bird habitats, no significant wildlife habitats in the Project Area. Beyond the Project Area, an inland waterfowl and wading bird habitat (IWWH) was identified at the western portion of Pickett Mountain Pond by the Maine Department of Inland Fisheries and Wildlife (MDIFW) in their July 27, 2022, letter presented in Exhibit 26 of the Application. However, based on re-evaluation of this habitat by MDIFW in September 2023, this IWWH falls below the criteria to be considered a Moderate or High Valued IWWH and is not a significant wildlife habitat. *See Exhibit D.* We look forward to continuing the dialog to minimize wildlife impacts as further resource surveys, project siting, facility design/layout, and operational practices are all developed during the Chapter 200

---

<sup>9</sup> See Application Attachment 26-C, MNAP Correspondence and Attachment 26-E, *Botanical Desktop Assessment*, August 31, 2022.

process. Based on known information, and anticipating continued and more detailed consultation should the project proceed, they note in their most recent correspondence that they do not object to rezoning of the Project Area.<sup>10</sup>

### **G. Aquatic Resources**

The Project Area is located west of Pickett Mountain Pond, which flows to Grass Pond, then to Mud Lake. It is also east and south of the West Branch of the Mattawamkeag River, which flows from Pleasant Lake, Mud Lake, Duck Pond, Rockabema Lake. Information on known aquatic resources was provided by the MDIFW in their letter dated July 27, 2022. To date, no site-specific aquatic resource studies have been completed. Additional studies are anticipated to be required under Chapter 200.

Pickett Mountain Pond is located approximately 1,500 feet east of the Project Area and has a maximum depth of seven feet. The initial fisheries survey in 1958 indicated that the inlet tributary had no potential for brook trout spawning, rearing, or adults, and the outlet had little potential. One brook trout was captured during the initial survey, none in subsequent surveys in 1996 and 2004. Pleasant Lake, Mud Lake, and Grass Pond are located to the north and northeast and are designated as Heritage Fish Waters. The Heritage Water designation is assigned to lakes or ponds that contain a self-sustaining population of Brook Trout or Arctic Charr and have not been stocked in at least 25 years. MDIFW manages these resources to be self-sustaining fisheries.

The wetland and waterbodies located in the Project Area eventually flow into the aforementioned ponds and lakes. The Project design does not result in any direct impacts to wetlands and waterbodies. Indirect impacts to aquatic resources will also be avoided based on

---

<sup>10</sup> See June 27, 2023, MDIFW comments to LUPC.

the testimony from WSP, SME and Mine Water Services describing how water will be collected from the mine and Project Area, treated to background conditions, and released back into the watershed via Water Recharge Areas so that the hydrology of nearby wetlands and waterbodies remains unchanged.

## **V. NATURAL CHARACTER**

The Project and surrounding areas are predominantly commercial forests that were harvested within the last 10 years and are now regenerating. A series of access roads maintained by logging companies penetrate the forested areas, allowing access by forestry equipment such as skidders and logging trucks. A network of logging access roads and remnants of old and recent skidder trails are present throughout the Project Area. There are no existing structures in the Project Area. Commercial logging is expected to continue in surrounding areas.

While uses on a portion of the rezone area will change, the Project will have minimal impact on the natural character of the surrounding area:

- The Project has limited visibility and no significant sound impacts;
- No significant wildlife habitat is impacted;
- No wetlands or streams will be adversely impacted;
- Aquatic habitat and hydrology will be maintained;
- Potential impacts from on-site activities will be mitigated by the 400-foot undisturbed buffer that is part of the Project Area;
- The operation of a below ground mine will minimize surface disturbance;
- After operations cease, the site will be restored to its pre-mining state. Buildings and equipment will be removed, the site will be restored to natural contours and revegetated; and,
- Following mine closure and site restoration, monitoring will continue to ensure that there are no adverse impacts to water resources.

Dated: 9/25/23

*Doug B Stewart*  
Douglas B. Stewart

STATE OF MAINE  
County of Cumberland

Date: 9/25/23

Personally appeared before me the above named Douglas B. Stewart, who, being duly sworn, did testify that the foregoing testimony was true and correct to the best of his knowledge and belief.

Before me,

*Suzette M SASS*  
Notary Public  
My commission expires: 1-28-28

**SUZETTE M. SASS**  
Notary Public, State of Maine  
My Commission Expires Jan. 28, 2028

# **EXHIBIT A**

## Douglas Stewart PWS

Senior Principal, Environmental Services Practice  
30 years of experience · Topsham, Maine

Doug is a Professional Wetland Scientist and Ecologist with over 30 years of professional natural resource consulting experience. He is a Senior Principal with Stantec's Environmental Services Practice and works extensively on large scale energy and infrastructure projects, both domestically and internationally. Doug's work focuses on natural resource characterization in terrestrial and aquatic environments, ecological impact assessments, ecological restoration, ecological risk assessment, National Environmental Policy Act, Clean Water Act (Section 401, 404, and 408) Permitting, Emergency Planning and Response, Natural Resource Damage Assessments, expert witness testimony, and third-party reviews. He has authored several publications on ecological sampling and analysis, quantification of ecological impacts, risk assessment, ecological restoration, and eDNA, and he regularly presents on these topics at conferences in the US and abroad.

### EDUCATION

B.S., Natural Resources, Concentration in Soil Science, College of Applied Sciences and Agriculture, University of Maine, Orono, Maine, 1993

Wetlands Identification and Delineation, University of New Hampshire, Durham, New Hampshire, 1998

### CERTIFICATIONS & TRAINING

40-Hour Hazwoper Certification, OSHA, Topsham, ME, 1993

8 Hour Hazwoper Refresher , OSHA, Topsham, ME, 2019

### REGISTRATIONS

Professional Wetland Scientist #1823, Society of Wetland Scientists

Licensed Site Evaluator #349, State of Maine

### MEMBERSHIPS

Member, Society of Wetland Scientists

Member, Ecological Society of America

Member, U.S. Environmental Protection Agency, New England Association of Environmental Biologists

Member, The Wildlife Society, Maine

Member, Association of State Wetland Managers

Member, Maine Association of Wetland Scientists

Member, Maine Association of Site Evaluators

### SELECTED PROJECT EXPERIENCE

Callahan Mine Superfund Site Ecological Characterization and Restoration| Brooksville, Maine | Principal Scientist

Starting in 2005, completed large-scale ecological characterization and extensive field studies in support of ecological risk assessment and removal/restoration activities at the site of a former copper and zinc mine located directly on the coast of Maine. Provided evaluations of terrestrial and aquatic communities and ecological impacts through field surveys, biota and sediment sampling, modeling, and statistical analysis. Supported development of the ecological risk assessment for the project and provided technical support in sampling design and data analysis. More recently, Doug has supported site restoration planning and implementation activities including restoration of upland habitat and saltmarsh wetlands.

Remedial Investigation and Wetland and Stream Restoration, Former Loring Air Force Base | Limestone, Maine | Principal Wetland Scientist and Project Manager

As part of the Loring CERCLA program, planned, designed, and constructed the ecological restoration of 2.5 miles of high value brook trout stream and over 50 acres of freshwater wetlands following sediment removal actions. Doug's work on this project has extended over the past 30 years—baseline ecological data collection was initiated in 1993 and completed in 1995; ecological and human health risk assessments were completed in 1995-1996, wetland and stream restoration design was completed in 1996-1997, sediment removal action was completed in 1997-1998, wetland and stream restoration was completed in 1998-1999. Long-term biological and wetland monitoring was initiated in 1999 and is ongoing in 2023.

This project, one of the largest and most complex sediment removal actions and ecological restoration projects in the northeast, is used as an example of successful wetland and stream restoration by both the scientific community and state and federal resource agencies. Over 20 years since restoration construction was completed, long-term monitoring demonstrates that wetland functions and values have been successfully restored, and a diverse assemblage of stream and wetland communities are present.



**P310/P381 Dry Dock No. 1 Super Flood Basin Project | Portsmouth Naval Shipyard | Kittery, Maine | Principal Scientist**

Doug coordinated with the design engineering team and lead the environmental team to delivered permits and successfully meet the project construction schedule. The project included dredging over 3 acres of subtidal area to construct closure walls and create a new dry dock basin. Environmental assessment and permitting for state and federal approvals were completed for this project. This work included the dredge characterization and waste disposal selection. Stantec developed and completed a sediment sampling program to characterize proposed dredge materials for their suitability for licensed waste facilities, on-site beneficial use and USACE ocean disposal sites. Field surveys included wetlands, eel grass, and threatened and endangered species. A Marine Mammal monitoring App was developed to collect observation data on marine mammals during construction and create efficient reporting to the National Marine Fisheries Service.

**Buoyancy Control Measure Installation Design and Permitting, Portland-Montreal Pipe Line | Portland Pipe Line Corporation | Maine, New Hampshire, Vermont, and Quebec | Principal**

For Portland Pipe Line Corporation (PPLC), Doug coordinated and lead the Stantec engineering and environmental teams to successfully design and obtain the environmental permits necessary to install buoyancy control measures along a 250 mile pipeline that extends through Maine, New Hampshire, Vermont, and Quebec. This involved extensive coordination and collaboration with our US and Canadian pipeline design and environmental teams. Doug advised the Client team with strategic advice to obtain federal and state agencies, including the U.S. Army Corps of Engineers, multiple divisions within the Maine Department of Environmental Protection, New Hampshire Department of Environmental Services, Vermont Department of Environmental Conservation, and Vermont Natural Resources Board.

**Idlewild Acres USEPA Wetland Alteration Settlement | Cape Cod, Massachusetts | Principal Wetland Scientist**

Lead the settlement in response to a USEPA enforcement action and subsequent consent decree regarding unauthorized conversion of cranberry bogs on Cape Cod, Massachusetts. Stantec conducted a baseline assessment to characterize existing site conditions and a historic records review to identify wetland conditions and the associated functions that existed at the site prior to the disturbances. Appropriate wetland restoration goals and objectives were identified for 2.7 acres of wetland area. Using the collected groundwater data and available LiDAR data, Stantec identified target surface elevations that would provide for wetland hydrology of the restoration site as well as restore flood storage capacity. Following the groundwater monitoring study, Stantec prepared a wetland restoration plan detailing measures to restore wetland area and functions, particularly flood storage capacity, wetland hydrology, and vegetation while accommodating ongoing use of the wetland areas for commercial agriculture. The plan was approved by the USEPA. Stantec continues to conduct annual post-construction monitoring.

**York Wetland Restoration | Biddeford, Maine | Principal Wetland Scientist and Project Manager**

Developed a conceptual stream and wetland restoration plan for a 16-acre stream/wetland restoration site and 200-acre wetland/threatened and endangered species preservation site. Work performed on this site included wetland and vernal pool mapping, threatened and endangered species surveys, and conceptual wetland restoration and creation planning.

**City of Brewer Penobscot River Bank Stabilization Project | Brewer, Maine | Project Manager and Principal Scientist**

Directed ecological surveys to characterize the coastal wetland resources affected by the construction of a multi-use recreational trail, upgrade of an existing boat launch, and stabilization of a mile of riverbank along the east shore of the Penobscot River between the Interstate-395 Bridge and the Penobscot River Bridge in Brewer. Surveys focused on the intertidal and subtidal areas directly impacted by the proposed work, as well as areas within 25 feet of the limit of work. Also conducted Essential Fish Habitat and Endangered Species assessments and a characterization of fisheries and wildlife resources that could be affected by the proposed project. Developed a mitigation strategy for mitigating for riverine impacts associated with this site that included a fish passage restoration project. Completed Maine Natural Resources Protection Act and Corps CWA Section 404 permit.

**Newell Brook Stream and Wetland Restoration | New Portland, Maine | Project Manager and Principal Scientist**

Performed ecological surveys to collect information on a 10-acre wetland violation in western Maine. Post-alteration baseline information collected included wetland communities, existing site elevations, and reference site characterizations to support the preparation of the Stream and Wetland Restoration Plan. Prepared, submitted, and negotiated a Stream and Wetland Restoration Plan with the Maine Department of Environmental Protection for review. Performed continuous oversight during stream and wetland restoration activities, oversaw the re-soiling and re-vegetation of the site, and conducted the annual long-term monitoring required by state and federal permits issued for the project.

**University of Maine, Orono, USEPA Enforcement Action and Wetland Restoration Project | Orono, Maine | Principal Wetland Scientist and Project Manager**

Lead the response to an USEPA enforcement action associated with the unpermitted alteration of several acres of wetlands and other regulated resources. Work completed to date includes an assessment of historical wetland impacts across the 2,000-acre site, negotiation of the USEPA Administrative Order, and development of a restoration plan for approximately 8 acres of wetland restoration. Additional work for the University has included Inland Wading Bird and Waterfowl surveys, regulatory jurisdictional determinations, wetland characterizations, threatened and endangered species surveys, wetland delineations across the entire property, wetland alteration permitting, development of a wetlands training program, and wetlands restoration/creation design. Also completed after-the-fact Corps CWA Section 404 permitting and Maine Natural Resources Protection Act Permitting.

**Nalcor, Lower Churchill Hydroelectric Project | Labrador, Newfoundland | Principal Wetland Scientist**

Conducted wetland mitigation planning for impacts associated with the proposed 2,000-megawatt Lower Churchill Hydroelectric Dam. Conducted extensive literature searches for successful wetland and habitat mitigation associated with large-scale hydroelectric facilities throughout North America. Conducted site searches for wetland and species-specific mitigation for an estimated 15 square kilometers of habitat impacts. Completed inventory of potentially suitable sites along the 200-kilometer study area and prepared probable opinion of costs associated with the identified sites.

**Israel 6th Pipeline Protection and Streambank Stabilization Design and Permitting | Portland Pipe Line Corporation | Lancaster, New Hampshire | Principal**

For Portland Pipe Line Corporation (PPLC), Doug coordinated and lead engineering and environmental services that included natural resource assessments and reporting, geotechnical surveys and engineering design, and environmental permitting to address necessary pipeline protection and streambank stabilization associated with three existing pipelines that cross Israel River ("Israel 6th") in Lancaster, New Hampshire.

**Maine Army National Guard Canada Lynx Surveys | Caswell, Maine | Project Manager and Principal Scientist**

Conducted presence/absence surveys for the federally listed Canada lynx. Using remote digital game cameras and bait/lure stations, Stantec surveyed the 2,000-acre Caswell Training Facility to determine if Canada lynx were present. Following these surveys, met with the USFWS to discuss the results to develop an Endangered Species Management Plan required under the Endangered Species Act for this training facility.

**Pease International Tradeport Biological Monitoring and Analysis | Portsmouth, New Hampshire | Project Manager**

Conducted biological monitoring and sampling efforts associated with remediation sites as part of the former Pease Air Force Base CERCLA program. Work included sampling tissue in eel and fish species to determine contaminant concentrations to be used in a human health risk assessment.

**Boothbay Region Water District Expansion | Boothbay and East Boothbay, Maine | Project Manager and Principal Scientist**

Conducted ecological surveys of the Adams Pond and Knickerbocker Lake watersheds. Developed a creative permit approach and lake water management strategy that was used to obtain Maine Natural Resources Protection Act and Corps CWA Section 404 permits.

**Nestle Waters of North America (Poland Spring) Ecological Surveys, Biological Monitoring, Permitting, and Mitigation Planning at Multiple Spring Sites | Poland Spring Bottling Company | Maine | Project Manager and Principal Scientist**

Completed ecological surveys for a spring water bottling company at nine sites throughout Maine. Work included wetland delineations, vernal pools, wetland functional assessments, wading bird and waterfowl surveys, rare plant surveys and natural community characterizations, and fish and fish habitat surveys in association with spring water site development. Work on these spring sites included preparing permit applications for various agencies including Maine Land Use Planning Commission, Maine Department of Environmental Protection, and US Army Corps of Engineers (Section 404). Also provided expert witness testimony at multiple municipal and Land Use Regulatory Commission public hearings.

**Maine Army National Guard Integrated Natural Resource Management Plan | Maine Army National Guard | Maine | Project Manager**

Completed Integrated Natural Resource Management Plans (INRMP) at the Bog Brook, Loring, and Caswell training facilities to guide the management of natural resources at each training facility and ensure that the management strategy was compatible with military training and other activities. Conducted ecological surveys consisting of flora and fauna surveys, including surveys for rare, threatened, or endangered species; stream and wetlands characterizations; invasive species mapping and management; wildlife habitat mapping; wildlife population surveys; natural community mapping; and erosion surveys. Developed land use and endangered species management plans that balance the protection of high value resources with military operations at each of these sites. This INRMP was used as the example management plan for all other National Guard Installations across the US.

**Cabela's Ecological Surveys, Wetland Mitigation Planning, and Permitting | Scarborough, Maine | Project Manager and Principal Scientist**

Completed ecological surveys, including rare plant surveys, wading bird and waterfowl habitat surveys, wetland and vernal pool surveys, and functions and values assessments, on an extensive project area proposed for commercial development. Conducted mitigation site searches and developed and negotiated a mitigation strategy for over 5 acres of wetland and other regulated resource impacts. Subsequent work included mitigation design and construction of a 5-acre wetland creation site. Completed Corps CWA Section 404 permitting and Maine Natural Resources Protection Act permitting.

Megantic Hunting and Fishing Club Ecological Surveys and Permitting | Seven Ponds Township and Massachusetts Gore, Maine | Project Manager and Principal Scientist

Completed ecological surveys at four dam sites in northwestern Maine. Work included vernal pool surveys, wetland functional assessments, wading bird and waterfowl habitat surveys, rare plant surveys, and fish and fish habitat surveys. Completed mitigation sites searches, mitigation planning, vernal pool restoration, and agency negotiation for impacts to regulated resources. Completed Maine Land Use Planning Commission and Corps CWA Section 404 permitting for dam rehabilitation.

Wyman Blueberry Biological Monitoring | Hancock County, Maine | Senior Scientist and Project Manager

Completed ecological surveys including wetlands mapping, wetland functional assessments, rare plant surveys and natural community characterizations, and long-term monitoring of stream and wetland resources in association with feasibility studies for the development of agricultural water withdrawal the project site.

Kinder Morgan Connecticut Expansion Natural Gas Pipeline – Environmental Compliance Monitoring | Sandisfield, Massachusetts | Principal

As a condition of approval for the Connecticut Expansion Natural Gas Pipeline project and on behalf of the Massachusetts Department of Conservation and Recreation (DCR), Stantec was contracted by Tennessee Gas Pipeline Company LLC, a subsidiary of Kinder Morgan, to perform construction observation as a third-party environmental monitor of compliance with environmental approvals and permits along approximately 2 miles of the project that occurs on land managed by DCR in Sandisfield, Massachusetts. Construction observation occurred between May 1 and mid-December 2017 and included evaluation and third-party reporting of project compliance with the following environmental approval and permits: Federal Energy and Regulatory Commission (FERC) Certificate, National Pollution Discharge Elimination System Construction General Permit, Clean Water Act Section 404 permit, 401 Water Quality Certification, Massachusetts Wetlands Protection Act Order of Conditions, and Massachusetts Environmental Policy Act Certificate.

Hurricane Harvey Natural Resource Damage Assessment | Gregory, Texas | Principal

In the wake of Hurricane Harvey, Stantec was retained to evaluate pre-existing infrastructure along Campano Bay for potential damages to the environment. Rapid assessment aerial surveys were completed in the days following the hurricane and post-hurricane conditions were compared to pre-hurricane documents prepared by others.

Natural Resource Advisory Role in Oil Spill Response, Large Interstate Oil Spill | Gulf of Mexico | Principal

Principal scientist for a segment of the project on federal lands where Stantec conducted environmental oversight of the oil spill cleanup activities in compliance with an emergency consultation under Section 7 of the Endangered Species Act. NRA Team assisted our client client, USCG, USFWS, NOAA, and state natural resource agencies with the development and implementation of Best Management Practices (BMPs) to minimize secondary impacts of the cleanup activities on protected resources, including sea turtles, migratory and nesting shorebirds, beach mice, mangrove wetlands, estuaries, coastal wetlands, and dune systems. Responsible for conducting regular consultations with USFWS Section 7 liaisons and state environmental coordinators as part of the Natural Resources Damage Assessment (NRDA).

## SELECTED PUBLICATIONS AND PRESENTATIONS

Pries, A., D.B. Stewart, K. Moore, I. Trefry. *Innovative Collection and Reporting for Marine Mammal Monitoring, Portsmouth Naval Shipyard Drydock 1*. Kittery, Maine. Ports 22 Conference, Honolulu, Hawaii. 2022

Reilly, T., V. King, D. Stewart. Stantec Expands Natural Capital Practice, Building Resilience & Unlocking Value in Ecosystems. *Environmental Business Journal*, 2021.

Stewart, D.B., *Environmental DNA – Real Time Results in the Field to Confirm the Presence/Absence of Target Species*. Gulf 3, International Conference on Managing the Health of the Gulf Ecosystem, Dubai, UAE, November 2019.

Riley, J., D. Stewart, M. Murdoch, R. Hanner, S. Crookes, and M. Thomas. Environmental DNA: Real-Time Results in the Field to Confirm the Presence of Target Species. *Environmental Concerns in Rights-of-Way Management ,12th International Symposium, Utility Arborist Association*. 2019.

Reilly, T., V. King, D. Stewart. Stantec Expands Natural Capital Practice, Building Resilience & Unlocking Value in Ecosystems. *Environmental Business Journal*, 2021.

East Branch of Greenlaw Brook Restoration – The 10 Year Anniversary. *Battelle Fifth International Conference on Remediation of Contaminated Sediments*, 2009.

Wetland and Vernal Pool Identification and Regulation in New England. *Town of North Yarmouth, Maine Public Meeting*, 2007.

Vernal Pool Ecology and Characterization. *Maine Department of Environmental Protection Task Force*, 2007.

Vernal Pool Ecology. *Town of Falmouth, Maine, Public Meeting to Introduce Proposed Town Vernal Pool Regulations*, 2007.

Lortie, J.P., D.S. Hopkins, S. Svirskey Jr., and D.B. Stewart. Lessons learned from five years of restoration and monitoring of 50 acres of wetlands following CERCLA cleanup at the former Loring Air Force Base, Limestone, Maine, 1995-2000. *Quebec 2000: Millennium Wetland Event proceedings*, 2000.

## **EXHIBIT B**



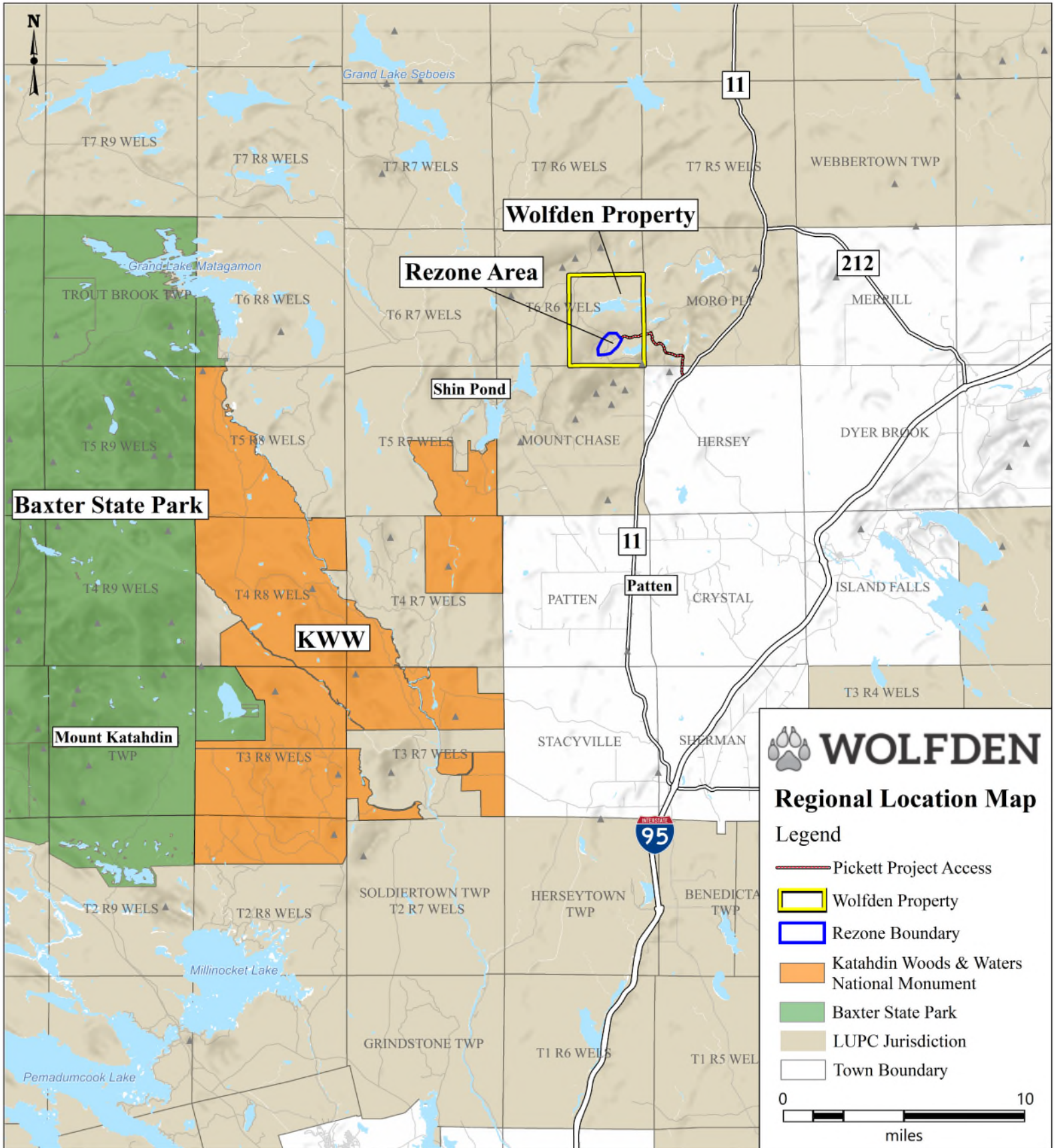

**WOLF DEN**

**Regional Location Map**

**Legend**

- Pickett Project Access
- Wolfden Property
- Rezone Boundary
- Katahdin Woods & Waters National Monument
- Baxter State Park
- LUPC Jurisdiction
- Town Boundary

0 10  
miles

# **EXHIBIT C**



U:\1956019560231703\_data\gis\_cad\gis\MapData\Archeological Testimony Maps Sept2023.aprx Revised: 2023-09-18 By: gcarpentier

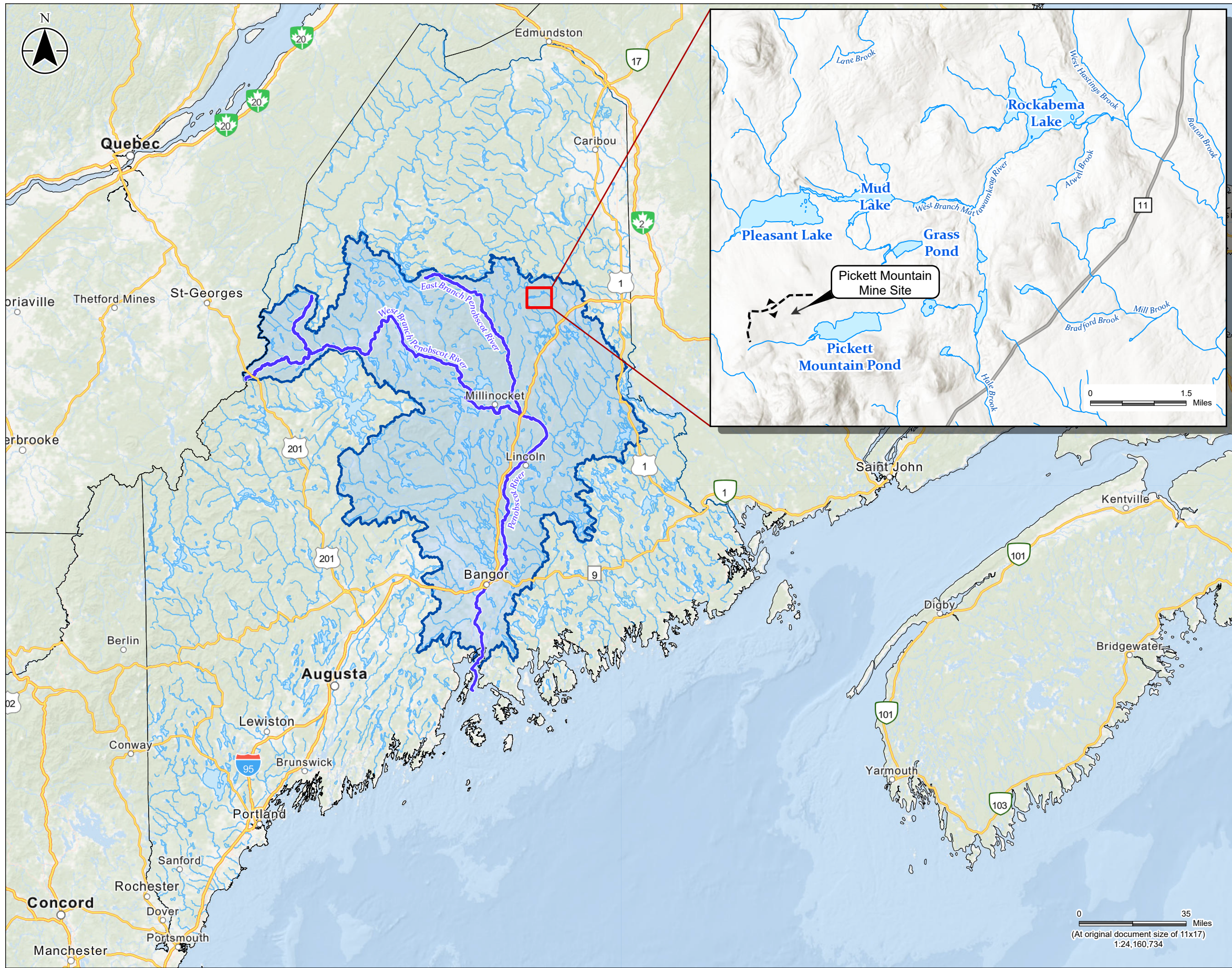

Legend

- Penobscot River
- Penobscot River Watershed
- River/Stream
- Lake/Pond
- Site Drainage Boundary

- Notes**
1. Coordinate System: NAD 1983 UTM Zone 19N
  2. Data Sources: MEGIS, LUPC, USGS, ESRI
  3. Background: ESRI Work Ocean Base Map

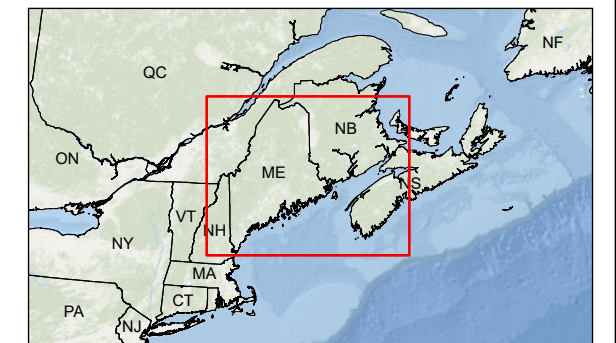

**Project Location**  
T6 R6 WELS, Maine

Prepared by GC on 2023-09-15  
Reviewed by DS on 2023-09-15

**Client/Project**  
Wolfden Resources Corporation  
Pickett Mountain Metallic Mine Project

195602317

Figure No.

**Exhibit 2**

Title

**Penobscot River Watershed**

0 35 Miles  
(At original document size of 11x17)  
1:24,160,734



## **EXHIBIT D**



**From:** Stratton, Robert D <Robert.D.Stratton@maine.gov>  
**Sent:** Monday, September 25, 2023 9:34 AM  
**To:** Stewart, Doug (Topsham)  
**Subject:** RE: Information Request: T6R6, Wolfden Mount Chase LLC, Pickett Mountain Rezoning Proposal

Good morning Doug,

Per your request, MDIFW's Data and Application Management Program has reviewed IWWH #UMO-4024 on Pickett Mountain Pond in T6R6 WELS. Upon reevaluation of the habitat components, this IWWH falls below the criteria to be considered a Moderate or High Valued IWWH. As such, though it will still be regulated as a wetland, it will not be considered an IWWH. Thanks, Bob.

Bob Stratton  
Wildlife Biologist  
Environmental Program Manager  
Maine Department of Inland Fisheries & Wildlife  
353 Water Street; 41 State House Station  
Augusta, Maine 04333-0041  
(207) 287-5659 office; (207) 592-5446 cell  
[mefishwildlife.com](http://mefishwildlife.com)

*Correspondence to and from this office is considered a public record and may be subject to a request under the Maine Freedom of Access Act. Information that you wish to keep confidential should not be included in email correspondence.*



---

**From:** Stewart, Doug (Topsham) <doug.stewart@stantec.com>  
**Sent:** Wednesday, September 20, 2023 4:28 PM  
**To:** Stratton, Robert D <Robert.D.Stratton@maine.gov>  
**Subject:** RE: Information Request: T6R6, Wolfden Mount Chase LLC, Pickett Mountain Rezoning Proposal

**EXTERNAL: This email originated from outside of the State of Maine Mail System. Do not click links or open attachments unless you recognize the sender and know the content is safe.**  
Thanks Bob, I appreciate it. Please send me the results of the metrics evaluated and your overall results once completed.

---

**From:** Stratton, Robert D <[Robert.D.Stratton@maine.gov](mailto:Robert.D.Stratton@maine.gov)>  
**Sent:** Wednesday, September 20, 2023 2:55 PM

**To:** Stewart, Doug (Topsham) <[doug.stewart@stantec.com](mailto:doug.stewart@stantec.com)>  
**Subject:** RE: Information Request: T6R6, Wolfden Mount Chase LLC, Pickett Mountain Rezoning Proposal

Good afternoon Doug,

Field data sheets are not available. The values for the UMO IWWHs were assigned through a GIS process using the resource polygon and mapping criteria at the time (2003). As mapped, it is a 16.4 acre moderate value IWWH. As you may know, the criteria for value are based on physical characteristics, such as size, amount of interspersion, etc. Both moderate and high value IWWHs are regulated as Significant Wildlife Habitats. MDIFW reassesses IWWHs and TWWHs periodically to validate rankings. One of my colleagues is reviewing UMO-4024 and I'll let you know the result as soon as possible. Thanks, Bob.

Bob Stratton  
Wildlife Biologist  
Environmental Program Manager  
Maine Department of Inland Fisheries & Wildlife  
353 Water Street; 41 State House Station  
Augusta, Maine 04333-0041  
(207) 287-5659 office; (207) 592-5446 cell  
[mefishwildlife.com](http://mefishwildlife.com)

*Correspondence to and from this office is considered a public record and may be subject to a request under the Maine Freedom of Access Act. Information that you wish to keep confidential should not be included in email correspondence.*

---

**From:** Stewart, Doug (Topsham) <[doug.stewart@stantec.com](mailto:doug.stewart@stantec.com)>  
**Sent:** Wednesday, September 20, 2023 11:35 AM  
**To:** Stratton, Robert D <[Robert.D.Stratton@maine.gov](mailto:Robert.D.Stratton@maine.gov)>  
**Subject:** FW: Information Request: T6R6, Wolfden Mount Chase LLC, Pickett Mountain Rezoning Proposal

**EXTERNAL: This email originated from outside of the State of Maine Mail System. Do not click links or open attachments unless you recognize the sender and know the content is safe.**

Hi Bob, Looping back on this and let me know if there is someone else at IFW I can contact regarding this information?

---

**From:** Stewart, Doug (Topsham)  
**Sent:** Thursday, September 14, 2023 4:11 PM  
**To:** [Robert.D.Stratton@maine.gov](mailto:Robert.D.Stratton@maine.gov)  
**Subject:** FW: Information Request: T6R6, Wolfden Mount Chase LLC, Pickett Mountain Rezoning Proposal

Hi Bob, Hope you are doing well these days! Following on my phone message today and the subject project. I'm interested in learning more background information on moderately rated #UMO-4024 detailed in the attached letter. Could you please provide the data sheets associated with the surveys for this when you get a chance?

---

**From:** Stratton, Robert D <[Robert.D.Stratton@maine.gov](mailto:Robert.D.Stratton@maine.gov)>  
**Sent:** Thursday, July 28, 2022 7:47 AM  
**To:** Jeremy Ouellette <[jouellette@wolfdenresources.com](mailto:jouellette@wolfdenresources.com)>; Stewart, Doug (Topsham) <[doug.stewart@stantec.com](mailto:doug.stewart@stantec.com)>; Barnes, Brooke <[brooke.barnes@stantec.com](mailto:brooke.barnes@stantec.com)>  
**Cc:** Pries, Alex <[Alex.Pries@stantec.com](mailto:Alex.Pries@stantec.com)>  
**Subject:** FW: Information Request: T6R6, Wolfden Mount Chase LLC, Pickett Mountain Rezoning Proposal

Please see the attached. Thank you, Bob.

Bob Stratton



MDIFW

---

**From:** Stratton, Robert D  
**Sent:** Wednesday, July 27, 2022 3:35 PM  
**To:** Pries, Alex <[Alex.Pries@stantec.com](mailto:Alex.Pries@stantec.com)>  
**Cc:** Carr, Tim <[Tim.Carr@maine.gov](mailto:Tim.Carr@maine.gov)>; Beyer, Stacie R <[Stacie.R.Beyer@maine.gov](mailto:Stacie.R.Beyer@maine.gov)>; Clark, Michael S <[Michael.S.Clark@maine.gov](mailto:Michael.S.Clark@maine.gov)>; Stebbins, Mark N <[Mark.N.Stebbins@maine.gov](mailto:Mark.N.Stebbins@maine.gov)>; Puryear, Kristen <[Kristen.Puryear@maine.gov](mailto:Kristen.Puryear@maine.gov)>; [wende\\_mahaney@fws.gov](mailto:wende_mahaney@fws.gov); Dunham, Kevin <[Kevin.Dunham@maine.gov](mailto:Kevin.Dunham@maine.gov)>; Caron, Mark <[Mark.Caron@maine.gov](mailto:Mark.Caron@maine.gov)>; IFWEnvironmentalreview <[IFWEnvironmentalreview@maine.gov](mailto:IFWEnvironmentalreview@maine.gov)>  
**Subject:** Information Request: T6R6, Wolfden Mount Chase LLC, Pickett Mountain Rezoning Proposal

Good afternoon Alex,

I am writing in response to your request of June 27, 2022 for resource information for the T6R6, Wolfden Mount Chase LLC, Pickett Mountain Rezoning Proposal. I apologize for the delay. Please find MDIFW's review and recommendations attached. If you have any questions or concerns, feel free to contact me. Thank you, Bob.

Bob Stratton  
Wildlife Biologist  
Environmental Program Manager  
Maine Department of Inland Fisheries & Wildlife  
353 Water Street; 41 State House Station  
Augusta, Maine 04333-0041  
(207) 287-5659 office; (207) 592-5446 cell  
[mefishwildlife.com](http://mefishwildlife.com)

*Correspondence to and from this office is considered a public record and may be subject to a request under the Maine Freedom of Access Act. Information that you wish to keep confidential should not be included in email correspondence.*

**Caution:** This email originated from outside of Stantec. Please take extra precaution.

**Attention:** Ce courriel provient de l'extérieur de Stantec. Veuillez prendre des précautions supplémentaires.

**Atención:** Este correo electrónico proviene de fuera de Stantec. Por favor, tome precauciones adicionales.

**Caution:** This email originated from outside of Stantec. Please take extra precaution.

**Attention:** Ce courriel provient de l'extérieur de Stantec. Veuillez prendre des précautions supplémentaires.

**Atención:** Este correo electrónico proviene de fuera de Stantec. Por favor, tome precauciones adicionales.

STATE OF MAINE  
DEPARTMENT OF AGRICULTURE, CONSERVATION & FORESTRY  
LAND USE PLANNING COMMISSION

IN THE MATTER OF	)	Pre-Filed Direct Testimony of
REZONING PETITION ZP 779A	)	Gemma-Jayne Hudgell
WOLFDEN MT. CHASE, LLC	)	on Behalf of Wolfden
	)	Mt. Chase, LLC

On behalf of Wolfden Mt. Chase, LLC (“Wolfden”), Gemma-Jayne Hudgell is submitting this pre-filed direct testimony in support of ZP 779A.

**I. QUALIFICATIONS AND EXPERIENCE**

I am a co-Principal Investigator and Director of the Northeast Archaeology Research Center (NE ARC). NE ARC is a privately-owned consulting firm committed to historic preservation and provides a wide range of high quality and cost-effective cultural resource management consulting services to its clients. Formerly the University of Maine at Farmington Archaeology Research Center (UMF ARC), NE ARC was formed when UMF phased out its consulting archaeology program in 2009. NE ARC is a corporation established in 2008, registered in the State of Maine and certified as a small business. The principals and staff have over 35 years of consulting archaeology experience in New England and have completed several thousand consulting studies in this time. NE ARC serves a diversity of corporate and private concerns including developers, utility companies, telecommunication developers, paper companies and engineering and design firms. NE ARC clients, directly, or as sub-consultants, further include a range of state and federal agencies including the Maine, New Hampshire, and Vermont Departments of Transportation, Maine Bureau of Parks and Recreation, Vermont Agency of Natural Resources, Maine and New Hampshire Army National Guards, U.S. Army Corp of Engineers, Naval Facilities Command, and U.S. Customs and Border Protection. NE

ARC also serves various town municipalities as well as non-profit organizations such as the Maine Coast Heritage Trust and the Vermont River Conservancy.

I, along with my colleagues at NE ARC are highly qualified with experience far exceeding the Secretary of the Interior's minimum professional qualifications for archaeology (Code of Federal Regulations, 36 CFR Part 61; Federal Register 48, 190:44738-44739). Our area of expertise is the Northeast (ME, NH, VT) where we are qualified to perform the full range of cultural resource work. Specifically, for this requested study, my co-principal investigator Robert N. Bartone, M.A. and I are both listed on the Maine Level II Approved List for Prehistoric Archaeology. Following the requirements of the Maine State Historic Preservation Officer (SHPO) (Code of Maine Rules [CMR] Chapter 812: Archaeology Standards), persons meeting the requirements of advanced levels of experience and training in archaeology are qualified to conduct all forms and levels of archaeological work in Maine, and as such are included on the SHPO's Maine Level II Approved List, according to their specialty (Prehistoric or Historic archaeology). NE ARC Principal Investigator Arthur Clausnitzer Jr., Ph.D. is qualified on the Level II Approved List for Historic Archaeology however as noted in the Maine Historic Preservation Commission (MHPC) Project review and further in the Phase 0 Report this Project is not considered sensitive for Historic archaeology.

As well as the SHPO, we have worked directly with the Tribal Historic Preservation Officers (THPO) in Maine, New Hampshire and Vermont. For example, in Maine, NE ARC worked with the Penobscot THPO for the Old Town Municipal Airport Project and for the Katahdin Woods and Waters National Monument (KWWNM) at Lunkoos Camps, and with the Passamaquoddy THPO on the Maine Coast Heritage Trust Treat Island Preserve and the Meddybemps Eastern Surplus Company Superfund Site. NE ARC additionally consults with the

THPO of the Penobscot Indian Nation and Aroostook Band of Micmacs on behalf of the New Hampshire National Guard, and in Vermont, has consulted with the THPO of the Stockbridge-Munsee Band of Mohican Indians and representatives of the Abenaki Nation of Missisquoi and the Elnu Abenaki Tribe on multiple projects.

Robert N. Bartone, M.A. and I were both Principal Investigators on the work associated with the Pickett Mountain Project. As defined in 94-089 CMR Chapter 812, a Principal Investigator means “the person(s) directing an [archaeological] project and responsible for its conduct.” My curriculum vitae is attached as Exhibit A.

## **II. INVOLVEMENT WITH THE PICKETT MOUNTAIN PROJECT**

NE ARC was hired by Wolfden to conduct an archaeological Phase 0 assessment of the Pickett Mountain Project (the “Project”). The purpose of the assessment was to identify locations in the Project area that may be sensitive for the presence of Native American or historic Euroamerican archeological sites. The Phase 0 assessment included background research, archaeological sensitive modeling, field inspection, and a walkover survey consistent with requirements determined by the MHPC as per 94-089 CMR Chapter 812.

This testimony summarizes NE ARC’s archaeological assessment, including the identification of archaeologically sensitive areas (ASAs) within Project area, and discusses the methodology and process associated with identifying and managing ASAs. Our full report is included in the application and is attached for reference hereto as Exhibit B.

## **III. METHODOLOGY**

As part of Wolfden’s LUPC 2020 petition the original 295-acre Project parcel was reviewed by the MHPC and was determined to exhibit moderate archaeological sensitivity for Native American archaeological sites based on the Project location within the area of possible

Ordovician or Silurian chert toolstone outcrops, as well as proximity to a previously identified Native American site located in the Pickett Mountain Pond valley. Based on information from the MHPC, there is a low probability of post-contact Euroamerican archaeological sites being present, mostly being lumbering camps. In general, this description of sensitivity still applies to the updated rezoning area given that there is considerable overlap.

The NE ARC conducted a Phase 0 archaeological assessment to specifically identify all areas that are sensitive for the presence of Native American or historic Euroamerican archaeological sites both within the mine Project area and also at selected locations along the access roads that may be subject to improvement as needed, or to determine that archaeological sites of potential significance are not likely to be present. Significant archaeological sites are those that meet eligibility criteria for listing on the National Register of Historic Places (NRHP). A Phase 0 assessment includes a desk review (archival research, sensitivity modeling, and photograph and map review) as well as a field inspection to ground-truth the results of the desk review and generally results in the identification of specific areas of archaeological sensitivity, or the determination that no such areas exist within a given project area.

If areas of sensitivity are identified, a Phase I reconnaissance survey is recommended. This involves archaeological testing in specific areas of archaeological sensitivity to determine if archaeological sites of potential significance (NRHP-eligible) are present within the area of potential effect (APE) of a given project, or to establish the sites are unlikely to be present. Testing may include subsurface excavation or, if ground conditions permit (such as a plowed field), systematic surface survey.

If an archaeological site(s) is identified, Phase II Intensive Survey is employed to determine site limits, site content, and site condition. This work determines the significance of



the cultural deposits in terms of NRHP eligibility as well as provide information to determine if site avoidance and protection are necessary, or if not possible, the need for data recovery excavations to mitigate adverse impacts to significant archaeological resources. Phase II survey also provides information necessary for both short and long-term management of identified archaeological resources as appropriate.

As per 94-089 CMR Chapter 812, the Maine State Historic Preservation Officer Kirk F. Mohny and his staff must judge the results of each phase of an archaeological study satisfactory. All archaeological work should be conducted in accordance with the MHPC 1992 Contract Archaeology Guidelines.

#### **IV. PROJECT AREA**

The Project is located on the eastern slopes of an unnamed hill that contains a number of lower hills and knolls. The area is located in the Mattawamkeag River watershed, a sub watershed of the Penobscot River Drainage Basin. The Penobscot River basin is approximately 8,610 square miles and covers between a quarter and third of the state. The Mattawamkeag River forms approximately 31 linear miles southeast of the Project and then flows 50 river miles southwest to join the Penobscot River.

The northern portion of the Project has northerly facing slopes and drains northward to Pleasant Lake/Mud Lake and eventually to the West Branch of the Mattawamkeag River. The southern portion of the Project facing south or southeast and drains southwards to Pickett Mountain Pond, which drains east then northwards, also into Mud Lake and the West Branch of the Mattawamkeag River. Figure 5 (on page 24) of the report attached as Exhibit B shows the major drainage basins in the State.

Our evaluation included the original proposed rezone area as well as the revised rezone area that is the subject of the current application (including the 400-foot buffer in which no construction activities or disturbance will occur), as well as selected locations along access roads that may be subject to improvements as needed or to determine that archeological significant sites of potential significance are not likely present. In addition to roads within the (original and revised) rezone area, access roads considered in the study included approximately 0.8 miles (1.3 km) of a small, unnamed logging road from the junction of Pleasant Lake Road south and westwards into the rezone area. Other roads accessing the rezone area from Route 11 are more substantial logging roads and were not specifically assessed.

## **V. FINDINGS AND NEXT STEPS**

Generally, there is not a high density of known Native American sites in the vicinity of the Project. The general paucity of recorded sites in this part of Maine, however, reflects a lack of research rather than the absence of Native American presence and settlements within the region. For example, it is not uncommon to find archeologically sensitive areas across the landscape when investigations are conducted. NE ARC has recently completed three projects in the local area, including one directly for the Katahdin Woods and Waters National Monument (KWWNM) at Lunkoos Camps, plus two nearby trail developments. Archeological sites were identified at all three projects, including six sites. For each project, the extent of NRHP-eligible archaeological deposits at each site were defined with respect to the extent of project effects, allowing for plans for site avoidance to be established in consultation with the client, SHPO and THPO in each case.

Background review and predictive modeling indicated that the Project area in general is sensitive for the presence of Native American habitation sites based on geological toolstone

resources, proximity to Pickett Mountain Pond and its wetlands, and the presence of a known archaeological site within 400 meters of the southern boundary of the proposed rezoning area. NE ARC's Phase 0 assessment more specifically identified areas of potential archaeological sensitivity, or archeologically sensitive areas (ASAs). In total, NE ARC identified six ASAs. ASAs 1-2, and 6 are inside the proposed rezone area and were identified as potentially archaeologically sensitive based on outcrops of materials in those locations that may be suitable for use as toolstone. *See* Figure 3 (on page 22) of our report, attached as Exhibit B. ASA 3 and 4 were identified as potentially sensitive for similar reasons but are located entirely or almost entirely outside of the proposed rezone area (ASA 3 extends into the 400-foot buffer included within the rezone area). ASA 5 was identified as potentially sensitive based on the presence of a till bench terrace, which may have been used as an area for habitation in the past given that this is the same broad landform as the nearby, previously identified archaeological site. *See* Figure 3 (page 22). ASA 5 is located almost entirely outside of the proposed rezone area but, like ASA 3, extends partially into the 400-foot rezone buffer. *See* Figure 3 (page 22).

Archeological sites are considered unlikely to be present in all other portions of the Project area outside of the defined ASAs. Nonetheless, we understand that the Project will implement a plan during construction regarding potential unanticipated discovery of artifacts. The typical protocol for coordination in the event of inadvertent discovery is as follows:

In the event of an inadvertent discovery of possible cultural materials, including Native American artifacts and also including human remains, all work will stop immediately in the vicinity of the find. A 30-meter buffer will be placed around the discovery with work being able to proceed outside of this buffered area unless additional cultural materials are encountered.

- The area will be secured and protected (physically marked via snow fencing or equivalent temporary measure).
- The project manager/site supervisor will be notified. The project manager/site supervisor will notify a professional archaeologist (archaeologists approved by the MHPC can be found at <https://www.maine.gov/mhpc/programs/survey/approved-consultants>). No work may resume until consultation with a professional archaeologist has occurred and the archaeologist is able to assess the discovery.
- If potential human remains are encountered, the Maine State Police or Washington County Sheriff will first be notified, along with the THPO and SHPO.
- If human remains are encountered, do not disturb them in any way. If there is obvious evidence of recent death (such as clothing, other perishable effects), call local police or Sheriff as listed above. If remains are bones, make contact as in the above list. Do not speak with the media. Secure the location. Do not take photos. The location will be secured and work will not resume in the area of discovery until all parties involved agree upon a course of action.
- If a professional archaeologist is needed to assess the discovery they will consult with SHPO and appropriate THPO/Tribal Governments to determine an appropriate course of action.
- Archaeological excavations may be required. This is handled on a case by case basis by the professional archaeologist and client, in consultation with SHPO and appropriate Tribes.
- Some areas may be specified for close monitoring or as “no-work-zones” within the larger project area.
- Construction can only proceed after consultation has been concluded.

Because all the Project facilities and earth disturbing activities will be located outside of the ASAs, no impacts to archeological resources are anticipated. Nonetheless, NE ARC recommends, and we understand that Wolfden will conduct a Phase I survey for each of the ASAs entirely within the rezone area (ASAs 1, 2 and 6) as well as those portions of ASAs 3 and 5 that fall within the rezone area. A Phase I survey will determine whether archeological sites of significance are present. As part of the Phase I survey and consistent with our practice on investigating other sites in the region, if no archaeological sites are identified, a recommendation

will be made to MHPC that potentially significant archaeological sites are unlikely to be present and that no further archaeological work is warranted. Alternatively, should potentially significant NRHP-eligible archaeological site(s) be identified, Phase II survey will be recommended in order to determine site limits, site content, site condition, and the significance of the cultural deposits in terms of NRHP eligibility. As previously noted, Phase II survey will provide information to determine if site avoidance and protection are necessary, or if not possible, the need for data recovery excavations to mitigate adverse impacts to significant archaeological resources. Phase II survey also provides information necessary for both short and long-term management of identified archaeological resources as appropriate.

For each Phase, we will consult with the SHPO and THPO. Specifically, as per 94-089 CMR Chapter 812, the Maine State Historic Preservation Officer Kirk F. Mohny and his staff must judge the results of each phase of an archaeological study satisfactory. All archaeological work will be conducted in accordance with the MHPC 1992 Contract Archaeology Guidelines.

Finally, no Euroamerican resources were observed, and the Project area is not sensitive for archaeological resources associated with 19th century logging and lumbering activities, and historic recreational hunting, fishing, and camping activities, as has been confirmed by MHPC.

Dated: 9/14/2023

Gemma-Jayne Hudgell  
Gemma-Jayne Hudgell

STATE OF MAINE  
County of Oxford

Date: 9/14/2023

Personally appeared before me the above named Gemma-Jayne Hudgell, who, being duly sworn, did testify that the foregoing testimony was true and correct to the best of her knowledge and belief.

Before me,

Janet E. Brennick

Notary Public

My commission expires: \_\_\_\_\_

**Janet E. Brennick**  
Notary Public, State of Maine  
My Commission Expires 09/23/2026

# **EXHIBIT A**

## **Gemma-Jayne Hudgell**

Northeast Archaeology Research Center, Inc.  
382 Fairbanks Road, Farmington, Maine 04938  
207-860-4032 / hudgell@nearchaeology.com

### **Education:**

- 2006 Ph.D. in Archaeology, University of Liverpool, UK
- 2000 Masters of Arts in Archaeology, University of Liverpool, UK
- 1998 Bachelors of Arts in Archaeology, University of Durham, UK

### **Professional Experience:**

- 2018-Present* Vice President/Assistant Director for Archaeology, Northeast Archaeology Research Center, Inc.
- 2009-2018* Project Director/Prehistoric Archaeologist, Northeast Archaeology Research Center, Inc.
- 2007-2008* Project Director, University of Maine at Farmington (UMF) Archaeology Research Center (ARC)
- 2008* Substitute Lecturer, Department of Social Sciences and Business, UMF
- 2006* Volunteer Field/Laboratory Technician and Editor, UMF ARC
- 2003-2005* Lecturer, Continuing Education program, University of Liverpool
- 2001-2005* Teaching Assistant, School of Archaeology, Classics and Egyptology (SACOS), University of Liverpool
- 2005* Project Participant, ACACIA (Ancient Culture and Cognition in Africa) Project, Sibudu Cave, KwaZulu-Natal, South Africa (University of the Witwatersrand, Johannesburg)
- 2003- 2004* Lecturer and Tutor, SACOS, University of Liverpool
- 1999-2001* Graduate Assistant and Surface Survey Supervisor, Makapansgat Middle Pleistocene Research Project, Makapansgat, Limpopo Province, South Africa
- 2000* University of Liverpool Archaeological Field School, Carden Park, Cheshire, England
- 1995-1997* University of Durham Archaeological Field School, Northumberland, England

- Dr. Hudgell has a Ph.D. in archaeology from the University of Liverpool and has extensive experience in prehistoric and historic archaeology in the UK, southern Africa, and the United States, including both pre-contact Native American and post-contact historical archaeology in the Northeast.
- Responsibilities as Assistant Director for Archaeology at the Northeast Archaeology Research Center, Inc. include oversight and management of all aspects of the NE ARC, including implementation of specific consulting archaeology projects with a focus on pre-Contact Native American cultural resources. This includes development of budgets, scopes-of-work, research proposals and research designs; archaeological assessment; the direction of archaeological fieldwork; report writing, preparation and final editing; and artifact analysis and site interpretation with a focus on lithic cultural material. Additional responsibilities include archaeological monitoring, public education, and outreach.
- Dr. Hudgell is highly qualified with experience far exceeding the Secretary of the Interior's minimum professional qualifications for archaeology (Code of Federal Regulations, 36 CFR Part 61; Federal Register 48, 190:44738-44739). Dr. Hudgell is qualified to perform all levels of cultural resource work in the Northeast and has 12 years of experience in all phases of consulting archaeology. She currently serves as one of the Society for American Archaeology Public Education Committee State Archaeology Coordinators for Maine. She is 40-hour hazwoper trained.

### **SELECT PROJECTS, MAINE:**

**2016-present:** *Consultant Archaeologist/Field Director, Cape Porpoise Archaeological Alliance, Cape Porpoise, Kennebunkport, Maine.* The Alliance forms the initiation of an ongoing and potentially long-standing project



concerned with the investigation and recordation of coastal archaeological resources in the vicinity of Kennebunkport, involving the Kennebunkport Conservation Trust, the Brickstore Museum, and the Wells National Estuarine Research Reserve, with support from the Maine Historic Preservation Commission. Recent work include Phase I Survey of Stage and Redin islands and attendant identification and/or study and recordation of a series of pre-and post-contact Native American and Euroamerican sites, including identification, excavation and preservation of Maine's oldest and only pre-contact dugout canoe.

**2017:** *Project Director/Prehistoric Archaeologist, Archaeological Survey of the York River Headwaters: A Community Approach for Identification and Management.* The U.S. Congress passed the York River Wild and Scenic Study Act in 2014 which authorized the York River Study to develop a management plan for the York River Watershed and to evaluate the eligibility and suitability of the Watershed as a candidate for the Wild and Scenic River designation. The archaeological portion of the study determined the presence of significant archaeological cultural resources in the 2050-acre study area.

**2016-2017:** *Project Director, Archaeological Phase I Survey of the Maine Coast Heritage Trust Treat Island Preserve: A Community Approach for Identification and Preservation.* The MCHT acquired the 73-acre island in 2009 and manages it as a preserve allowing public visitation. The project initiated the process of identifying and documenting cultural resources on the island including archaeological sites and historic features possibly present, and involved trained archaeological technicians from the NE ARC, the University of Maine at Orono, and the Passamaquoddy Tribe, and considerable volunteer assistance.

**2014:** *Project Director, Archaeological Phase III Data Recovery and Public Volunteer Program at the Lamontagne Site (23.38 ME), Auburn, Androscoggin County.* This Auburn Business Development Corp. and Maine Historic Preservation Commission-associated project included phase III data recovery of a Paleoindian site prior to completion of the Auburn industrial park, and dissemination of the results of the work to the public via presentations and reports.

**2012-present:** *Project Director, Archaeological Assessments of Proposed Cell Tower Locations.* To date Dr. Hudgell has completed more than 40 desk reviews/archaeological assessments on behalf of Black Diamond Consultants, Inc. and their clients US Cellular and Wireless Partners II, LLC as part of the Section 106 regulatory process.

**2014:** *Project Director, Archaeological Phase I Survey, Upper Magurrewock Dam Project, Moosehorn National Wildlife Refuge, Calais, Washington County, for the U.S. Fish and Wildlife Service through a contract with Panamerican Consultants, Inc.* Dr. Hudgell supervised field survey of proposed modifications to a spillway and staging area, resulting in the identification of a newly identified historic Euroamerican site, ME 071-018, the remains of a former mid-19<sup>th</sup> century to early 20<sup>th</sup>-century ice house.

**2014:** *Project Director, Post-Review Impacts to Historic Properties through Controlled Archaeological Surface Collection of the Norway Bluff Quarry Site, 155.19/94 ME, at the U.S. CBP Radio Communications Tower Facility Access Trail, Norway Bluff, Township Range T9 R9, Piscataquis County, for U.S. CBP through a contract with Motorola Solutions, Inc.* Dr. Hudgell supervised fieldwork, interpreted data and produced the project report, concerning an area impacted by trail improvements along the ridgeline of Norway Bluff, part of the Munsungan chert quarry source. Thousands of specimens were recorded and analyzed, and this represents one of the most in-depth studies of a quarry site undertaken in Maine to date.

**2009-2012:** *Project Director, Archaeological Phase I Survey, Phase II Testing, and Phase III Mitigation within the Bridgewater U.S. Customs and Border Protection Land Port of Entry Modernization Project Area, Bridgewater, Aroostook County, Maine.* Dr. Hudgell acted as writer and primary editor for the combined archaeological reports, also providing extensive technical contributions in the form of prehistoric artifact

analysis and site interpretation. The investigations included the Native American Boundary Line Road Site, 159.1 ME, and the Historic Period Boundary Line Mill Hamlet, ME 055-001.

**2009-2012:** *Project Director, Archaeological Phase I Survey, Phase II Testing, and Phase III Mitigation within the Forest City U.S. Customs and Border Protection Land Port of Entry Modernization Project Area, Forest City, Washington County, Maine.* Dr. Hudgell was primary author and editor for the archaeological reports on Paleoindian site 126.31 ME, after conducting prehistoric artifact analysis and site interpretation. The investigations also included the Historic Period F. Shaw and Brothers Tannery site, ME 552-001. Dissemination of information on the Paleoindian site included both a public and an academic focus, including public meetings, educational brochures, journal articles and presentations at the Society for American Archaeology and the Eastern States Archaeological Federation meetings.

#### **NEW HAMPSHIRE:**

**2017-present:** *Project Director/co-Principal Investigator, Archaeological Phase IA Sensitivity Assessments, Phase IB Intensive Archaeological Investigations, and Phase II Determination of Eligibility: various Eversource projects.* NE ARC are subcontracted by Vanasse Hangen Brustlin, Inc (VHB) to undertake cultural resource management work for various Eversource powerline and infrastructure projects throughout New Hampshire. Dr. Hudgell acts as the co-Principal Investigator and her responsibilities also include report editing, pre-contact artifact analysis, and site interpretation.

**2014-present:** *Project Director/co-Principal Investigator, New Hampshire Army National Guard, Archaeological Phase IA Sensitivity Assessments, Phase IB Intensive Archaeological Investigations, and Phase II Determination of Eligibility: various projects.* Dr. Hudgell conducted artifact analysis and background research and acted as one of the primary editors for reports for various NH ARNG properties under NE ARC's general contract.

**2012-present:** *Project Director/co-Principal Investigator, New Hampshire Department of Transportation, Archaeological Phase IA Sensitivity Assessments, Phase IB Intensive Archaeological Investigations, Phase II Determination of Eligibility, and Phase III Data Recovery and Mitigation: various projects.* Dr. Hudgell acts as the co-Principal Investigator for a number of NH DOT projects under the current Statewide On-Call Archaeological Services Agreement. Her responsibilities also include field inspection, pre-contact artifact analysis, site interpretation, and public dissemination of information.

#### **VERMONT:**

**2018-present:** *Project Director/Co-Principal Investigator, Vermont Agency of Transportation, Archaeological Resource Assessments, Phase I Survey, Phase II Determination of Eligibility, and Phase III Data Recovery and Mitigation: various projects.* Dr. Hudgell acts as a Project Director and co-Principal Investigator for a number of VTrans projects under the current Statewide Archaeological Consultant General Contract. Her responsibilities also include field inspection, pre-contact artifact analysis, site interpretation, and public dissemination of information.

**2016-present:** *Project Director, Archaeological Resource Assessments for Hazard Mitigation Grant Program Projects: Vermont Department of Public Safety and various Vermont towns.* Dr. Hudgell conducted a number of archaeological resource assessments of proposed projects throughout Vermont, including background research, archaeological sensitivity modelling, and field inspections. Each of the projects required Section 106 review given Federal Emergency Management Agency funding following flood damage sustained in 2011 as a result of Tropical Storm Irene.

**2014-present:** *Project Director, Green Mountain Power FERC Projects: Lamoille River Hydroelectric Project, FERC No. 2205; Otter Creek Hydroelectric Project, FERC No. 2558; Vergennes Hydroelectric Project, FERC No.*

2674; *Weybridge Hydroelectric Project, FERC No. 2731*. Dr. Hudgell is Project Director of a series of current archaeological projects undertaken on behalf of Green Mountain Power (GMP) as part of their dam relicensing requirements. Responsibilities include project management; archaeological resource assessment; field supervision; and report production for phase I, II and III work.

**2014-present:** *Project Director, Archaeological Trail Assessments as required by the Vermont Agency of Natural Resources*. Dr. Hudgell has conducted numerous archaeological assessments for the Section 106 requirements for trail construction in Vermont. Clients requiring these services have included the Vermont Department of Forests, Parks and Recreation; Vermont Fish and Wildlife Department; various towns (including Plainfield, Fairfax, and Johnson); and various State Parks and Wildlife Management Areas (including Bomoseen, Boyer, Ricker, and Wenlock).

**2013-2014:** *Project Director, Archaeological Phase III Data Recovery and Mitigation of Native American site VT-FR-30 within the Streambank Stabilization Project, Highgate, Franklin County, Vermont*. The NE ARC, through a contract with Panamerican Consultants, Inc., conducted archaeological phase III data recovery excavations in the area of NR-eligible site VT-FR-30 located within the Missisquoi National Wildlife Refuge. This work was undertaken as part of the mitigation of adverse effects of a Streambank Stabilization Project conducted by the U.S. Fish and Wildlife Service (FWS) within the area of the site.

#### **SELECT MAINE REPORTS**

Beale, David, Robert Bartone, and Gemma-Jayne Hudgell

2021 *Archaeological Phase I Survey of the Proposed Winslow Pump Station Upgrades Project, MHPC #0253-20 Winslow, Kennebec County, Maine*. Prepared for Wright-Pierce and the Town of Winslow by Northeast Archaeology Research Center, Inc., Farmington, ME.

Beale, David, Gemma-Jayne Hudgell, Robert N. Bartone, and Ellen R. Cowie

2016 *Archaeological Phase I Survey of the Maine Army National Guard Woodville Training Site, T2R9 NWP, Penobscot County, Maine*. Submitted to the Maine Army National Guard by Northeast Archaeology Research Center, Inc., Farmington, ME.

2018 *Archaeological Phase I Survey and Phase II Testing of the Katahdin River Trails Project, Penobscot County, Maine*. Prepared for CES by Northeast Archaeology Research Center, Inc., Farmington, ME.

Beale, David W., Robert N. Bartone, and Gemma-Jayne Hudgell

2019b *Archaeological Phase I Survey and Phase II Testing of the Proposed Seboeis Trail Project, (MHPC #1439-16), T5R7 and T6R7 WELS, Penobscot County, Maine*. Prepared for CES, Inc. and the Butler Group by the Northeast Archaeology Research Center, Inc., Farmington, ME.

Brigham, Michael, Gemma-Jayne Hudgell, Jessica Stuart, Robert Bartone, and Ellen Cowie

2010 *Archaeological Phase II Testing of Site 126.31 ME, within the Forest City Land Port Of Entry Modernization Project Area for U.S. Customs and Border Protection, Washington County, Maine*. Northeast Archaeology Research Center, Inc.

Crones, C. Randall, Gemma-Jayne Hudgell, Stephen R. Scharoun, Robert N. Bartone, and Ellen R. Cowie

2007 *Archaeological Phase I Survey of the Plum Creek Development on Long Pond, Long Pond Township, Somerset County, Maine*. University of Maine at Farmington Archaeology Research Center. Prepared for Plum Creek Land Company and Plum Creek Maine Timberlands, LLC.

Grindle, Jacob E., Gemma-Jayne Hudgell, Rick Morris, Stephen R. Scharoun, Robert N. Bartone, and Ellen R. Cowie

2009 Phase I Cultural Resources Survey for the Hamlin Land Point of Entry Modernization Project for the U.S. Customs and Border Protection, Hamlin, Aroostook County, Maine. Northeast Archaeology Research Center.

Grindle, Jacob E., Stephen R. Scharoun, Michael Brigham, Gemma-Jayne Hudgell, Robert N. Bartone, and Ellen R. Cowie

2009 Phase I Cultural Resources Survey for the Bridgewater Land Point of Entry Modernization Project for the U.S. Customs and Border Protection, Bridgewater, Aroostook County, Maine. Northeast Archaeology Research Center, Inc.

Hudgell, Gemma-Jayne, and Robert Bartone

2020a *Archaeological Phase I Survey of the Proposed Rumford Solar, LLC Rumford Solar Project, Rumford, Oxford County, Maine (MHPC #1778-19)*. Prepared for Sevee and Maher Engineers, Inc. and Rumford Solar, LLC by Northeast Archaeology Research Center, Inc., Farmington, ME.

2020b *Archaeological Phase I Survey of the Proposed Borrego Oxford Solar Project, 278 Main Street, Oxford, Oxford County, Maine (MHPC #0098-20)*. Prepared for Borrego Solar Systems, Inc. by Northeast Archaeology Research Center, Inc., Farmington, ME.

2021 *Archaeological Phase I Survey of the Proposed Deer Park Development Project, Milford, Penobscot County, Maine (MHPC #1673-20)*. Prepared for Haley Ward, Inc. by Northeast Archaeology Research Center, Inc., Farmington, ME.

Hudgell, Gemma-Jayne, Robert Bartone, and Ellen Cowie

2014 *Post-Review Impacts to Historic Properties through Controlled Archaeological Surface Collection of the Norway Bluff Quarry Site, 155.19/94 ME, at the U.S. CBP Radio Communications Tower facility Access Trail, Norway Bluff, Piscataquis County, Maine: Research Design*. Prepared for Patriot Towers, Inc. by Northeast Archaeology Research Center, Inc., Farmington, Maine.

2016 *The View From Norway Bluff: A Chert Quarry and Workshop Site in Northern Maine. Post-Review Impacts to Historic Properties through Controlled Archaeological Surface Collection of the Norway Bluff Quarry Site, 155.19/94 ME, at the U.S. CBP Radio Communications Tower Facility Access Trail, Norway Bluff, Piscataquis County, Maine*. Prepared for U.S. Customs and Border Protection by Northeast Archaeology Research Center, Inc., Farmington, Maine.

Hudgell, Gemma-Jayne, Robert Bartone, and Bruce G. Harvey

2021 *Cultural Resources Survey Report for the Proposed Houlton Border Patrol Station Project Houlton, Aroostook County, Maine*. Prepared for Gulf South Research Corporation by Northeast Archaeology Research Center, Inc. and Harvey Research and Consulting, Farmington, ME.

Hudgell, Gemma-Jayne, and Robert N. Bartone

2016 *Archaeological Phase I Survey of the Proposed Long Logan Educational Campus Portion of the Katahdin River Trails Project, T2 R7 WELS, Penobscot County, Maine, End of Field Letter Report*. Prepared for CES, Inc. by the Northeast Archaeology Research Center, Inc., Farmington, ME.

2020a *Archaeological Phase I Survey of the Proposed Maine Rivers Outlet Dam, MHPC # 1570-19, Vassalboro, Kennebec County, Maine*. Prepared for Maine Rivers by the Northeast Archaeology Research Center, Inc., Farmington, ME.

2020b *Archaeological Phase 0 Assessment for the Proposed Pickett Mountain Mine Project, T6R6 WELS, Penobscot County, Maine*. Prepared for Wolfden Resources Corporation by the Northeast Archaeology Research Center, Inc., Farmington, Maine.

2023 *Archaeological Phase I Survey of the Hackett Mills Hydroelectric Project (FERC No. 6398), Minot and Poland, Androscoggin County, Maine.* Prepared for Hackett Mills Hydro Associates by the Northeast Archaeology Research Center, Inc., Farmington, ME.

Hudgell, Gemma-Jayne, Robert N. Bartone, and Ellen R. Cowie  
2017 *Archaeological Phase III Data Recovery and Public Volunteer Program at the Lamontagne Paleoindian Site (23.38 ME), Auburn, Androscoggin County, Maine.* Prepared for the Auburn Business Development Corporation by the Northeast Archaeology Research Center, Inc., Farmington, Maine.

Hudgell, Gemma-Jayne, Michael S. Brigham, Robert N. Bartone, and Ellen R. Cowie  
2011 *Archaeological Phase III Data Recovery at Locus 1 of Paleoindian Site 126.31 ME within the Forest City Land Port of Entry Modernization Project Area, for U.S. Customs and Border Protection, Washington County, Maine.* Prepared for U.S. Customs and Border Protection by Northeast Archaeology Research Center, Inc.

Hudgell, Gemma-Jayne, and Ellen Cowie  
2013 *Archaeological Assessment of the Trail Improvements to the U.S. CBP Radio Communications Tower, Norway Bluff, Piscataquis County, Maine.* Northeast Archaeology Research Center.

Hudgell, Gemma-Jayne, Ellen R. Cowie, and Robert N. Bartone  
2014 *Archaeological Phase I Survey Upper Magurrewock Dam Project, Moosehorn National Wildlife Refuge, Calais, Washington County, Maine.* Prepared for U.S. Fish and Wildlife Service by Northeast Archaeology Research Center, Inc. and Panamerican Consultants, Inc., Farmington, Maine.

Hudgell, Gemma-Jayne, Rosemary A. Cyr, Robert N. Bartone, and Ellen R. Cowie  
2017 *Archaeological Phase I Survey of the Maine Coast Heritage Trust Treat Island Preserve: A Community Approach for Identification and Preservation.* Submitted to the Maine Coast Heritage Trust by the Northeast Archaeology Research Center, Farmington, Maine.

Hudgell, Gemma-Jayne, Sarah E. Loftus, and Robert N. Bartone  
2019 *Archaeological Phase I Survey of the Maine Army National Guard Woodville Training Site, T2R9 NWP, Penobscot County, Maine.* Submitted to the Maine Army National Guard by Northeast Archaeology Research Center, Inc., Farmington, ME.

Hudgell, Gemma-Jayne, Stephen Scharoun, Robert Bartone, and Cowie, Ellen R.  
2012 *Archaeological Phase I Survey of the Maine Department of Transportation Bridgewater Bridge Replacement Project (BR#374=34), and Phase II Testing at Newly Identified Loci of Native American Site 159.1 ME and Historic Euroamerican Site ME 055-001, Bridgewater, Aroostook County, Maine.*

Hudgell, Gemma-Jayne, Stephen Scharoun, Robert N. Bartone, and Ellen R. Cowie  
2017 *Archaeological Survey of the York River Headwaters: A Community Approach for Identification and Management.* Prepared for the York River Study Committee by the Northeast Archaeology Research Center, Inc., Farmington, Maine.

Hudgell, Gemma-Jayne, Stephen R. Scharoun, and Ellen R. Cowie  
2010 *Archaeological Phase III Treatment Plan of the Boundary Line Mill Hamlet Historic District, ME 055-001, in the Proposed Customs and Border Protection Land Port of Entry, Bridgewater, Aroostook County, Maine.* Submitted to O'Leary Burke, Civil Associates by the Northeast Archaeology Research Center, Inc.

Hudgell, Gemma-Jayne, Stephen R. Scharoun, Rosemary A. Cyr, Jessica M. Stuart, Robert N. Bartone, and Ellen R. Cowie

2010 Phase I Cultural Resources Survey for the Forest City Land Port of Entry Modernization Project Area for U.S. Customs and Border Protection, Washington County, Maine. Prepared by Northeast Archaeology Research Center, Inc. through a contract with Parsons.

Hudgell, Gemma-Jayne, Sara H. Voorhis, Robert N. Bartone, and Ellen R. Cowie

2017 *Archaeological Phase I Survey of the Cutler B135 Septic System Project Naval Support Activity Cutler, Cutler, Washington County, Maine.* Prepared for CCI Construction Services, LLC and Naval Facilities Engineering Command Mid-Atlantic by Northeast Archaeology Research Center, Inc., Farmington, Maine.

Loftus, Sarah, Robert Bartone, and Gemma-Jayne Hudgell

2021a *Archaeological Phase I Survey of the Proposed Salmons Quarry Operations Project, Bowden Point Road, Prospect, Waldo County, Maine (MHPC # 0177-21).* Prepared for Haley Ward, Inc. and Salmons, Inc. by Northeast Archaeology Research Center, Inc., Farmington, ME.

2021b *Archaeological Phase I Survey of the Proposed 19-55 Popham Waterfront Improvements Project (MHPC #0964-19A) Fort Popham, Phippsburg, Sagadahoc County, Maine.* Prepared for Baker Design Consultants by Northeast Archaeology Research Center, Inc., Farmington, ME.

Loftus, Sarah E., Gemma-Jayne Hudgell, and Robert N. Bartone

2019a *Archaeological Phase I Survey of the Green Mountain Power Rollinsford Hydroelectric Project (FERC No. P-3777), Berwick and South Berwick, York County, Maine.* Prepared for Gomez and Sullivan Engineers, DPC by the Northeast Archaeology Research Center, Inc., Farmington, ME.

McPheters, Hutch M., Gemma-Jayne Hudgell, and Robert N. Bartone

2018 *Archaeological Phase 0 Assessment of the Proposed Seboeis Trail Project, T5R7 and T6R7 WELS, Penobscot County, Maine.* Prepared for CES, Inc. by the Northeast Archaeology Research Center, Inc., Farmington, ME.

Scharoun, Stephen R., Gemma-Jayne Hudgell, and Robert N. Bartone

2018a *Archaeological Phase I Survey of the Proposed East Side Combined Sewer Outflow Storage Tank Project, MHPC # 0042-18 Augusta, Kennebec County, Maine.* Prepared for the Greater Augusta Water District by Northeast Archaeology Research Center, Inc., Farmington, Maine.

2018b *Archaeological Phase I Survey and Phase II Evaluation at Ladd Dam, North Vassalboro, Kennebec County, Maine.* Prepared for Maine Rivers by the Northeast Archaeology Research Center, Inc., Farmington, ME.

Scharoun, Stephen R., Gemma-Jayne Hudgell, Robert N. Bartone, and Ellen R. Cowie

2009 *Archaeological Review of the Proposed Van Buren LPOE Van Buren, Aroostook County, Maine.* Submitted to Panamerican Consultants, Inc. by Northeast Archaeology Research Center.

Scharoun, Stephen R., Gemma-Jayne Hudgell, Jessica Stuart, Rosemary A. Cyr, Robert N. Bartone, and Ellen R. Cowie

2011 *Archaeology on the Line: Archaeological Investigations at the Native American Boundary Line Road Site, 159.1 ME, and the Historic Period, Boundary Line Mill Hamlet, ME 055-001, within the Bridgewater Land Port of Entry Modernization Project Area, Bridgewater, Aroostook County, Maine.* Prepared for U.S. Customs and Protection and Geo-Marine, Inc. Northeast Archaeology Research Center, Inc., Farmington, Maine.

## **EXHIBIT B**

**Archaeological Phase 0 Assessment  
for the Proposed Pickett Mountain Mine Project  
T6R6 WELS, Penobscot County, Maine**

prepared for:

Wolfden Resources Corporation  
1100 Russell Street  
Thunder Bay, ON P7B 5N2

prepared by:

Gemma-Jayne Hudgell, Ph.D.  
Christopher Brouillette  
and  
Robert N. Bartone, M.A.

Northeast Archaeology Research Center, Inc.  
382 Fairbanks Road  
Farmington, Maine 04938

July 1, 2022



**Archaeological Phase 0 Assessment  
for the Proposed Pickett Mountain Mine Project  
T6R6 WELS, Penobscot County, Maine**

**Table of Contents**

Table of Contents .....	ii
List of Figures .....	iii
I: Introduction .....	1
II: Environmental Setting.....	2
III: Pre-Contact Native American Context and Archaeological Sensitivity.....	4
IV: Post-Contact Historic Context and General Archaeological Sensitivity.....	9
V: Field Inspection and Delineation of Archaeologically Sensitive Areas .....	11
VI: Conclusion and Recommendations .....	16
References Cited .....	17

**Archaeological Phase 0 Assessment  
for the Proposed Pickett Mountain Mine Project  
T6R6 WELS, Penobscot County, Maine**

**List of Figures**

- Figure 1. Topographic map showing the location of the proposed Pickett Mountain Mine Project, T6R6 WELS, Penobscot County, Maine.
- Figure 2. Aerial photograph showing the location of the proposed Pickett Mountain Mine Project, T6R6 WELS, Penobscot County, Maine.
- Figure 3. Aerial photograph showing the location of defined archaeologically sensitive areas (ASAs) within the proposed Pickett Mountain Mine Project, T6R6 WELS, Penobscot County, Maine. Note also the location of previously identified Native American site 147.001.
- Figure 4. Map of the Maine biophysical regions showing location of the proposed Pickett Mountain Mine Project, T6R6 WELS, Penobscot County, Maine.
- Figure 5. Regional watershed map showing the location of the proposed Pickett Mountain Mine Project, T6R6 WELS, Penobscot County, Maine.
- Figure 6. Section of the Ekren and Frischkneck 1967 bedrock geologic map of the Island Falls quadrangle, showing the location of the proposed Pickett Mountain Mine Project, T6R6 WELS, Penobscot County, Maine.
- Figure 7. Wolfden map of the Pickett Mountain area of exploration, 2019, showing the generalized geology of the proposed Pickett Mountain Mine Project, T6R6 WELS, Penobscot County, Maine, and surrounding area.
- Figure 8. Wolfden geological plan of the Pickett Mountain area of exploration, 2019, showing the geology of the proposed Pickett Mountain Mine Project, T6R6 WELS, Penobscot County, Maine. The lines/dots mark boring locations.
- Figure 9. USDA Soils map of the proposed Pickett Mountain Mine Project, T6R6 WELS, Penobscot County, Maine.
- Figure 10. Timeline showing the major time periods of Native American history for Maine and the broader region.
- Figure 11. Map of tailing pond area showing location of previously identified site 147.001 (the Pickett Pond Site). From Bonnicksen et al. 1984:7, Figure 3.
- Figure 12. Profile sketch map of Pickett Pond basin surficial geology showing postglacial landforms. From Bonnicksen et al. 1984:6 Figure 2.

- Figure 13. Section of the Walling 1859 map of Penobscot County showing the location of the proposed Pickett Mountain Mine Project, T6R6 WELS, Penobscot County, Maine.
- Figure 14. Section of the Colby 1885 map of Penobscot County showing the location of the proposed Pickett Mountain Mine Project, T6R6 WELS, Penobscot County, Maine.
- Figure 15. Section of the Stuart 1894 map of the Timber Lands of Maine showing the location of the proposed Pickett Mountain Mine Project, T6R6 WELS, Penobscot County, Maine.
- Figure 16. 1940 topographic map showing the location of the proposed Pickett Mountain Mine Project, T6R6 WELS, Penobscot County, Maine. Note tote road passing to the north of project area and structure on tote road near Pleasant Lake.
- Figure 17. View southeast of skidder trail within the proposed Pickett Mountain Mine Project, T6R6 WELS, Penobscot County, Maine. Pickett Mountain is visible in the background. The photographer is standing on the hill in the northwest portion of the project area in the vicinity of ASA 3.
- Figure 18. View north towards the proposed Pickett Mountain Mine Project, T6R6 WELS, Penobscot County, Maine. The photographer is standing in the approximate location of previously identified site 147.001 looking towards ASA 5. The thick undergrowth in the southern portion of the project area is clearly visible. This thick vegetation also denotes the location of wetland areas at the head of Pickett Mountain Pond.
- Figure 19. View south of Wolfden geologists Don Dudek and John Breedlove at lithic outcrop ASA 1 in the eastern portion of the proposed Pickett Mountain Mine Project, T6R6 WELS, Penobscot County, Maine.
- Figure 20. Lithic outcrop at ASA 1 in the eastern portion of the proposed Pickett Mountain Mine Project, T6R6 WELS, Penobscot County, Maine.
- Figure 21. Sample from lithic outcrop at ASA 1 in the eastern portion of the proposed Pickett Mountain Mine Project, T6R6 WELS, Penobscot County, Maine.
- Figure 22. View northwest of lithic outcrop at ASA 2 in the central portion of the proposed Pickett Mountain Mine Project, T6R6 WELS, Penobscot County, Maine.
- Figure 23. Lithic outcrop at ASA 2 in the central portion of the proposed Pickett Mountain Mine Project, T6R6 WELS, Penobscot County, Maine.
- Figure 24. Samples from lithic outcrop at ASA 2 in the central portion of the proposed Pickett Mountain Mine Project, T6R6 WELS, Penobscot County, Maine.
- Figure 25. View west of part of lithic outcrop ASA 3 in the western portion of the proposed Pickett Mountain Mine Project, T6R6 WELS, Penobscot County, Maine.
- Figure 26. View east of part of lithic outcrop ASA 3 in the western portion of the proposed Pickett Mountain Mine Project, T6R6 WELS, Penobscot County, Maine.

- Figure 27. Samples from lithic outcrop at ASA 3 in the western portion of the proposed Pickett Mountain Mine Project, T6R6 WELS, Penobscot County, Maine. Note how well this material flakes using a geological hammer.
- Figure 28. View northwest of lithic outcrop ASA 4, located outside of the western edge of the proposed Pickett Mountain Mine Project, T6R6 WELS, Penobscot County, Maine.
- Figure 29. Lithic outcrop ASA 4, located outside of the western edge of the proposed Pickett Mountain Mine Project, T6R6 WELS, Penobscot County, Maine.
- Figure 30. Sample of lithic outcrop in ASA 4, located outside of the western edge of the proposed Pickett Mountain Mine Project, T6R6 WELS, Penobscot County, Maine.
- Figure 31. Lithic outcrop at ASA 6 in the central portion of the proposed Pickett Mountain Mine Project, T6R6 WELS, Penobscot County, Maine. Note that the lower rock seam appears to be an intact outcrop while the top appears to have been flipped or moved by heavy machinery.
- Figure 32. Sample of lithic outcrop in ASA 6, located outside of the western edge of the proposed Pickett Mountain Mine Project, T6R6 WELS, Penobscot County, Maine.
- Figure 33. Poor quality, reddish colored chert seam in the eastern portion of the proposed Pickett Mountain Mine Project, T6R6 WELS, Penobscot County, Maine. This chert was identified approximately 100 m south of ASA 1 (location marked on GPS with yellow dot).
- Figure 34. Sample of poor quality, reddish colored chert seam in the eastern portion of the proposed Pickett Mountain Mine Project, T6R6 WELS, Penobscot County, Maine. This chert was identified approximately 100 m south of ASA 1.
- Figure 35. Chert cobble, likely Munsungan material, recovered from glacial till in the vicinity of ASA 1 in the eastern portion of the proposed Pickett Mountain Mine Project, T6R6 WELS, Penobscot County, Maine (location marked on GPS with yellow dot).
- Figure 36. Chert cobbles, likely Munsungan material, recovered from glacial till in the southwestern corner of the proposed Pickett Mountain Mine Project, T6R6 WELS, Penobscot County, Maine (location marked on GPS with yellow dot).
- Figure 37. View northwest of gravel track in southwestern corner of the proposed Pickett Mountain Mine Project, T6R6 WELS, Penobscot County, Maine. The Pickett Mountain Pond stream is within the bushes at the right side of the photograph.
- Figure 38. View east of level till bench landform in southeast corner of the proposed Pickett Mountain Mine Project, T6R6 WELS, Penobscot County, Maine. Note Wolfden coring location at left of photograph (orange marker).
- Figure 39. View south of level landform in southeast corner of the proposed Pickett Mountain Mine Project, T6R6 WELS, Penobscot County, Maine. Note wetland beyond.

**Archaeological Phase 0 Assessment  
for the Proposed Pickett Mountain Mine Project  
T6R6 WELS, Penobscot County, Maine**

**I: Introduction**

The Northeast Archaeology Research Center, Inc. (NE ARC) has completed an archaeological phase 0 assessment of the proposed Pickett Mountain Mine Project on behalf of Wolfden Resources Corporation. The Pickett Mountain Property consists of 6,781 hectares of private land located in Township 6, Range 6, Penobscot County, Maine that was acquired in 2017 by Wolfden Mt. Chase LLC (a wholly-owned subsidiary of Wolfden Resources Corporation). In January 2020 Wolfden submitted a Petition to the Maine Land Use Planning Commission (LUPC) to rezone approximately 295 acres of the Property in support of a developing an underground metallic mineral mine. This area was subject to an archaeological phase 0 assessment. Subsequently, the project was redesigned and the parcel shifted to extend farther to the north and east. This new 415-acre rezoning area, inclusive of a 400-foot buffer, overlaps with the previous 295-acre parcel (an overlap of ~211 acres) (Figures 1 and 2). This new parcel was also subjected to a phase 0 study. The combined results of phase 0 studies of both parcels are presented herein.

The phase 0 work was designed to identify all areas that are sensitive for the presence of Native American or historic Euroamerican archaeological sites both within the mine project area and also at selected locations along the access roads that may be subject to improvement as needed, or to show that archaeological sites of potential significance are not likely to be present. Significant archaeological sites are those that meet eligibility criteria for listing on the National Register of Historic Places (NRHP). The assessment was conducted as part of the Maine LUPC permit application process, and meets guidelines and requirements determined by the Maine Historic Preservation Commission (MHPC).

The original 295-acre parcel was reviewed by the MHPC and was determined to exhibit moderate archaeological sensitivity for Native American archaeological sites based on the project location within the area of possible Ordovician or Silurian chert toolstone outcrops, as well as proximity to previously identified Native American site 147.001, which is located approximately 250 m (0.16 mile) south of the original project area on the edge of the Pickett Mountain Pond valley. Based on information from the MHPC, there is a low probability of post-contact Euroamerican archaeological sites being present, mostly being lumbering camps. In general, this description of sensitivity still applies to the new rezoning area given that there is considerable overlap.

The phase 0 assessment included background research, archaeological sensitivity modeling, and field inspection, including consultation with Wolfden geologists and walkover survey to locate bedrock

outcrops and assess their suitability for use as toolstone. Overall, six archaeologically sensitive areas (ASAs) were defined. Of these, four fall within the original project area and five fall within, or partially within, the new rezoning area. ASAs 1-4 and ASA 6 are areas of outcropping “cherty rhyolite”, which is a knappable lithic material of a type known to have been used by Native Americans to make stone tools. Of note, one outcrop, ASA 4, falls outside of both iterations of the project area (Figure 3). The project also possesses archaeological sensitivity for Native American archaeological habitation sites based on the presence of a fairly level till bench terrace located above Pickett Mountain Pond in the southeastern portion of the project and given the identification of site 147.001 within 250 m of the original project area and within 400 m of the southern boundary of the new rezoning area on a similar landform near the head of the same pond. Portions of this till bench located within the boundaries of the previous project area have been designated as ASA 5, and a small portion overlaps with the new rezoning area (see Figure 3). The project area is not considered sensitive for the presence of post-contact Euroamerican archaeological resources.

If detailed baseline study test work proceeds, archaeological phase I survey is recommended within ASAs 1, 2, and 6 as well as small portions of ASAs 3 and 5 in order to determine if archaeological site(s) of potential significance are present within the new rezoning area. A final plan for phase I survey, if required, will be developed in consultation with the MHPC.

## **II: Environmental Setting**

The Pickett Mountain Mine Project is located in elevated terrain in the southern portion of the Aroostook Hills Region of Maine (Figure 4). This region, as characterized by McMahon (1990: Appendix 7), extends from the Saint John River near Madawaska southwards to the Patten area. The Aroostook Hills are a region of gently rolling terrain that forms part of the eastern foothills of the northern extent of the Appalachian Mountain chain, and as such, more elevated and mountainous terrain is located to the west. The 1000' contour line forms the western boundary of the region, and elevations average between 800' and 1000'. Scattered mountains are present in the Winterville area and on a small pluton north of Shin Pond, and include those in the vicinity of the project: Mount Chase (2440'), located approximately 1.5 km (0.9 mi) south of the project; Hay Brook, Roberts, and Green mountains, 6.7 km (4.2 mi) northwest of the project; and Sugarloaf Mountain (1860'), 11.1 km (6.9 mi) west of the project.

The project is located within Penobscot River Drainage basin, specifically within the Mattawamkeag River sub-basin (Figure 5). High ground in the center of the project area creates a micro-

watershed, with the northern portion of the project area having northerly facing slopes and draining northward to Pleasant Lake/Mud Lake and the West Branch of the Mattawamkeag River, and the southern portion of the project facing south or southeast and draining southwards to Pickett Mountain Pond, which itself drains east then northwards, also into Mud Lake and the West Branch. The Mattawaumkeag River proper forms from the confluence of its East and West branches in Haynesville, 50 km (31 mi) southeast of the Project, then flows just over 80 km (50 mi) southwest to join the Penobscot River in Mattawaumkeag. In turn, the Penobscot River is also formed from its East and West branches, which meet about 17 km (11 mi) upstream of Mattawaumkeag, then flows for a further 175 km (109 mi) south into the Atlantic Ocean at Penobscot Bay, passing through the city of Bangor (which lies approximately 145 km [89 mi] south of the project). Including the East and West Branches, the Penobscot is the second longest river system in Maine, and the longest located entirely within the state. Its drainage basin measures approximately 22,300 square kilometers (8,610 square miles) (U.S. Geological Survey 2012).

Bedrock of the Aroostook Hills region is almost entirely composed of weakly metamorphosed pelites, sandstones, and some limestones. Intrusives include a belt of metavolcanic rock that cuts across the central portion of the region and the quartz diorite pluton that underlies Mount Chase. The major structural feature, the Weeksboro-Lunksoos anticline, passes through the project area roughly west-east. Within the project area north of the anticline, the northern quarter (approximate) contains Rockabema quartz diorite, and the remaining central and southern portions south of the anticline are mainly Mount Chase volcanics (felsic and mafic), including quartz diabase. The Grand Pitch formation, consisting of slate and quartzite, extends slightly into the northwestern portion of the project (Figures 6 and 7) (Ekren and Frischknecht 1967; McMahon 1990: Appendix 7; Osberg et al. 1985). A slightly more detailed map of the project area produced by Wolfden geologists illustrating their target, the massive sulphide deposit, also shows the presence of mudstone and siltstone, and mafic breccia (Figure 8).

The climate of the region varies considerably from north to south and is intermediate between the Saint John Uplands to the west, and the Aroostook Lowlands to the east. Winter temperatures and annual precipitation and snowfall are higher in southern parts of the region, including the project area, due to higher elevations. Near Patten, average precipitation is 43", and snowfall averages 120". The average minimum temperatures range from 4° F near Patten to -5° F near Squa Pan (Maine Forest Service 2000).

As a result of climate, thin soils, and high elevations, vegetation is of limited variety compared to other regions of the state. The project area generally falls within the spruce-fir northern hardwoods zone, and principal arboreal species include red spruce, balsam fir, white pine, hemlock, white cedar, red maple, sugar maple, paper birch, yellow birch, aspen, tamarack, and black ash (McMahon 1990; Westveld et al.

1956). The 1000' contour also roughly defines the northern and western limit of eccentric bog distribution in Maine. Modern biotic communities of the region reflect historic and modern land use practices, particularly as a result of land clearing and forestry.

The rolling terrain of this portion of Maine is covered by thin glacial drift, and some portions of the Aroostook Hills (especially in the eastern portion) have extensive but scattered deposits of glaciolacustrine sediments on which cedar swamps and peatlands have developed. Immediately around Pickett Mountain Pond are surficial deposits derived from swamplands, including Burnham silt loam 0-3% slopes, which is frequently ponded, however these soils do not extend into the project area. The project is elevated above the pond and includes soils derived from glacial till, including ablation till – which tends to be loose, stony, and sandy with fair to good drainage – and basal till, which is commonly fine grained and compact, with low permeability and poor drainage (Newman 1981). Much of the northern portion of the project area contains Plaisted loam soils (8 to 15% slopes), very stony, formed from coarse-loamy lodgment till. The central portion of the project area possesses Dixmont very stony silt loam soils, 2 to 8% slopes, formed from coarse-loamy supraglacial meltout (ablation) till derived from slate and/or phyllite, while southwestern portions contain Thorndike-Winnecook complex (3 to 8 % and 8 to 15% slopes), rocky, which is a shallow loam to silt loam formed from loamy-skeletal subglacial (basal) till. Most of the southeastern portion contains Thorndike channery silt loam, 8 to 15% slopes, also formed from loamy-skeletal subglacial till. A small portion of the southeastern part of the project area is mapped as Rock outcrop-Thorndike association, 15 to 25% slopes, very stony, essentially consisting of very thin Thorndike soils over rock outcrops (Figure 9) (USDA 2020).

### **III: Pre-Contact Native American Context and Archaeological Sensitivity**

#### **General Archaeological Sensitivity**

The Native American history of the region is divisible into four major periods (Bourque 2001; Petersen 1995) (Figure 10). These include the following:

- Paleoindian period, ca. 9000-7000 B.C.
  - Early Paleoindian period, ca. 9000-8300 B.C.
  - Middle Paleoindian period, ca. 8300-8100 B.C.
  - Late Paleoindian period, ca. 8100-7000 B.C.
- Archaic period, ca. 7000-1000 B.C.
  - Early Archaic period, ca. 7000-5500 B.C.
  - Middle Archaic period, ca. 5500-4000 B.C.
  - Late Archaic period, ca. 4000-1000 B.C.
- Ceramic period, ca. 1000 B.C.-A.D. 1550



- Early Ceramic period, ca. 1000-100 B.C.
- Middle Ceramic period, ca. 100 B.C.-A.D. 1000
- Late Ceramic period, ca., A.D. 1000-1550
- Contact period, ca. A.D. 1550-1750

Native occupation dating to all of these time periods has been identified throughout Maine, including the forested and mountainous interior of the state. According to the MHPC site files, there is one known Native American site located in close proximity to the project: site 147.001, located less than 1 km from the southern edge of the project area. Given its relevance to the current project, this site is described in greater detail below. The next closest documented sites are located about 14 km (8.7 mi) west-southwest of the project along the Seboeis River, and are also detailed further below. While there is not a high density of known Native American sites in the vicinity of the project, the general paucity of recorded Native American sites in this part of Maine reflects a lack of archaeological research rather than actual Native American presence and settlement within the region. For example, the Penobscot River and its associated watersheds are central to the culture of the Wabanaki people and in particular the Penobscot Indian Nation. When permit related or avocational archaeology has been performed in this region, the investigations frequently result in the identification of Native American archaeological sites across the landscape.

Much identification and documentation of sites has followed recent cultural resource management (CRM) investigations in the local area following the development of the Katahdin Woods and Waters National Monument (KWWNM). NE ARC has recently completed three projects in the local area, including one directly for the KWWNM at Lunksoos Camps, plus two nearby trail developments. Archaeological sites were newly defined at all three projects, including a series of six sites located along the Seboeis River in T5R6 and T5R7 dating from the Late Archaic period through to the Late Ceramic period (Beale et al. 2019). At 14 km distant, are some of the closest documented sites to the project. Additional sites are located farther downstream at the confluence of the Seboeis, Wassataquoik and Penobscot Rivers, beginning about 25 km (15.5 mi) southwest of the project area (Loftus et al. 2020), as well as along the East and West branches of the Penobscot and the Penobscot River proper (Beale et al. 2018; Cowie 2017), and around Grand Lake Matagamon, the headwaters of the East Branch of the Penobscot (about 25 km west of the project), to name a few. All of these sites yielded an assortment of flakes and stone tool fragments of a variety of lithic raw materials gathered from various locales within Maine, including Kineo and Traveler rhyolite, Munsungan and Wassataquoik chert, and quartz (C. Sockalexis [Penobscot Nation Tribal Historic Preservation Office], personal communication, May 2020).

Likewise, intensive archaeological research in the area around the Munsungan Lake area, primarily related to Native American use of high-quality chert material from the Munsungan geological formation, has led to the identification of well over 100 archaeological sites, including quarries, workshops, and habitation sites (MHPC site files). Clusters of sites are particularly well known on Norway Bluff Mountain; at Munsungan and Chase Lakes; at Mooseleuk Lake; and at Round Mountain Pond (Bonnichsen 1984; Bouras and Evans 2006; Hudgell et al. 2016). Although the Munsungan area is located about 45 km (28 mi) northwest of the project area, the network of rivers and streams in the local area ensures that there are multiple transportation routes for the movement of Munsungan chert material. Local waterways, including the Mattawaumkeag River, the East Branch and the Seboeis are known to have been used for millennia as canoe routes, for example to various lakes in the area, onwards to the Allagash and Aroostook watersheds, and also to the Munsungan area (Cook 2007). Campsites in use today by canoeists and fishermen were therefore likely used by prehistoric travelers as well. To the southwest of the project, the aforementioned valley of Wassataquoik Stream and the surrounding hills are also known as good sources for chert lithic material, with associated Native American quarry sites (Georgiady and Brockmann 2002). As well as chert material, a highly regarded source of rhyolite comes from Traveler Mountain, which is located about 30 km (18.6 mi) west of the project area.

#### **Previously Identified Site 147.001**

There is one recorded Native American archaeological site in the vicinity of the project: site 147.001, which is located approximately 250 m (0.16 mile) south of the original project area and about 400 m south of the new rezoning area, on the edge of the Pickett Mountain Pond valley (see Figure 3). The site was identified in 1984 during initial survey for the Chase Mountain mine tailing pond project, which was conducted by the University of Maine at Orono on behalf of the E.C. Jordan Company (Bonnichsen et al. 1984). The site was found at the location of a proposed dam within a small southwest-northeast trending basin, where a small stream flows through the basin to Pickett Mountain Pond (Figure 11). The lateral margins of the basin are characterized by what appear to be glacial kame terraces, and site 147.001 is located on the first till bench immediately below one of these terraces on the southwest side of the basin at about the 1100 ft contour (Figure 12). Given the location and formation of terraces around the basin, Bonnichsen et al. concluded that Pickett Mountain Pond and its basin formed from the melting of a large stagnant ice block (i.e., is a kettle pond), and was thus larger during late glacial times than today. It appears that the occupants of the site camped at the head of a bay where a freshwater stream entered the pond, rather than adjacent to a small perennial stream as is the case today (Bonnichsen et al. 1984:13).

The site measures about 200 sq m in extent (about 2,150 sq ft) and recovered artifacts include a biface fragment and 69 pieces of lithic debitage (flakes), produced during the manufacture or refurbishment of bifacial tools with distinctive scalloped edges. The flaked stone from the site is documented as a “volcanic tuff”, and has been degraded/naturally chemically weathered to a tan or white color. The source of the material was not located by the original excavators, but was not believed to have been obtained from stream bed cobbles, as no cobble cortex was identified on any of the flakes.

Tools (or evidence for their manufacture) similar to those from site 147.001 have been recovered from the Vail Paleoindian site in western Maine, as well as from the Round Mountain Pond site near Munsungan Lake, north of the project area. Interestingly, although undated, the Round Mountain Pond site is similarly situated on the first till bench below a kame terrace (Bonnichsen et al. 1984:27). Given the location of the site just below a kame terrace, as well as the technological grammar of artifact manufacture and patterning of artifact recovery, site 147.001 is believed to represent a single occupation dating to the early postglacial period, i.e., the beginning of the Holocene, i.e., the later portion of the Paleoindian period or Early Archaic period (Bonnichsen et al. 1984:iv).

The site is thought to represent an occupation dating to the Late Paleoindian or Early Archaic periods of Native American history for the region, ca. 10,000-7,500 years ago.

### **Native American Toolstone Use**

As noted above in the general environmental section, geologic maps indicate that Mount Chase volcanics, Rockabema quartz diorite, quartz diabase, and potentially some quartzite and slate underly the project area. Quartzites and fine-grained volcanics such as rhyolite or felsite have certainly been utilized by precontact peoples to manufacture stone tools, although regionally, cryptocrystalline silicates such as cherts were generally preferred, as they give a particularly good result for knapping: i.e., they break relatively easily and predictably, and produce a fine, sharp edge. The nearest defined chert outcrops are mapped at approximately 8 km (5 mi) east of the project area (Ekren and Frischknecht 1967), while an exposure of Wassataquoik chert is located approximately 10 km (6.2 mi) southwest of the project area (Neuman 1967), and the Munsungan formation begins approximately 45 km (28 mi) northwest of the project (Osberg et al. 1985). Red, gray, and black cherts were also noted by Bonnichsen et al. as being locally available in stream bed and glacial till deposits (Bonnichsen et al. 1984:3). Additionally, while not categorized on the overview geological maps of the area (i.e., Ekren and Frisschknecht 1967, Osberg et al. 1985), Wolfden geologists have identified chert within the project area, as listed in the “*Geology and Mineralization*” section of the Pickett Mountain Property page:

“The Pickett Mountain [massive sulphide] deposit is located on the southeast limb of the northeast-trending Weeksboro-Lunksoos anticlinorium. The anticlinorium is cored by black shales and sandstones of the Grand Pitch formation of Cambrian age; these comprise the deepest footwall rocks at Pickett Mountain. The sediments are overlain by intermediate to rhyolitic volcanic and volcanoclastic rocks (middle Ordovician) which host the deposit. The immediate footwall to the deposit comprises a sheared footwall breccia that is characterized by intense, pyritic, sericitic and chloritic alteration proximal to mineralization. The massive sulphide deposit is in turn overlain by hanging-wall tuffs, an **iron-rich chert**, mafic volcanic rocks and an upper-most sequence of shales, some of which are carbonaceous.”

*(wolfdenresources.com/projects/pickett-mountain-maine/; emphasis added.)*

As well as chert, rhyolites including Kineo and Traveler varieties (from Moosehead Lake, 120 km southwest of the project, and from just north of Katahdin 45 km west of the project, respectively) have been identified in regional artifact assemblages. To reiterate, the artifacts from the nearby Pickett Pond archaeological site, 147.001, are defined by the excavators as “volcanic tuff” and are described as weathered to tan or white.

### **Predictive Modelling and Summary**

Finally, predictive modeling for Maine prehistoric sites, as developed by the MHPC, indicate that the project area is generally archaeologically sensitive (Spiess and Smith 2016). Two models are pertinent. One model account for most of the Paleoindian sites in Maine and indicates that sites of this period most commonly occur on well drained sandy soils adjacent to small water bodies that are usually not accessible by canoe. Adjacent water bodies can include first or second order streams, marshes, or kettle hole ponds, such as Pickett Mountain Pond. The second pertinent model accounts for 90% of prehistoric habitation sites, which occur on level landforms adjacent to canoe navigable water. Pleasant Lake/Mud Lake, to the north of the project area, links to canoe navigable waterways. Proximity of the project to Pickett Mountain Pond and Pleasant Lake/Mud Lake, along with their associated waterways and wetlands, therefore, indicates moderate sensitivity for the presence of Native American archaeological sites of all time periods. Most specifically, given the proximity of known early Holocene site 147.001 (Paleoindian or Early Archaic) at the edge of a former kettle pond, the project area is particularly sensitive for the presence of sites of a similar date.

In sum, background review and predictive modeling indicates that the project area in general is sensitive for the presence of Native American habitation sites, potentially dating to all recognized time periods, but particularly dating to the early portion of the Holocene, i.e., the Paleoindian or Early Archaic periods of Native American history for the region. Sensitivity is indicated by the geological potential for

toolstone resources and thus potential for quarry or workshop sites within the project area; proximity to Pickett Mountain Pond and its wetlands and drainages tributary to the Mattawaumkeag River; and the presence of a known Native American archaeological site within 400 m of the southern boundary of the new rezoning area.

#### **IV: Post-Contact Historic Context and General Archaeological Sensitivity**

The township of T6 R6 WELS within which the project area lies is situated along the eastern edge of Penobscot County, and is bordered to the north by the township of T7 R6, to the west by T6 R7, and to the south by the town of Mount Chase. To the east is Moro Plantation, within Aroostook County. Townships are minor civil divisions that have no organized local government, as opposed to plantations, towns, or cities, which do; as such, townships are administered directly by the state. Townships occasionally have names but are commonly designated by a township and range identification, i.e., Township 6 Range 6. WELS is an abbreviation for "West of the Easterly Line of the State," referring to the north-south line extending from Hamlin in the north to Amity in the south in Aroostook County. Maine currently has 421 townships making up its Unorganized Territory of 9,284,166 acres of land, of which 7,550,783 acres are in the Tree Growth current use program, and 1,167,795 acres are exempt from property tax, such as State and Federal land. There are approximately 379 miles of summer roads and 570 miles of winter roads in the Unorganized Territory, and a total full-time resident population of 7,900 (Office of the State Auditor 2015). Given that townships are not organized and most often have a minimal resident population, the history of nearby towns or the more general area is more telling than is a specific history of township T6R6.

The first substantial exploration of the area by non-native Americans was an 1825 survey conducted on behalf of the Maine Boundary Commission, which sought to resolve issues stemming from timber cutting, initially on the Aroostook and Madawaska rivers, from a "mistaken view of the boundary line." The survey certainly followed the Seboeis and Aroostook rivers to the west and north of the project area, respectively, although how close the surveyors came to the project area itself is not clear (Williams 1882:624).

Penobscot County was formed on April 1, 1816 from the northern part of what was then Hancock County, and later gave up territory to form Piscataquis and Aroostook counties. As with many counties, towns and borders changed throughout the early 19<sup>th</sup> century. For example, Moro Plantation, which contains the eastern portion of Pickett Mountain Pond, is the remaining fragment of the former

Rockabema “mega” plantation, which was formed from T6 R5 WELS (Moro), T7 R5 WELS, and the northwest quarter of T6 R4 WELS (Merrill) in 1846. In 1859 Maine abolished mega-plantations and Rockabema was split, with Moro eventually formed from one of the sections in 1870, and formally organized in 1891 (Historical Records Survey [Maine] 1940).

Moro, along with Mount Chase – the next town south of the project area – and Patten, one town south again, were some of the first permanently settled townships in proximity to the project area. The first permanent residents arrived ca. 1837-1838, and by 1860 the population of Moro was 171 and of Mount Chase was 250, although that of Mount Chase had only slightly increased to around 300 by the early 20<sup>th</sup> century, dropping to around 200 in recent times (U.S. Census Bureau). Early workers were attracted to the area for opportunities working for lumber companies, and in 1881, the area was well wooded, with a saw mill on Crystal Brook at the eastern side of Mount Chase (Varney 1881), while another contemporary work pointed out that farming was another major occupation (Williams 1882).

Following the Civil War, the European and North American Railroad (one of many companies in the Bangor area) extended its lines along the Penobscot River from Bangor to Mattawamkeag, ca. 1869 (Cook 2020), and Mount Chase was "on the stage line from the European & North American Railroad at Mattawamkeag to Fort Kent in the extreme north of the State, on the St John" (Williams 1882:193). Residents and tourists could take advantage of the 50-mile stage route from Mattawamkeag to Mount Chase, and supplies could be shipped in and goods or wild game out more readily.

Throughout the Maine woods, the infrastructure that developed to support the logging industry also drew hunters, anglers, hikers, and other recreationists, as recreational hunting became more popular with increased ownership of civilian firearms following the Civil War (The White House Office of the Press Secretary 2016). Following his travels in the 1840s and 50s, Henry David Thoreau described every log hut in the woods as a public house (Thoreau 1864). Thoreau spent time along the West Branch of the Penobscot and on the slopes of Katahdin, but his well-described travels probably brought him no closer than 40 or 50 miles south of the project area. In general, hunting and fishing opportunities of the Maine north woods encouraged development of interior sporting camps as an alternative to resort facilities along the Maine coast (Starkey 1947:166-167). The Shin Pond House in Shin Pond village, Mount Chase was established in the 1870s, later becoming the Crommett House and Farm (Williams 1882). Shin Pond village, situated between Upper and Lower Shin Pond, is approximately 7.5 km (4.6 mi) southwest of the project area. Sporting camps have continued as a means of support to the present time, and the numerous ponds and brooks in the area were thus likely popular destinations throughout the 19<sup>th</sup> and 20<sup>th</sup> centuries.

Despite the possibility of logging and some recreational activity in the general area of the project in the 19<sup>th</sup> century, 19<sup>th</sup> century maps including Walling’s 1859 map, Colby’s 1885 atlas and Stuart’s 1894

map (Colby 1885; Stuart 1894) do not show any roads or structures within, or in close proximity to the project (Figures 13-15). These show the path of what is now Route 11 to the east of the project area, as well as a road passing in a northwesterly direction through Mount Chase, between the Shin Ponds/through Shin Pond village, west and south of the project area. These road alignments are still in use today. A 1940 topographic map shows a number of tote roads extending from what is now Route 11 northwestwards, including what is today named the Pleasant Lake Road and which skirts the northern edge of the project area (Figure 16). The closest structure to the project area marked on any of the reviewed maps first appears on this 1940 map, and is an unmarked structure, possibly a logging camp, located approximately 1 mile north of the project area and a short distance from the south shore of Pleasant Lake (Mud Lake). No structures or historic tote roads are marked within the project area itself.

In sum, background research indicates low sensitivity for archaeological resources associated with 19<sup>th</sup> century logging and lumbering activities, as most activity appeared to have occurred along roads and rivers outside of the project area. Likewise, there is low sensitivity for archaeological resources associated with secondary activities including recreational hunting, fishing, and camping, as such activities were more likely to have occurred much closer to the shores of Pickett Mountain Pond and Pleasant Lake.

## **V: Field Inspection and Delineation of Archaeologically Sensitive Areas**

### **General Project Description**

As noted, given the changes in project plans, the field inspection was undertaken in two episodes. The first was conducted by NE ARC Assistant Director Dr. Gemma Hudgell on June 24 and 25, 2020 and focused on the original project parcel. A second, focusing on the updated and expanded study area (the new rezoning area) was conducted by NE ARC Project Director Christopher Brouillette between May 10 and 12, 2022. Overall, the project is located primarily on the eastern slopes of an unnamed hill, and also contains a number of lower hills and knolls. The highest elevations are in the southwestern portions of the study area, with the lowest to the east, in proximity to Pickett Mountain Pond, and the north. Much of the project area possesses gradual to medium slopes, with level areas in the central sections of the project; as such, the parcel is gently rolling with the steepest portions towards the western edge, including a hill in the southwest corner and a low, rocky knoll in the approximate center with moderate slopes southeastwards towards Pickett Mountain Pond. A few rocky outcrops and glacial erratics were noted but there are no 'cliff edge' features, talus slopes, or extensive areas of exposed rock.

A system of gravel roads cut across the project area from northeast to southwest as well as northwest to southeast, and follows fairly level portions of the project area before descending down a moderate to steep slope at the southwest edge of the project and then continuing around on level landforms towards the southern side of Pickett Mountain Pond. A perennial stream is located at the southern edge of the original project area, draining eastwards into Pickett Mountain Pond, while a series of swales/head of draws on the eastern side of the hill drain eastwards and southeastwards towards Pickett Mountain Pond. At the time of the field inspection Maine was witnessing a drought, but it is possible that some of these draws might represent the location of seasonal springs.

The project area is forested with a mixture of hard- and softwood growth, but aerial photos indicate that almost the entirety of the project area has been logged since the 1990s. At the time of the 2020 field inspection, the northwestern portion of the project had been very recently logged, and the area was open with piles of brush still present (Figure 17). This area still retained a few large hardwoods as well as some stands of fir and some underbrush of young birch and poplar. Recent skidder tracks were unvegetated and the ground surface was clearly visible. Much of the northeastern and central portion of the project area possessed slightly more mature trees (mainly deciduous varieties including maple, poplar, and birch) with relatively little underbrush, and so visibility was still reasonable, although the ground surface was covered with leaf litter. The southernmost edge of the project in proximity to Pickett Mountain Pond became increasingly heavily vegetated with mature fir and cedar and a thick underbrush, substantially negatively affecting visibility (Figure 18). At the time of the 2022 field inspection, the eastern portion of the new rezoning area had been recently logged and exhibited many of the same characteristics previously described.

The majority of the project area was inspected, given good access from logging roads. As noted, although the entirety of the project area is wooded, most portions have either been recently logged or possess relatively little underbrush, affording reasonable or good visibility to a distance of up to 60 m (200 ft), which allowed for wide transects to be walked yet to still allow inspection of a broad area. The only exception was the thick brush at the southern edge of the project, which possessed low visibility of around 5-10 m (16-32 ft); this area was walked as two closely spaced parallel transects to gain best coverage. Access roads were also walked, including those outside of the project area which are not marked as tote roads on topographic maps (e.g., not marked on Figure 1).

The location of bedrock outcrops and level areas close to water, and thus potentially suitable for habitation, were the focus of the field inspection. All visible bedrock outcrops were inspected and marked with a hand-held GPS, as were potentially habitable landforms. Wolfden geologists Don Dudek and John Breedlove were also in the project area on the dates of the 2020 field inspection and assisted with initial



geological identifications. Given their intimate knowledge of the geology of the project, combined with extensive coverage during the archaeological field inspection, NE ARC are confident that all major geological outcrops within the project area have been identified. Samples were obtained from all lithic outcrops with potential for use as toolstone, and samples were also obtained on cobbles and pebbles present in glacial till.

### **Defined Areas of Archaeological Sensitivity**

As detailed below, a total of six areas of archaeological sensitivity (ASAs) were identified throughout both iterations of the project parcel, although note that one of these (ASA 4) falls outside of either of the defined project areas and was located on an initial “walk in” or test of accessibility (see Figure 3). Five of these ASAs (1-4 and 6) are outcrops of potential toolstone. The sixth, ASA 5, is a level landform determined to be sensitive for the presence of Native American habitation sites.

### *Lithic Resources*

The majority of rock outcrops within either iteration of the project area are coarse grained or low-grade material and thus unsuitable for tool making. However, a total of five distinct areas, ASAs 1-4 and ASA 6, were found to include outcrops of material suitable for use as toolstone (see Figure 3). All are a “cherty rhyolite”, which is a fine-grained volcanic material that grades from dark to light gray and also includes a banded gray and pink variety (Figures 19-31). As can be seen from the photographs, this material is gray or gray and pink when freshly fractured but weathers to white when exposed. While other materials less suitable for toolmaking can also weather to a similar pale color, this weathering nevertheless makes for high visibility of outcropping material for easy location by Native American peoples searching for suitable toolstone. Geological samples were obtained from all potential toolstone outcrops, either from this season’s freeze-thaw material or from pieces obtained with a geological hammer, and are illustrated in Figures 21, 24, 27, 30, and 32. All outcrops defined as ASAs produced material suitable for flaking; flake morphology as produced via geological hammer is most clearly seen in Figure 27 (samples from ASA 3). All identified outcrops are located roughly parallel to the Weeksboro-Lunksoos anticline in the central portions of the project.

From the description in the MHPC site files, it is assumed that the “cherty rhyolite” volcanic material recovered from the project area is similar to, if not the same as, the artifactual material recovered from previously identified site 147.001: in particular, the description of white to tan weathering of the site material is reflective of similar weathering effects noted at the outcrops within the project area. Although no signs of Native American use of the material was identified during the field inspection, this

was only a cursory examination, and only the visible (above current ground surface/unvegetated) portions of outcrops have been considered.

No good quality/knappable chert outcrops were identified, although a poor-quality and highly fragmented chert seam of very limited extent is present in the southern portion of the project area (Figures 33 and 34). This material did not fracture conchoidally when sampled but instead had a platy breakage pattern. Assorted chert cobbles are also present in glacially deposited till that overlies much of the project (Figures 35 and 36), thus corroborating Bonnichsen's description of materials present in the local area (Bonnichsen et al. 1984:3).

#### *Potential Native American Habitation Sites*

Following the predictive model, the field inspection focused on drainages, wetland margins, and distinct topographic features that may have been a focal point for Native American activity, although as mentioned virtually the entirety of the project area was walked.

As noted, a few swales are present along the eastern slopes of the high ground within the project area, that would feasibly be the location of springs or ephemeral drainages in wetter conditions. However, these areas were also generally sloped, and would not have been suitable for encampments. The northeastern extent of the overall project area to the north of the access road (above the 1,200 ft contour) is level ground, but is not near any mapped water resource, and no potential spring holes, stream beds, swales, or heads of draw were identified in this area.

The Pickett Mountain Pond stream cuts through the southwestern corner of the original iteration of the project area. This area is particularly steeply sloped and runs alongside a gravel road (Figure 37). Where the stream meets the original project boundary, it enters a wetland area. The wetland margin was walked and was found to correspond approximately with the 1,100 ft contour. The only level landforms in proximity to the stream are located in wetland areas (see also Figure 18).

Immediately above (north of) the wetland, between the 1,090 to 1,140 ft contours, lies a set of relatively level to gently sloping terrace landforms. Eastern portions of this level area have been partially disturbed by Wolfden coring activity, however the presence of skidder trails and clearing in this area allow a clear view of the level landform and also of the till-derived soils (Figure 38). Immediately to the south is a slightly lower, level landform that borders the wetland area (Figure 39). Vegetation in this area is relatively thick, and it was not possible to tell if two distinct terraces are present, or if one slopes into the other; however, following the topographic and surficial geology descriptions of the Pickett Mountain Pond basin in Bonnichsen et al. (1984), the overall landform or set of landforms is interpreted as a till bench and/or kame terrace. As detailed above, previously identified Native American site 147.001 is located on

a till bench just below a kame terrace at approximately the 1,100 ft contour, on the south side of a stream/wetlands draining into Pickett Mountain Pond. Following the 1,100 ft contour around the pond, it appears that the landform set within the original project area forms the northern portion of this till bench and kame terrace pair, and is thus an extension of the same till bench as that of site 147.001 (see Figure 3). At minimum, this represents a similar landform that would have been a choice area for habitation at a similar time in the past. The till bench/kame terrace landform has thus been designated as archaeologically sensitive for the presence of Native American sites. A small portion of this landform extends into the new rezoning area.

The location of previously identified site 147.001 was also briefly inspected in order to gain an understanding of the similarity of the landforms. The site location has been estimated from the schematic maps provided in Bonnicksen et al. (1984; see Figure 11 of this report), and appears to lie on, or close to, the gravel track that passes to the west and south of the project area (see Figure 3). The apparent site landform does appear to be level and immediately overlying thickly vegetated landforms, as shown in Figure 18.

#### *Historic Euroamerican Archaeological Sensitivity*

Regarding post-contact, Euroamerican archaeological resources, no evidence of logging camps or activity other than very recent material (oil cans and pallets placed within gravel pull-offs) were noted within the project or along access roads. Nineteenth and twentieth century historic and USGS maps of the area record the presence of a potential logging camp a short distance from the south shore of Pleasant Lake, approximately 1 mile north of the project area, but no structures or historic tote roads are marked within the project area itself. Thus, the project area is considered to possess low sensitivity for the presence of Euroamerican archaeological sites.

#### *Non-Sensitive Areas*

Archaeological sites are considered unlikely to be present within all other portions of the proposed project area outside of the defined ASAs. All other portions of the project area were deemed to have low sensitivity due to slope, uneven terrain, disturbance, poor drainage/the presence of wetland areas, the lack of lithic materials or presence of only poor quality materials, or lacked other sensitivity factors.

## VI: Conclusion and Recommendations

An archaeological phase 0 assessment of the proposed Pickett Mountain Mine Project indicates that five areas of the proposed project are archaeologically sensitive for the presence of Native American archaeological sites (see Figure 3). All five areas extend, at least partially, into the current project area, i.e., the new rezoning area. Four of these ASAs (ASA 1-3 and 6) are locations of outcropping “cherty rhyolite”, which is a knappable lithic material of a type known to have been used by Native Americans to make stone tools. The artifacts from the nearby previously identified Native American site, 147.001, may be of this material, or a very similar type. These areas are defined as sensitive for archaeological sites representing Native American quarry or workshop sites. An additional outcrop has been defined as ASA 4 however this is located outside of both the original project area and the new rezoning area.

The wider project also possesses archaeological sensitivity for Native American archaeological habitation sites, within an area defined as ASA 5. ASA 5 is extensive within the former project area and very slightly overlaps into the new rezoning area. Sensitivity is based on the presence of a fairly level till bench terrace located above Pickett Mountain Pond in the southeastern portion of the project, and given the identification of site 147.001 within 400 m of the southern boundary of the new rezoning area on a similar landform near the head of the same pond.

The project area is not considered sensitive for the presence of Euroamerican archaeological resources. All areas outside of the defined ASAs are considered to possess low sensitivity for the presence of Native American archaeological sites.

If detailed baseline study testwork proceeds, archaeological phase I survey is recommended in areas of archaeological sensitivity that fall within the new rezoning area in order to determine if archaeological sites of potential significance are present. This includes the entirety of ASAs 1, 2, and 6 as well as portions of ASAs 3 and 5. As stated in the RFQ, proposed phase I survey approaches include the excavation of up to 50 standard sized 0.5 m x 0.5 m test pits, to be placed in areas of archaeological sensitivity: i.e., on the till bench terrace and also around the potential toolstone outcrops. In lieu of test pit excavation, some removal of surface detritus, including duff and leaves, is also suggested around the potential toolstone outcrops, as flaking debris may be preserved subsurface in these areas. A final plan for phase I survey, if required, will be developed in consultation with the MHPC.

## References Cited

Beale, David W., Robert N. Bartone and Gemma-Jayne Hudgell

2019 *Archaeological Phase I Survey and Phase II Testing of the Proposed Seboeis Trail Project (MHPC #1439-16), T5R7 and T6R7 WELS, Penobscot County, Maine*. In preparation for CES, Inc. and the Butler Group. Northeast Archaeology Research Center, Inc. Farmington, Maine.

Beale, David W., Gemma-Jayne Hudgell, Robert N. Bartone and Ellen R. Cowie

2018 *Archaeological Phase I Survey and Phase II Testing of the Katahdin River Trails Project*. In preparation for CES, Inc. Northeast Archaeology Research Center, Inc. Farmington, Maine.

Beginning With Habitat

2018 Electronic Source, [https://www.maine.gov/dacf/mnap/focusarea/east\\_branch\\_penobscot\\_focus\\_area.pdf](https://www.maine.gov/dacf/mnap/focusarea/east_branch_penobscot_focus_area.pdf). Accessed 2018.

Bonnichsen, Robson

1984 Paleoindian Sites in the Munsungun Lake Region, Northern Maine. *Current Research* 1: 3–4.

Bonnichsen, Robson, Robert Birnie, and Dee Hungerford

1984 *Archaeological Reconnaissance and Testing of the Chase Mountain Taling Pond Site*. Submitted to E.C. Jordan Company. Center for the Study of Early Man, Orono. Report on file with the MHPC.

Bouras, Edward, and Garret Evans

2006 A New Look at Munsungan: Excavations at the Ray Carter Site. *The Maine Archaeological Society Bulletin* 46(1): 25–56.

Bourque, Bruce J.

2001 *Twelve Thousand Years: American Indians in Maine* (with contributions by Steven L. Cox and Ruth H. Whitehead). University of Nebraska Press, Lincoln and London.

Colby, George N.

1885 *Map of Penobscot County, Maine*. George No. Colby & Co. Houlton, Maine.

Cook, D. S.

2007 *Above the Gravel Bar: The Native Canoe Routes of Maine*. 3rd Edition. Polar Bear & Company, Solon, Maine.

Cook, William

2020 *Early railroads in Bangor and vicinity*. Bangor Public Library. Electronic resource: [digicom.bpl.lib.me.us/railroad\\_img/](http://digicom.bpl.lib.me.us/railroad_img/), accessed 2020.

Cowie, Ellen R.

2017 *Katahdin River Trails Archaeological Phase II Testing End-of-Field Letter*. Prepared for CES, Inc. Northeast Archaeology Research Center, Inc. Farmington, Maine.

Ekren, E. B., and Frischknecht, Frank. C.

1967. Geological-geophysical investigations of bedrock in the Island Falls [15-minute] quadrangle, Aroostook and Penobscot Counties, Maine: U. S. Geological Survey, Professional Paper 527. *Bibliography of Maine Geology 2*.

Georgiady, J., and M. Brockmann

2002 *Prehistoric Lithic Types of New England*. Franklin Printing, Farmington.

Historical Records Survey (Maine)

1940 *Counties, cities, towns, and plantations of Maine: a handbook of incorporations, dissolutions, and boundary changes*. Maine State Archives, Portland, Maine.

Hudgell, Gemma-Jayne, Robert N. Bartone, and Ellen R. Cowie

2016 *The View from Norway Bluff: A Chert Quarry and Workshop Site in Northern Maine. Post Review Impacts to Historic Properties through Controlled Archaeological Surface Collection of the Norway Bluff Quarry Site, 155.19/94 ME, at the U.S. CBP Radio Communications Tower Facility Access Trail, Norway Bluff, Piscataquis County, Maine*. Prepared for Patriot Towers, Inc. by Northeast Archaeology Research Center, Inc., Farmington, Maine.

Loftus, Sarah E., Robert N. Bartone and Hutch McPheters

2020 *Archaeological Phase I Survey of the Proposed Lunksoos Tent Sites Project, MHPC #1054-10, T3R7, Penobscot County, Maine*. Prepared for The Friends of Katahdin Woods & Waters by Northeast Archaeology Research Center, Inc., Farmington, Maine.

Maine Forest Service

2000 *Biophysical Regions of Maine*. Maine Department of Conservation.

Maine Historic Preservation Commission

1992 *Contract Archaeology Guidelines*. Manuscript on file at the MHPC. Augusta, Maine.

Maine State Legislature

1870, 1878, 1879, 1880 *Acts and Resolves of the Legislature of the State of Maine*. Sprague and Son, Printers to the State. Augusta, Maine.

McMahon, Janet S.

1990 *The Biophysical Regions of Maine: Patterns in the Landscape and Vegetation*. M.S. Thesis, University of Maine, Orono, Maine.

Neuman, Robert B.

1967 *Bedrock geology of the Shin Pond and Stacyville Quadrangles, Penobscot County, Maine*. Geological Survey Professional Paper 524-1.

Newman, William A.

1981 *Reconnaissance Surficial Geology of the Island Falls Quadrangle, Maine*. Open File No. 81-38. Maine Geological Survey, Augusta.

Office of the State Auditor

2015 *Unorganized Territory, Fiscal Year 2013 Annual Report*. Updated February 2, 2015. Electronic resource: <https://www.maine.gov/audit/documents/2013utreport.pdf>. Accessed 2020.

- Osberg, P.H., A.M. Hussey, and G.M. Boone  
1985 *Bedrock Geologic Map of Maine*. Maine Geological Survey, Augusta.
- Petersen, James B.  
1995 Preceramic Archaeological Manifestations in the Far Northeast: A Review of Current Research. *Archaeology of Eastern North America* 23: 207–230.
- Spiess, Arthur, and Leith Smith  
2016 *Predictive Models for Maine Prehistoric Sites*. On file at the MHPC. Maine Historic Preservation Commission.
- Starkey, Glenn Wendell  
1947 *Maine*. Silver Burdett Company, New York.
- Stuart, J. H.  
1894 *Stuart's Maps of the Timber Lands of Maine: No. 4*. J. H. Stuart & Co. Houlton, Maine.
- Thoreau, Henry David  
1864 *The Maine Woods*. Ticknor and Fields, Boston.
- USDA  
2020 *NRCS Web Soil Survey*. Electronic Source, <http://websoilsurvey.nrcs.usda.gov>. Accessed 2020.
- U.S. Geological Survey  
2012 *National Hydrography Dataset high-resolution flowline data*. The National Map Archived 2012 04-05.
- Varney, George Jones  
1881 *A Gazetteer of the State of Maine*. B.B. Russell, Boston.
- Walling, Henry F.  
1859 *Topographical Map of the County of Penobscot, Maine*. Lee & Marsh, New York.
- Williams, Chase & Co.  
1882 *History of Penobscot County, Maine, with illustrations and biographical sketches*. Cleveland, Ohio.



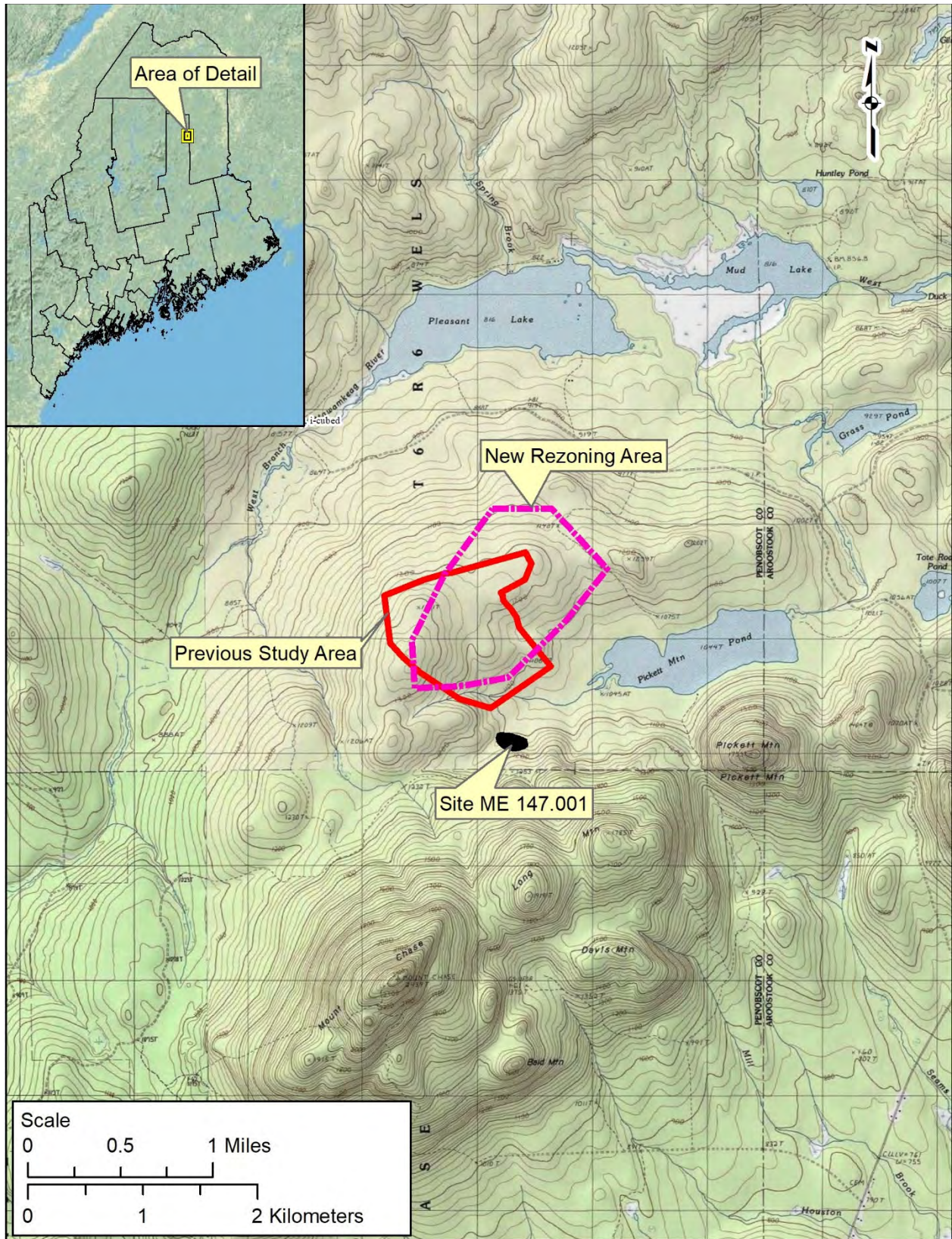

Figure 1. Topographic map showing the location of the proposed Pickett Mountain Mine Project, T6R6 WELS, Penobscot County, Maine.



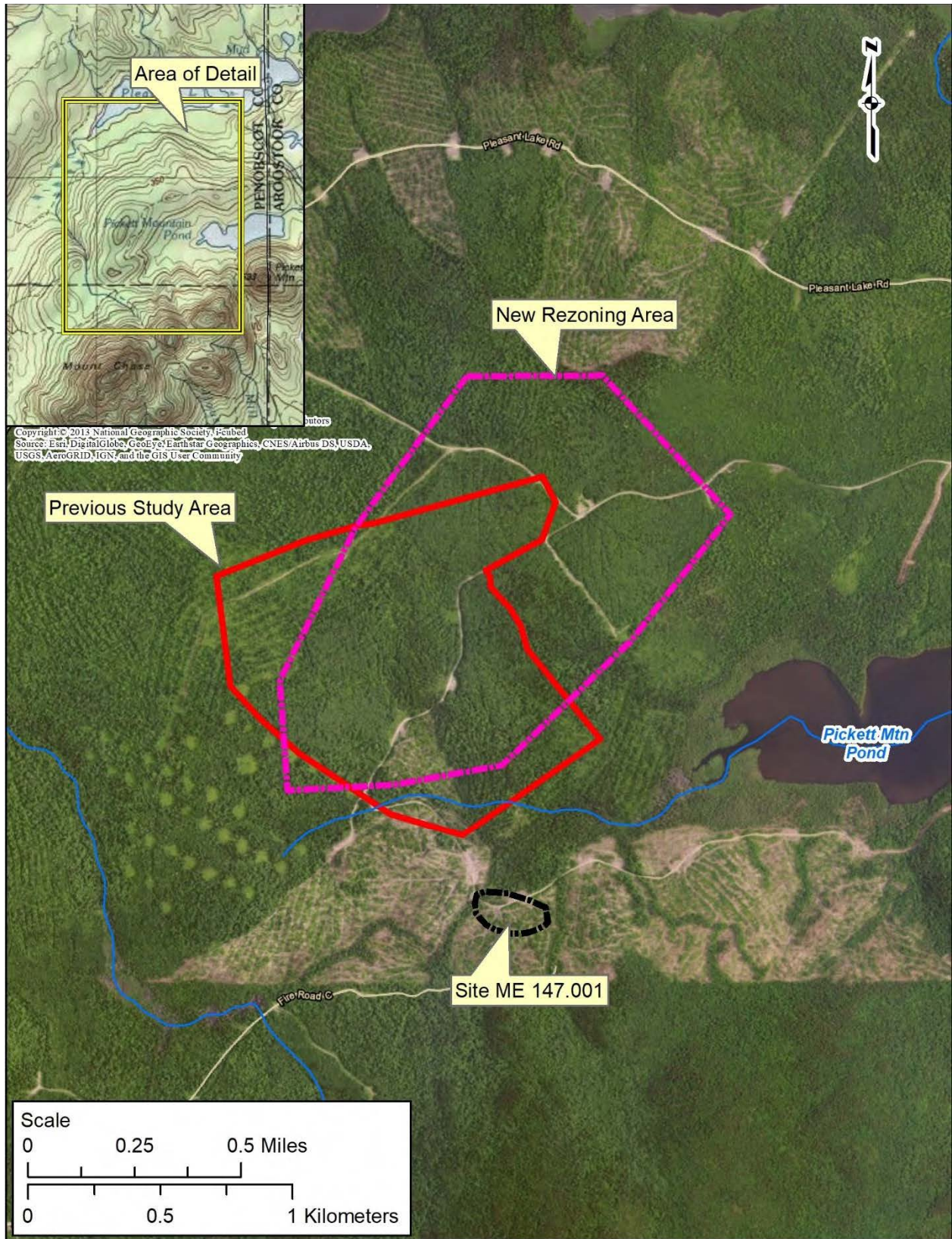

Figure 2. Aerial photograph showing the location of the proposed Pickett Mountain Mine Project, T6R6 WELS, Penobscot County, Maine.



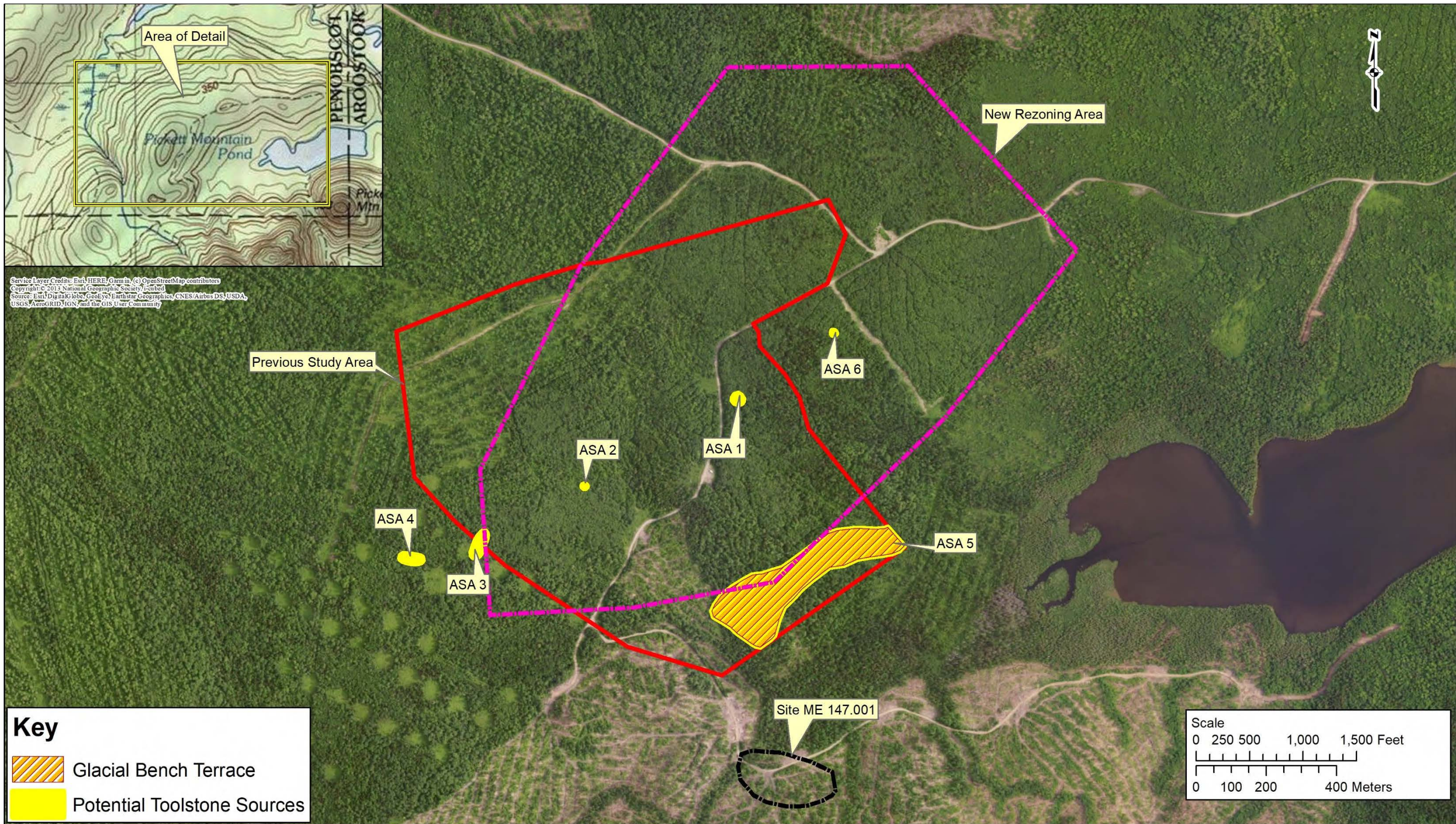

Figure 3. Aerial photograph showing the location of defined archaeologically sensitive areas (ASAs) within the proposed Pickett Mountain Mine Project, T6R6 WELS, Penobscot County, Maine. Note also the location of previously identified Native American site 147.001.



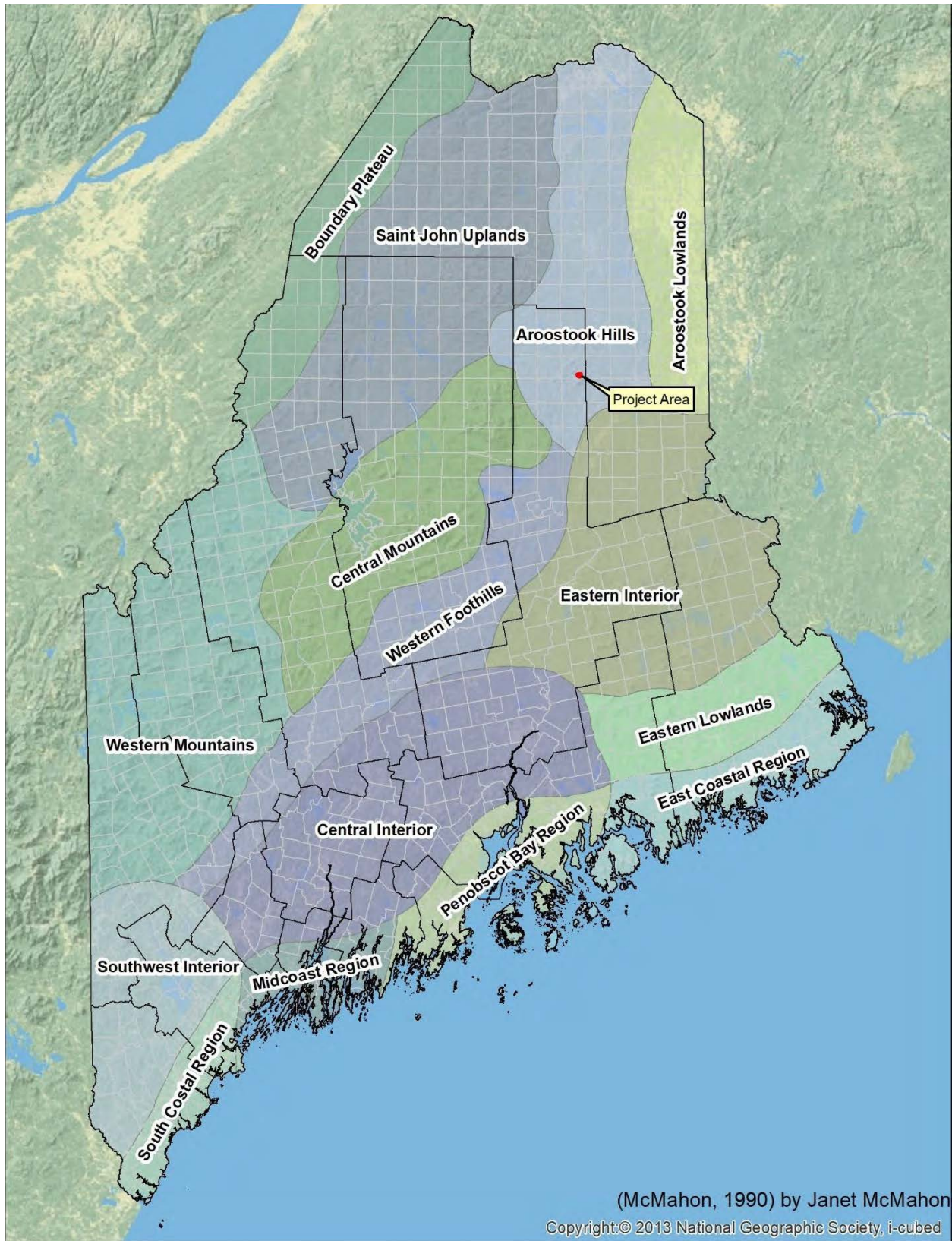

Figure 4. Map of the Maine biophysical regions showing location of the proposed Pickett Mountain Mine Project, T6R6 WELS, Penobscot County, Maine.



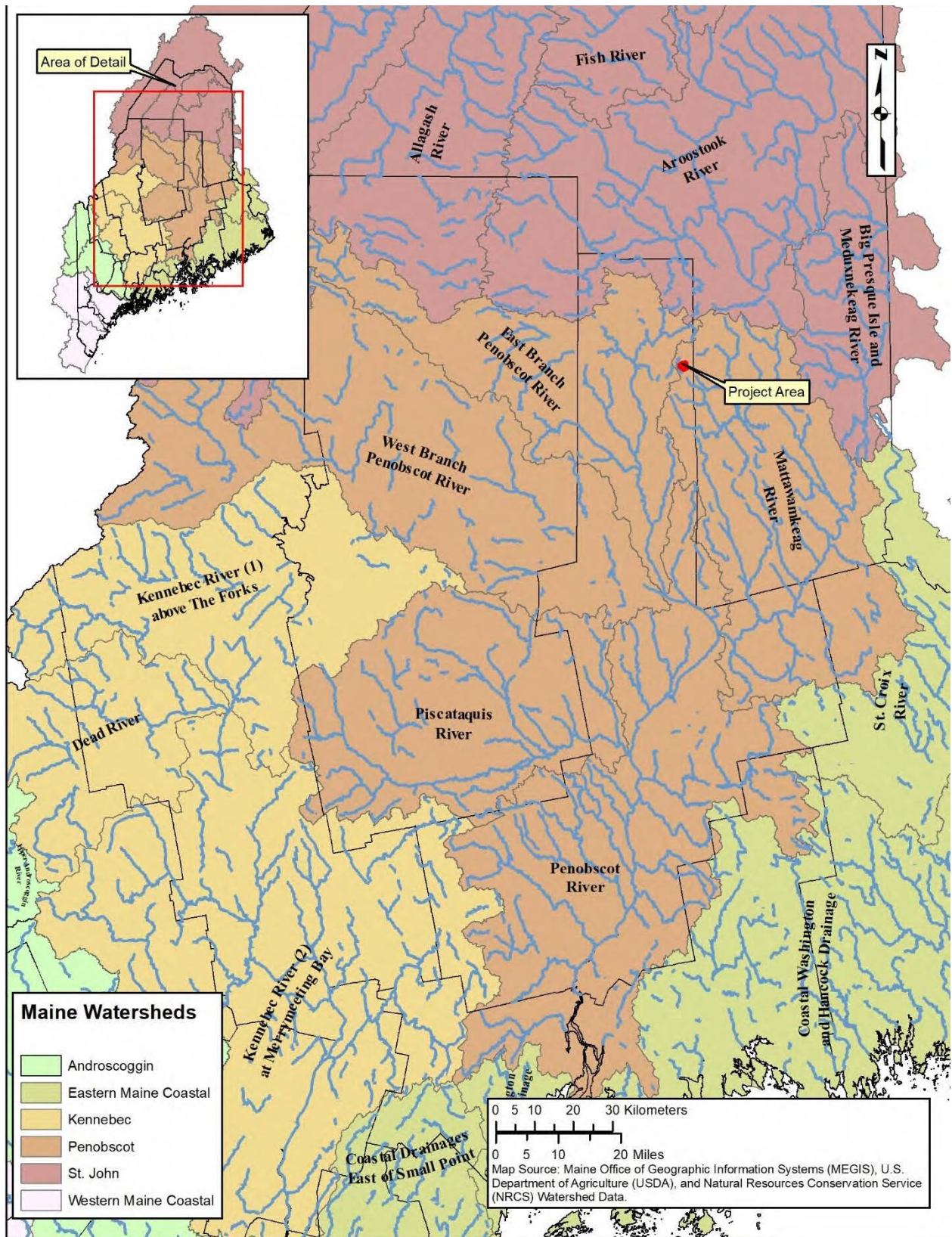

Figure 5. Regional watershed map showing the location of the proposed Pickett Mountain Mine Project, T6R6 WELS, Penobscot County, Maine.



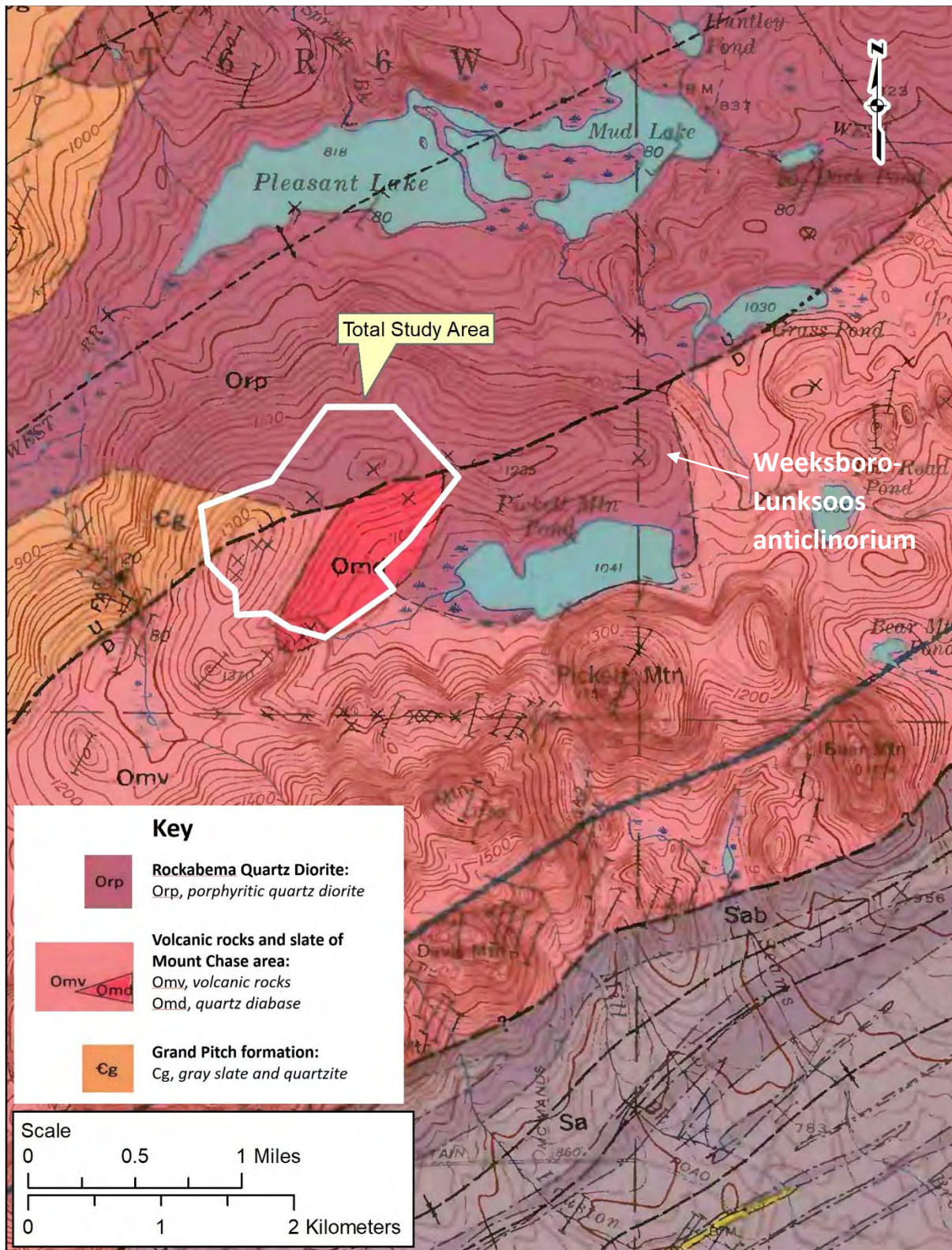

Figure 6. Section of the Ekren and Frischkneck 1967 bedrock geologic map of the Island Falls quadrangle, showing the location of the proposed Pickett Mountain Mine Project, T6R6 WELS, Penobscot County, Maine.



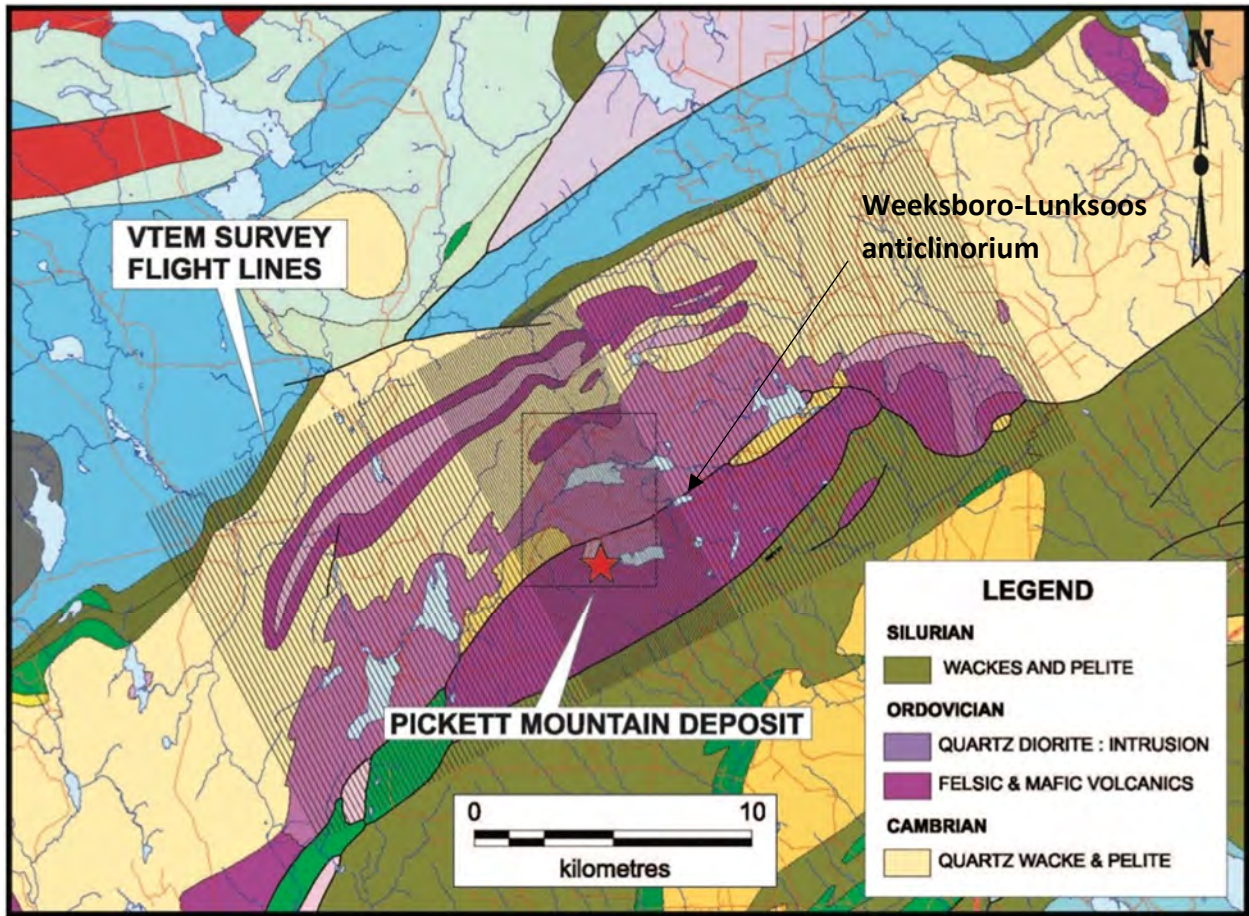

Figure 7. Wolfden map of the Pickett Mountain area of exploration, 2019, showing the generalized geology of the proposed Pickett Mountain Mine Project, T6R6 WELS, Penobscot County, Maine, and surrounding area.

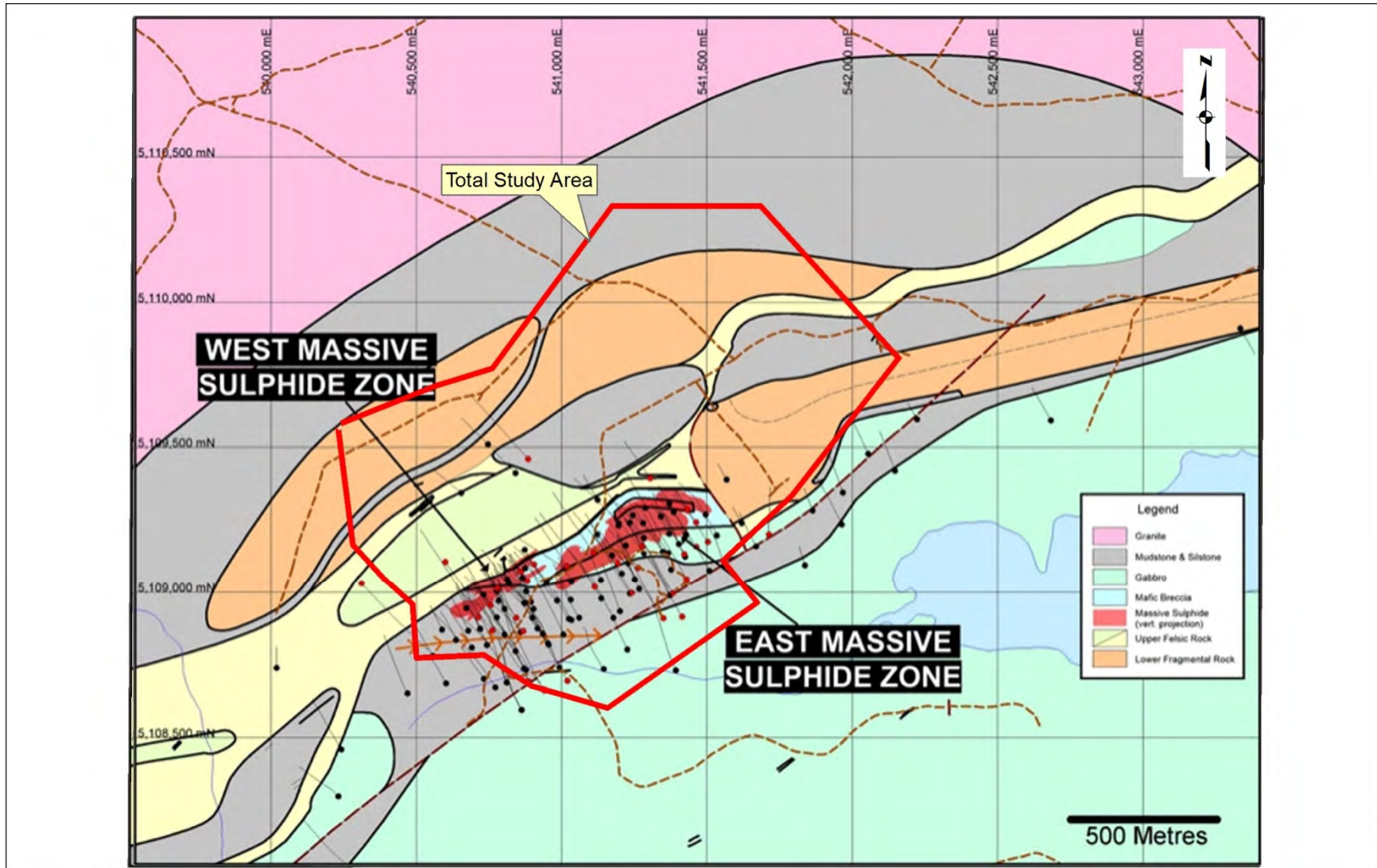

Figure 8. Wolfden geological plan of the Pickett Mountain area of exploration, 2019, showing the geology of the proposed Pickett Mountain Mine Project, T6R6 WELS, Penobscot County, Maine. The lines/dots mark boring locations.



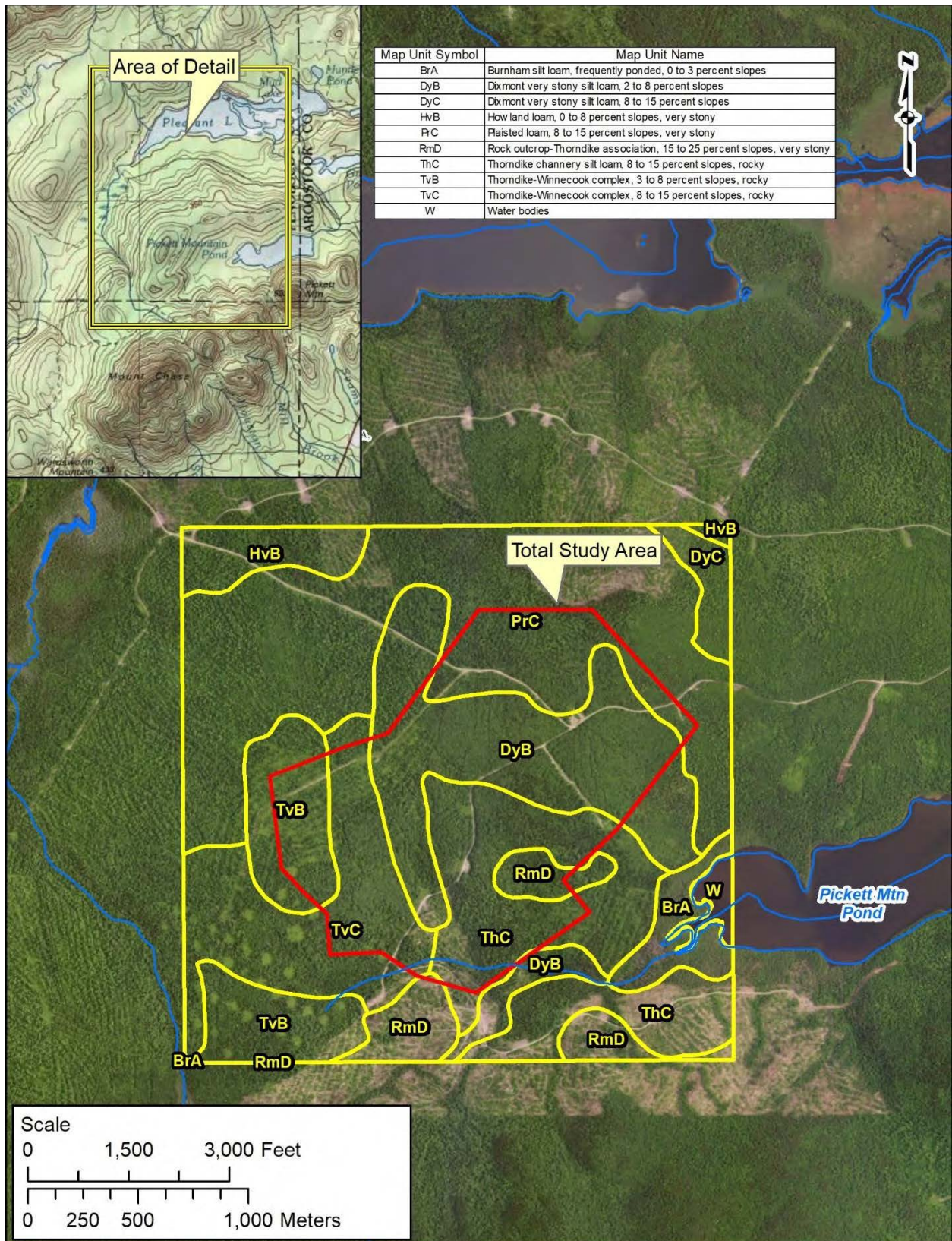

Figure 9. USDA Soils map of the proposed Pickett Mountain Mine Project, T6R6 WELS, Penobscot County, Maine.



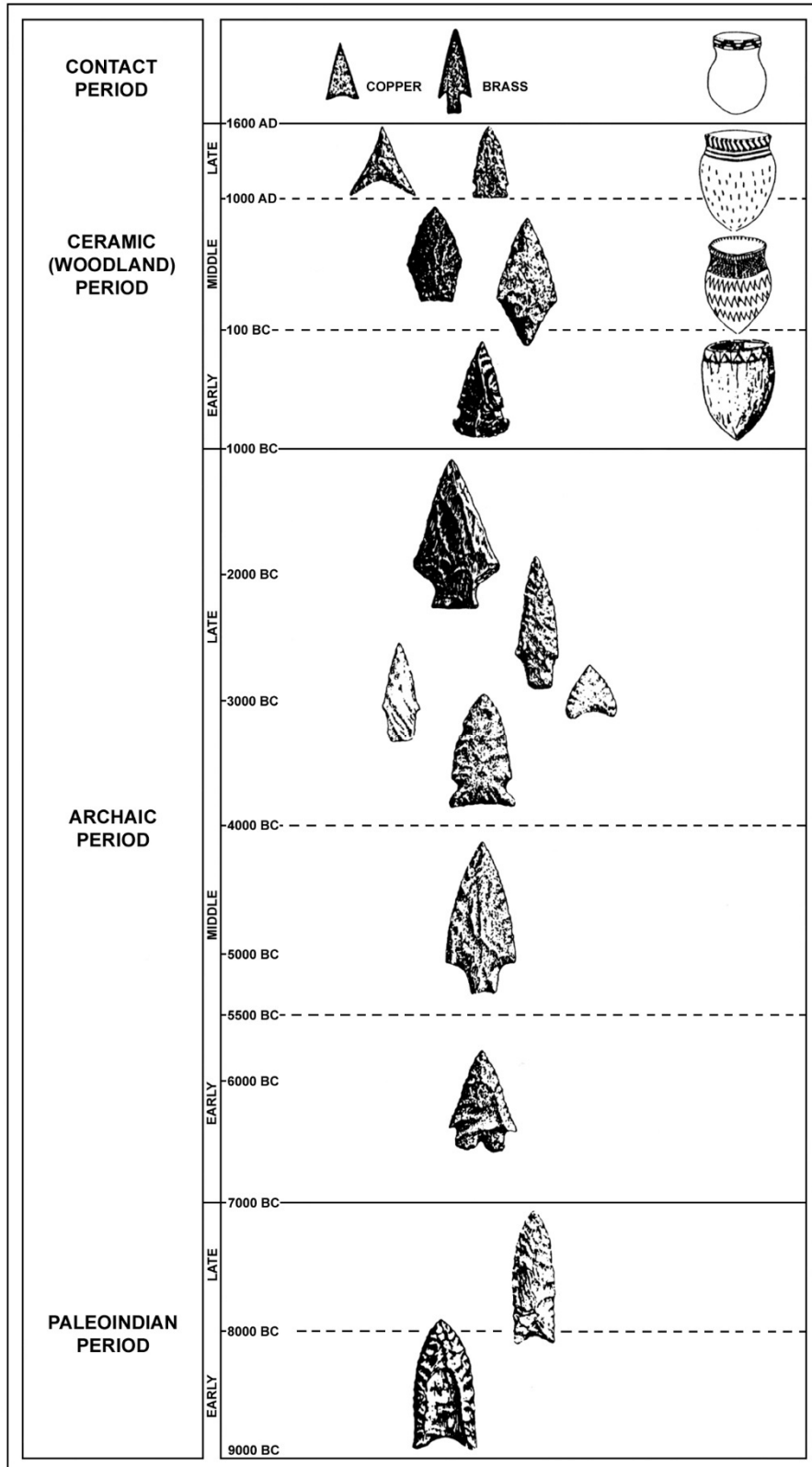

Figure 10. Timeline showing the major time periods of Native American history for Maine and the broader region.

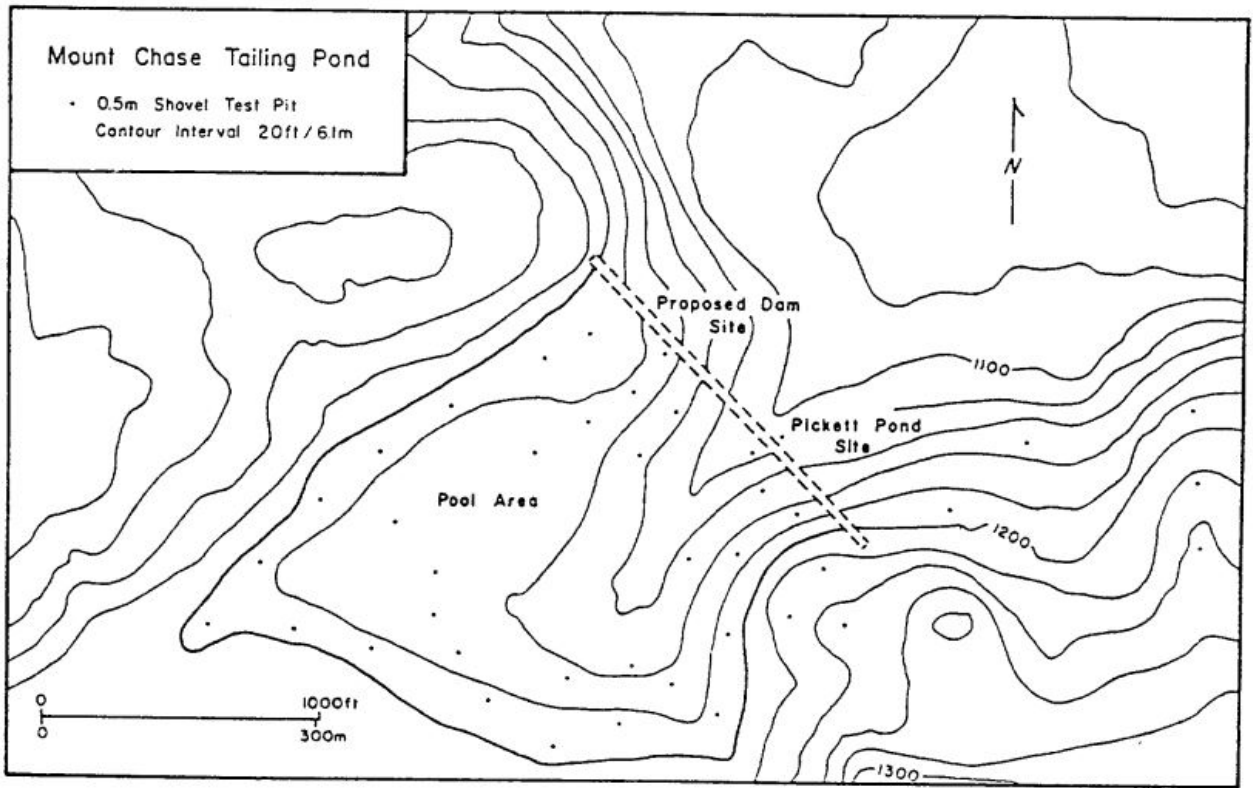

Figure 11. Map of tailing pond area showing location of previously identified site 147.001 (the Pickett Pond Site). From Bonnicksen et al. 1984:7, Figure 3.

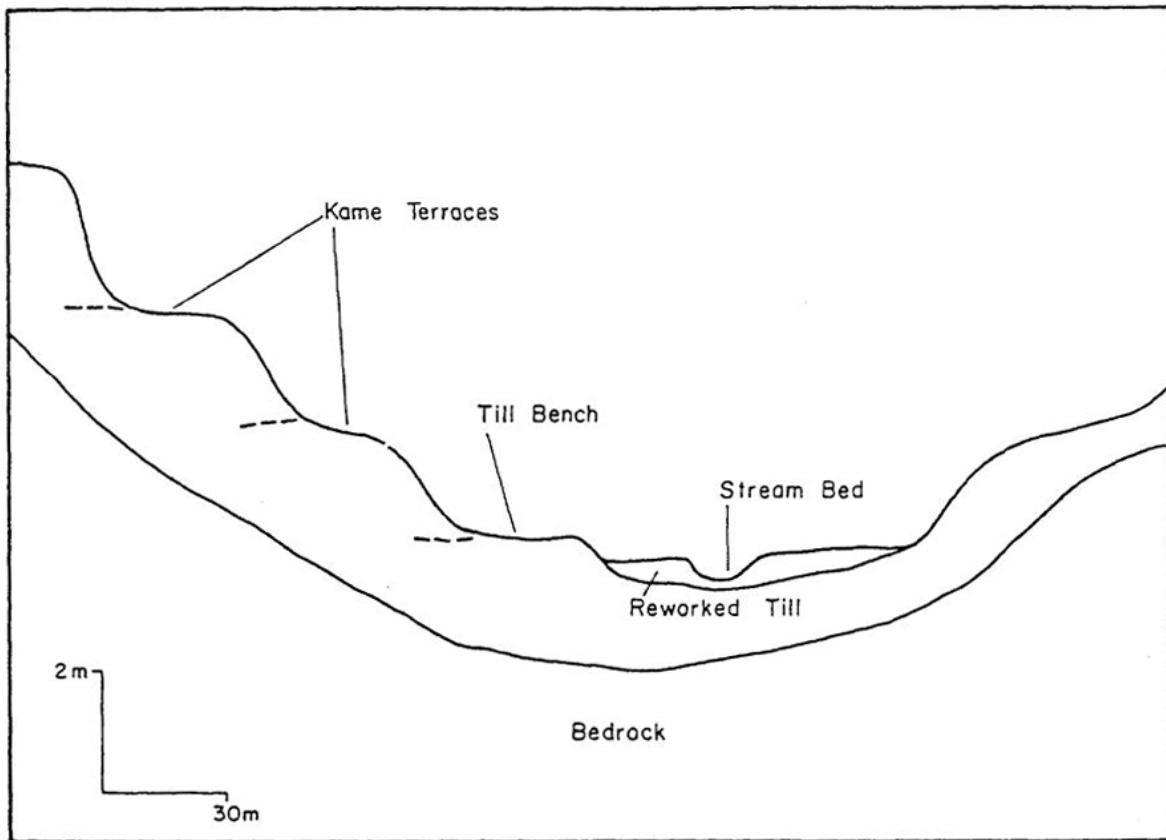

Figure 12. Profile sketch map of Pickett Pond basin surficial geology showing postglacial landforms. From Bonnicksen et al. 1984:6 Figure 2.



Figure 13. Section of the Walling 1859 map of Penobscot County showing the location of the proposed Pickett Mountain Mine Project, T6R6 WELS, Penobscot County, Maine.



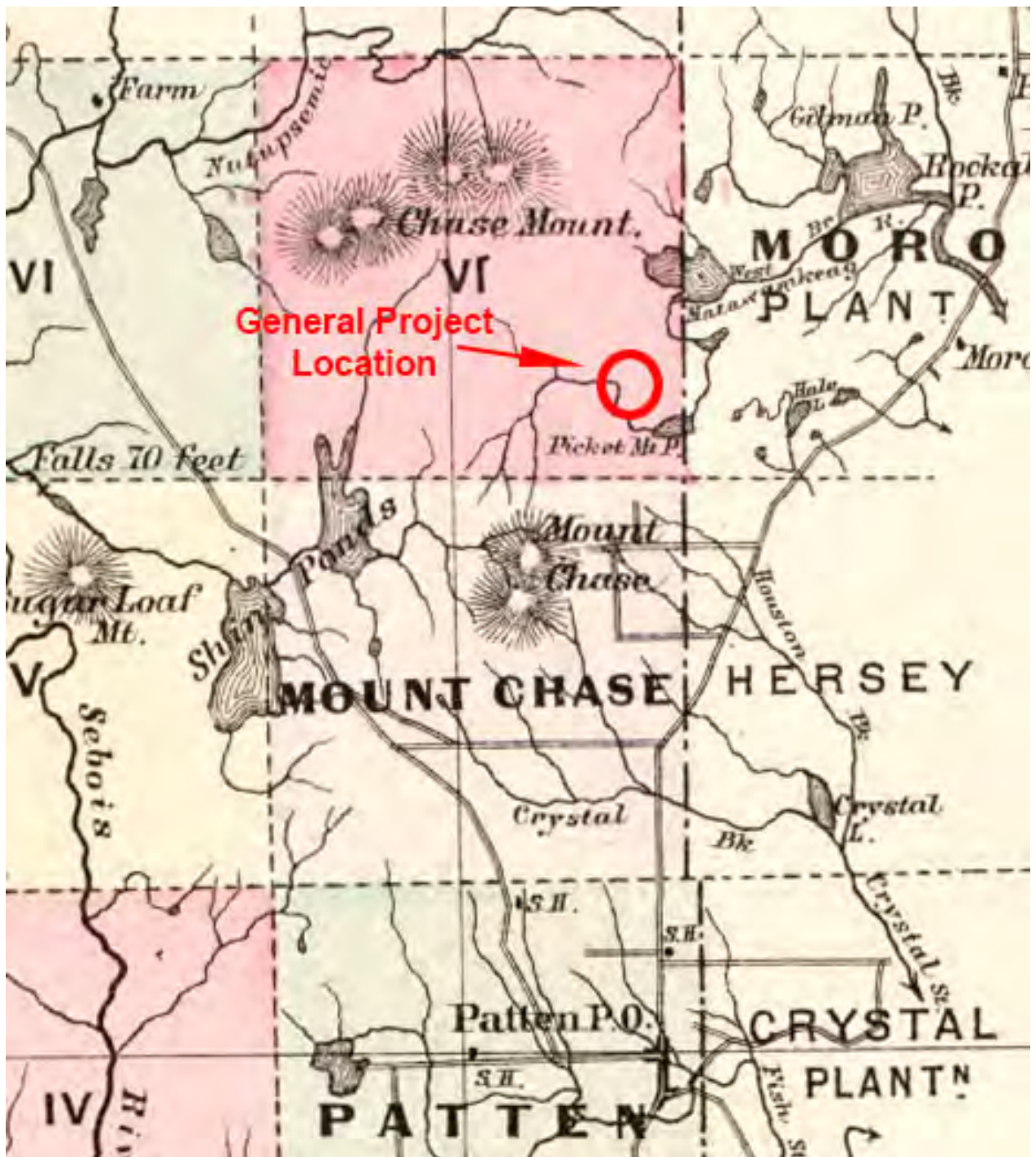

Figure 14. Section of the Colby 1885 map of Penobscot County showing the location of the proposed Pickett Mountain Mine Project, T6R6 WELS, Penobscot County, Maine.

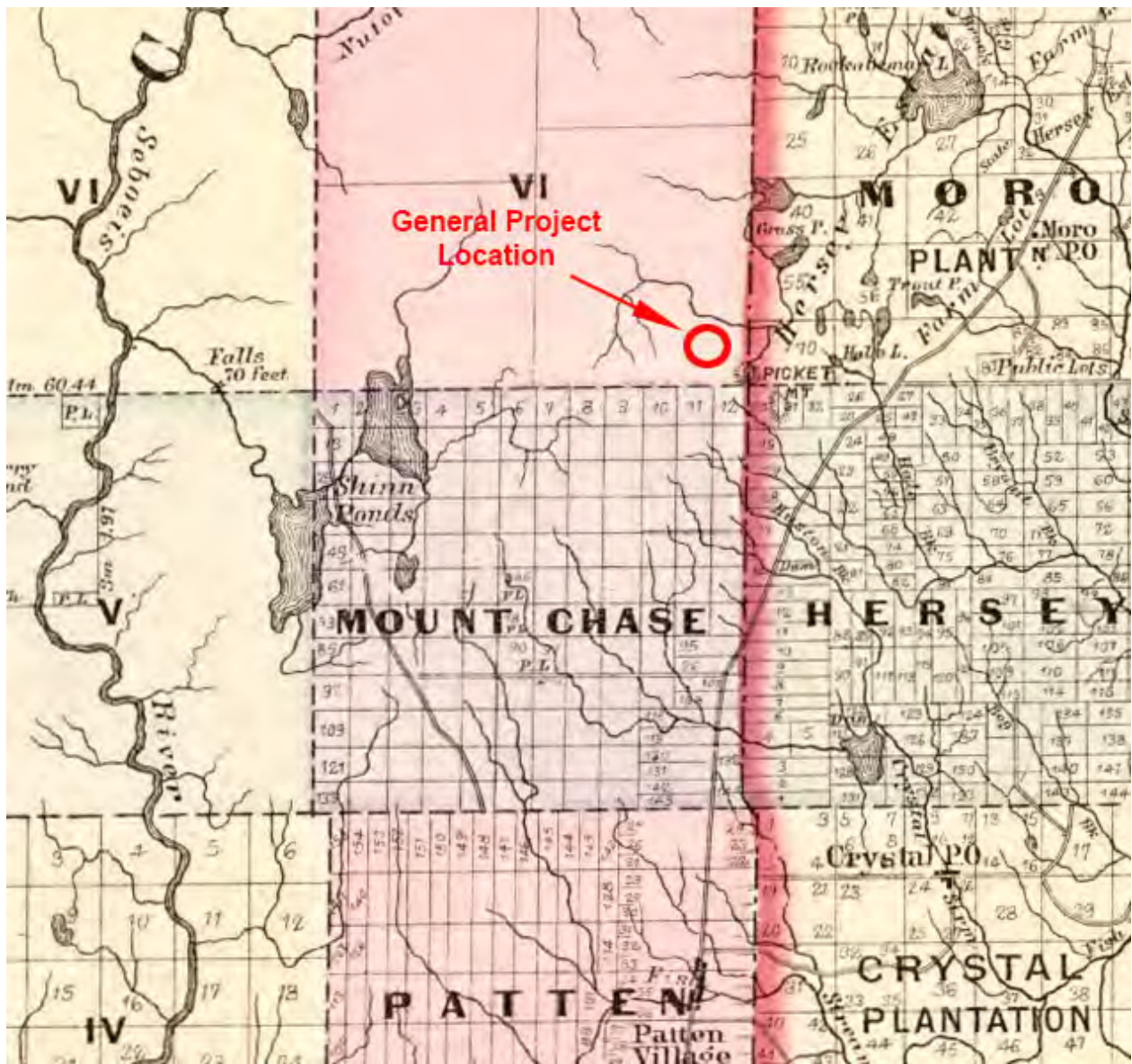

Figure 15. Section of the Stuart 1894 map of the Timber Lands of Maine showing the location of the proposed Pickett Mountain Mine Project, T6R6 WELS, Penobscot County, Maine.



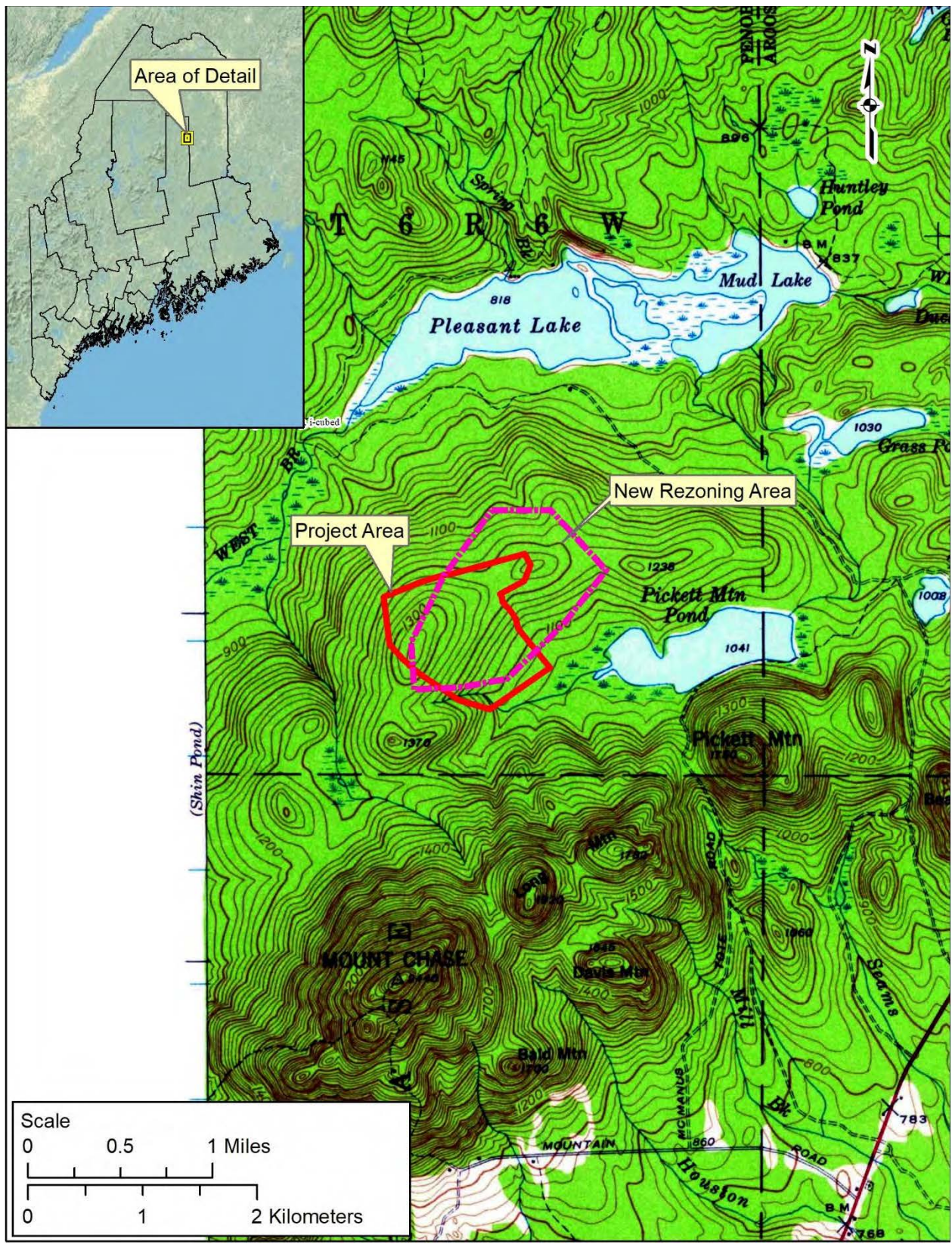

Figure 16. 1940 topographic map showing the location of the proposed Pickett Mountain Mine Project, T6R6 WELS, Penobscot County, Maine. Note tote road passing to the north of project area and structure on tote road near Pleasant Lake.





Figure 17. View southeast of skidder trail within the proposed Pickett Mountain Mine Project, T6R6 WELS, Penobscot County, Maine. Pickett Mountain is visible in the background. The photographer is standing on the hill in the northwest portion of the project area in the vicinity of ASA 3.





Figure 18. View north towards the proposed Pickett Mountain Mine Project, T6R6 WELS, Penobscot County, Maine. The photographer is standing in the approximate location of previously identified site 147.001 looking towards ASA 5. The thick undergrowth in the southern portion of the project area is clearly visible. This thick vegetation also denotes the location of wetland areas at the head of Pickett Mountain Pond.





Figure 19. View south of Wolfden geologists Don Dudek and John Breedlove at lithic outcrop ASA 1 in the eastern portion of the proposed Pickett Mountain Mine Project, T6R6 WELS, Penobscot County, Maine.



Figure 20. Lithic outcrop at ASA 1 in the eastern portion of the proposed Pickett Mountain Mine Project, T6R6 WELS, Penobscot County, Maine.





Figure 21. Sample from lithic outcrop at ASA 1 in the eastern portion of the proposed Pickett Mountain Mine Project, T6R6 WELS, Penobscot County, Maine.





Figure 22. View northwest of lithic outcrop at ASA 2 in the central portion of the proposed Pickett Mountain Mine Project, T6R6 WELS, Penobscot County, Maine.





Figure 23. Lithic outcrop at ASA 2 in the central portion of the proposed Pickett Mountain Mine Project, T6R6 WELS, Penobscot County, Maine.





Figure 24. Samples from lithic outcrop at ASA 2 in the central portion of the proposed Pickett Mountain Mine Project, T6R6 WELS, Penobscot County, Maine.





Figure 25. View west of part of lithic outcrop ASA 3 in the western portion of the proposed Pickett Mountain Mine Project, T6R6 WELS, Penobscot County, Maine.



Figure 26. View east of part of lithic outcrop ASA 3 in the western portion of the proposed Pickett Mountain Mine Project, T6R6 WELS, Penobscot County, Maine.





Figure 27. Samples from lithic outcrop at ASA 3 in the western portion of the proposed Pickett Mountain Mine Project, T6R6 WELS, Penobscot County, Maine. Note how well this material flakes using a geological hammer.





Figure 28. View northwest of lithic outcrop ASA 4, located outside of the western edge of the proposed Pickett Mountain Mine Project, T6R6 WELS, Penobscot County, Maine.





Figure 29. Lithic outcrop ASA 4, located outside of the western edge of the proposed Pickett Mountain Mine Project, T6R6 WELS, Penobscot County, Maine.



Figure 30. Sample of lithic outcrop in ASA 4, located outside of the western edge of the proposed Pickett Mountain Mine Project, T6R6 WELS, Penobscot County, Maine.





Figure 31. Lithic outcrop at ASA 6 in the central portion of the proposed Pickett Mountain Mine Project, T6R6 WELS, Penobscot County, Maine. Note that the lower rock seam appears to be an intact outcrop while the top appears to have been flipped or moved by heavy machinery.



Figure 32. Sample of lithic outcrop in ASA 6, located outside of the western edge of the proposed Pickett Mountain Mine Project, T6R6 WELS, Penobscot County, Maine.





Figure 33. Poor quality, reddish colored chert seam in the eastern portion of the proposed Pickett Mountain Mine Project, T6R6 WELS, Penobscot County, Maine. This chert was identified approximately 100 m south of ASA 1 (location marked on GPS with yellow dot).





Figure 34. Sample of poor quality, reddish colored chert seam in the eastern portion of the proposed Pickett Mountain Mine Project, T6R6 WELS, Penobscot County, Maine. This chert was identified approximately 100 m south of ASA 1.



Figure 35. Chert cobble, likely Munsungan material, recovered from glacial till in the vicinity of ASA 1 in the eastern portion of the proposed Pickett Mountain Mine Project, T6R6 WELS, Penobscot County, Maine (location marked on GPS with yellow dot).





Figure 36. Chert cobbles, likely Munsungan material, recovered from glacial till in the southwestern corner of the proposed Pickett Mountain Mine Project, T6R6 WELS, Penobscot County, Maine (location marked on GPS with yellow dot).





Figure 37. View northwest of gravel track in southwestern corner of the proposed Pickett Mountain Mine Project, T6R6 WELS, Penobscot County, Maine. The Pickett Mountain Pond stream is within the bushes at the right side of the photograph.





Figure 38. View east of level till bench landform in southeast corner of the proposed Pickett Mountain Mine Project, T6R6 WELS, Penobscot County, Maine. Note Wolfden coring location at left of photograph (orange marker).



Figure 39. View south of level landform in southeast corner of the proposed Pickett Mountain Mine Project, T6R6 WELS, Penobscot County, Maine. Note wetland beyond.

STATE OF MAINE  
DEPARTMENT OF AGRICULTURE, CONSERVATION & FORESTRY  
LAND USE PLANNING COMMISSION

IN THE MATTER OF	)	Pre-Filed Direct Testimony of Jeremy
REZONING PETITION ZP 779A	)	Ouellette on Behalf of Wolfden Mt.
WOLFDEN MT. CHASE, LLC	)	Chase, LLC

On behalf of Wolfden Mt. Chase, LLC (“Wolfden”), Jeremy Ouellette is submitting this pre-filed direct testimony in support of ZP 779A.

**I. QUALIFICATIONS AND EXPERIENCE**

I am the Vice President of Project Development for Wolfden Mt. Chase, LLC (“Wolfden”). I am a licensed professional engineer registered with the Association of Professional Engineers of Nova Scotia, license number 12710, and I hold a Bachelor of Engineering Degree with a Major in Mineral Resource Engineering from Dalhousie University in Nova Scotia, Canada, Ontario. I have completed Underground Full Common Core Training, which is a Canadian nationally recognized miner training program, and am a qualified person under National Instrument NI 43-101.

Prior to joining Wolfden in May 2019, I worked for Trevali Mining Corporation (“Trevali”) for approximately 8 years. As part of my tenure, I was a Senior Mine/Project Engineer and assistant Mine Superintendent at the Halfmile mine in New Brunswick. My duties also included Mine Superintendent, Mine Operations, Technical Superintendent, and ultimately Superintendent of Projects. My experience with Trevali included all phases of permitting, mine design, planning, and the construction/execution of mining projects. This included establishing programs and reporting structures that ensured compliance with strict regulatory standards and requirements. I also established and managed a team that designed and operated a green field mining project that operated in compliance with strict environmental standards. I was part of a

team that designed and operated the Caribou Mine, which had significant pre-existing environmental liabilities and was able to ensure that when the mine was re-started, it was in compliance with the updated environmental laws and regulations. As part of this re-start of the Caribou Mine, the Province of New Brunswick retained the previous environmental liabilities and Trevali committed to remediating, where possible, some of those sites.

My duties have also included working as part of a larger team that established a workforce training program and as one of the principal contact persons with the local and regional communities and organizations, the government, and First Nations.

The Halfmile mine is a good analog to the proposed Pickett Project. It is a small underground mine with a portal and ramp access that operated at 2,000 tonnes per day. The ore deposits occur in a similar package (age) of rocks that extends from New Brunswick into Maine, and the primary metals from the mine included zinc, lead, copper, silver, and gold, similar to the Pickett deposit. Once removed the mined ore was transported off-site to an existing processing facility located 37 miles away. The mine operations included a water treatment facility that treated mine and surface water prior to discharge back into the environment through in-ground infiltration galleries. Importantly, the site is roughly 2,000 feet (600 meters) away from high-value salmon waters, and it was critical that operations did not adversely impact those waters and associated habitat. Ground water and surface waters, and salmon habitat were and are continuously monitored, and there has been no degradation of water quality from mine operations.

## **II. INVOLVEMENT WITH THE PICKETT PROJECT**

I joined Wolfden in 2019 as Vice President of Development to work on the Pickett Mountain Project. Before doing so, I evaluated the technical information on the deposit and the



feasibility of developing a project that will comply with Maine’s stringent mining laws. After that evaluation, I concluded that the deposit had significant economic value, and that it will support a state-of-the-art mine that meets the stringent requirements and costs of compliance of Maine law.

I have been responsible for all aspects of development of the Pickett Project. During the last five years, I have hired and worked with a range of experts to develop a conceptual mine plan designed to meet the requirements of the Maine Metallic Mineral Mining Act and the Chapter 200 regulations.<sup>1</sup> We have had numerous meetings with relevant governmental agencies to discuss the requirements of Chapter 200 and ensure that the design is consistent with those requirements. In addition, with the assistance of the team I manage, we have spent considerable time meeting with local and regional groups and various stakeholders in the region to discuss the Project.

### **III. PROJECT OVERVIEW**

The Pickett Mountain Project (“Project”) is a small footprint, state-of-the-art proposal to mine zinc, lead, copper, silver, and gold from a high-value deposit in T6 R6 WELS, Penobscot County, Maine. The Project is located approximately nine miles north of the organized town of Patten. Additional organized towns proximate to the Project include Hersey and Stacyville.

---

<sup>1</sup> See 38 M.R.S. §§ 490-LL to 490-TT; 06-096 C.M.R. ch. 200 (collectively “Maine’s mining law” or “Chapter 200”)

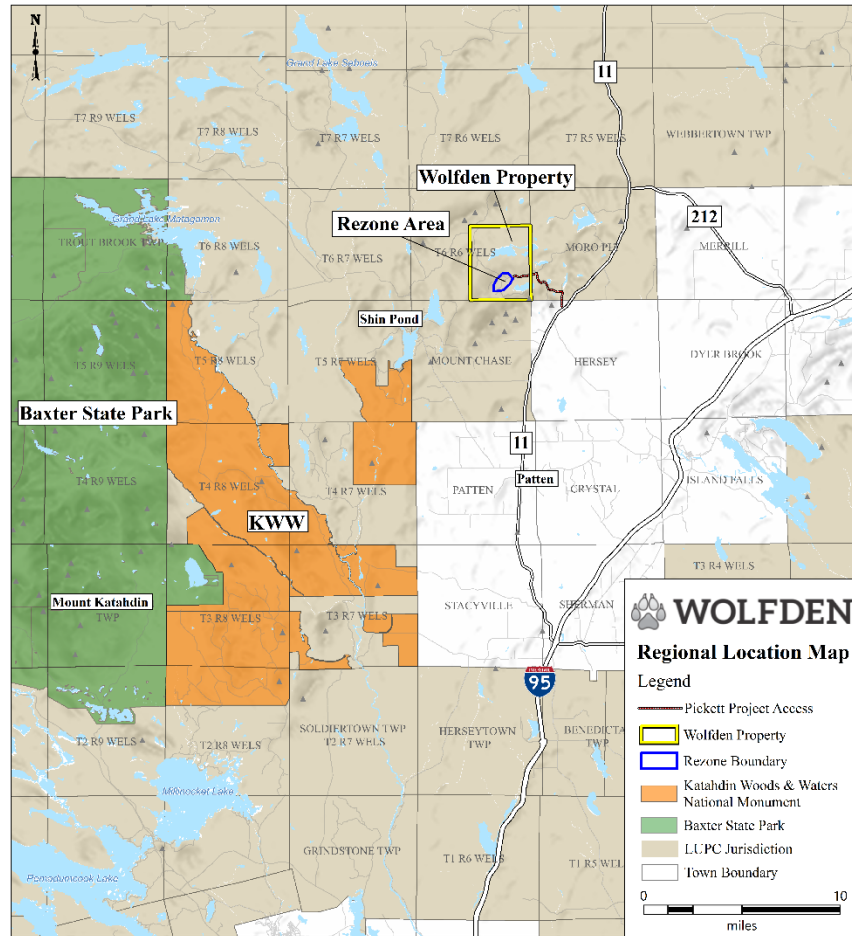

This Project is a revised version of a previously proposed rezoning application. It does not include the mine processing facilities (the concentrator and dry stack tailings management) within T6 R6, which will be located outside of LUPC jurisdiction. The D-PD rezoning criteria are premised on the existence of a particular natural feature or location that is present at the site and a determination that the site is the best reasonably available for the proposed use. The mine is dependent upon the existence of an economically viable mineral deposit, which is present in T6 R6. The processing facilities are not dependent on that feature, and therefore that use is less compatible with the purpose and intent of the D-PD rezoning criteria. Additionally, as discussed more fully below, Wolfden has been working with surrounding communities and believes that one or more of them may be more appropriate sites to host the processing facilities, which will



require approval and licensing through the Chapter 200 process in addition to any potential local permitting.

A. Maine's Metallic Mineral Mining Law

Maine has chosen not to enact a ban on mining but has instead enacted the most stringent mining law in North America. As a result, the only mining that can occur must be a state-of-the-art mine that is evaluated in an exacting and thorough regulatory process to ensure it is fully protective of the environment.<sup>2</sup>

It is important to differentiate the modern and strict mining regulations of Chapter 200 from what has occurred historically. Many people equate mining with open pit mines in which there is a large surface excavation, associated wet and often unlined tailings storage facilities, little to no water treatment with discharges directly into ponds, lakes, rivers and streams, and minimal closure reclamation or funding (a trust or bond). For example, the Callahan mine in Brooksville, Maine was an open pit mine that was excavated in a coastal wetland with wet and unlined tailings storage. Waste rock at Callahan Mine was stored in unlined piles adjacent to a saltmarsh and the wet tailings were stored in an unlined tailings facility where untreated water was allowed discharge into the estuary. Mining operations at Callahan ceased in 1972; which predates federal and state environmental regulations such as Clean Water Act in 1972 and Maine Natural Resources Protection Act in 1988. In addition, many of the mining elements included in the operations of Callahan Mine, such as mining in a coastal wetland, discharge of untreated wastewater, open pit mining, and wet pond tailings storage, are all prohibited under Chapter 200.<sup>3</sup>

---

<sup>2</sup> See 06-096 C.M.R. ch. 200.

<sup>3</sup> 06-096 C.M.R. ch. 200, § 1(B).

The Kerramerican mine in Blue Hill, Maine operated between the 1880's and the 1970s. Ore was excavated underneath a freshwater pond, the waste rock was stored in unlined piles adjacent to a freshwater pond, and two streams were dammed to construct tailings storage ponds. Water from these two tailings ponds was discharged to Carleton Stream. Storm-water runoff from the site eventually discharged to a pond and Carlton Stream. Similar to Callahan, the continual oxidation of the wet unlined tailings is the main contributor to the environmental impact. The Kerramerican mine is another example of historical mining in Maine that predates modern regulations and would not be allowed under Chapter 200.

There is no shortage of other mines that are held up as examples by the opponents of mining that involve improperly designed, operating, or closed open pit mines, wet tailings impoundments, inadequate water treatment systems, or failures in characterization and impact mitigation strategies and execution. These historical cases have driven the modernization of mining regulations and practices world-wide and were taken into account in enactment of Maine's mining law and promulgation of the Chapter 200 rules.

Maine's mining law now prohibits open pit mining, as well as wet tailings storage facilities.<sup>4</sup> Only underground mines are allowed, and the tailings must be dewatered, compacted and disposed of in an engineered double lined and fully sealed structure similar to modern landfills in Maine.<sup>5</sup> Maine law also requires that all water returned to the environment meet or exceed existing water quality at the site.<sup>6</sup> To ensure that occurs, the law requires extensive baseline environmental studies to characterize the deposit and the surrounding natural resources,

---

<sup>4</sup> 06-096 C.M.R. ch. 200, § 1(B)(4)-(5).

<sup>5</sup> Compare 06-096 C.M.R. ch. 200 § 21(A)(1)(a)-(b) (requiring a clay or compacted till bottom liner with a permeability of less than or equal to  $1 \times 10^{-6}$  cm/sec with a minimum 2-foot thickness and a high density polyethylene liner with a minimum thickness of 60 mils), with 06-096 C.M.R. ch. 401 § 2(D)(1)(a) (requiring at least a composite liner consisting of a geomembrane with a nominal thickness of 60 mils and a barrier soil layer).

<sup>6</sup> 06-096 C.M.R. ch. 586 § 1.

an environmental impact assessment, and intensive long-term environmental monitoring.<sup>7</sup> It is estimated that the baseline surveys (a minimum of two years of monitoring data is required) and subsequent DEP review and permitting process would take in excess of three years. Finally, unlike other forms of development, Maine's mining law includes comprehensive requirements related to financial assurance, including a requirement that funds be set aside and held in trust in an amount sufficient to address a host of contingencies, including catastrophic events and 100 years of potential remedial activities.<sup>8</sup> The form and the amount of the financial assurance must be reviewed by an independent third-party expert and approved by the DEP as part of Chapter 200, and the funding must be in place prior to the commencement of construction of any metallic mining project.

A summary of the application requirements for the Chapter 200 mining permit application, including the requirements for the baseline site characterization report, is attached as Exhibit A.

Maine's approach in Chapter 200 was to prevent those historical mine failures by establishing strict standards and requiring a comprehensive permitting process with significant public input and third-party review. Maine's environmental organizations, including NRCM and CLF, played a pivotal role in development of Maine's current mining law and celebrated its passage (and the subsequent DEP regulations) as protecting both citizens and the environment. As stated recently by CLF, the work by Maine's legislature and the DEP "has resulted in one of the best mining laws in the country, ensuring that any mining is done subject to the highest standards to protect surrounding natural resources and that the burden to meet those standards rests with those doing the mining." Similarly, NRCM stated that it "worked with the Legislature

---

<sup>7</sup> 06-096 C.M.R. ch. 200, § 22.

<sup>8</sup> 06-096 C.M.R. ch. 200, § 17.



to draft a common-sense bill that contained the toughest protections against mining pollution in the United States, . . . [and that the law] sets a new standard that could serve as a model for any state interested in protecting their citizens and environment from mining pollution.” See Exhibit B for statements from CLF and NRCM on Maine’s mining law. The Pickett Mountain Project is designed to meet the stringent requirements of Maine’s mining law and, importantly, will not receive a mining permit until it collects significantly more data and makes the required showing that it will meet each and every standard in Chapter 200.

**B. Project Description**

The application seeks to rezone approximately 374 acres (including a 400-foot undisturbed buffer around the site) of land owned by Wolfden and located within a larger contiguous tract of approximately 7,135 acres. A map of the proposed rezoning and surrounding area is included below.

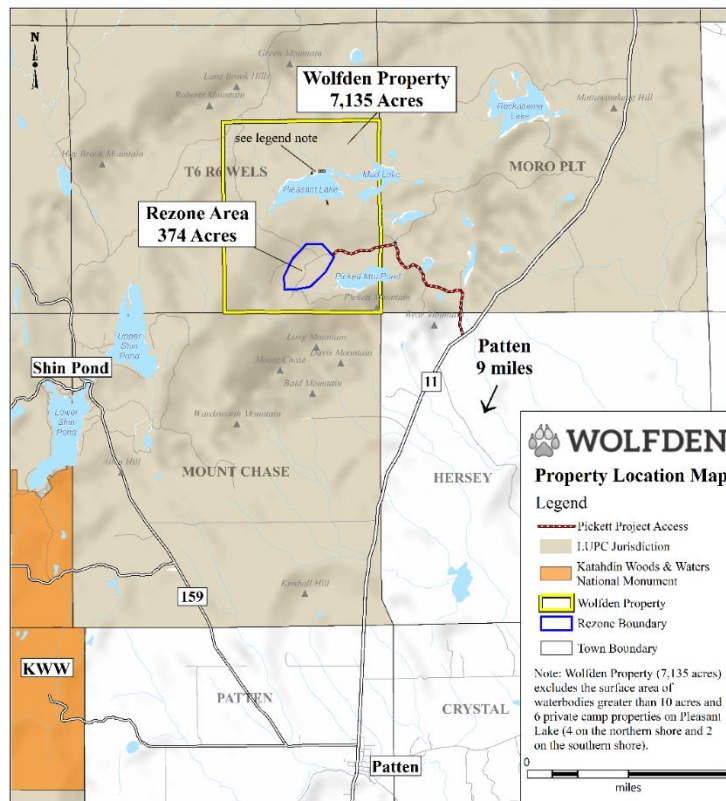

Within the rezone area there will be approximately 129 acres of clearing, including 47-acres that has been included to support a potential solar facility. The primary purpose of the solar facility would be to provide renewable power for the Project operations. A detailed image of the rezone area is shown on Figure 2-1 to the application and is attached as Exhibit C.

### 1. Project Infrastructure

The Project infrastructure is detailed on Figure 2-1 and listed on Table 6-1 of the Application. The bulk of the mining infrastructure is in the center of the rezone area and has been labelled and is referred to as the Mine Development Phase 1 area. It includes the mine access (portal) for a ramp to access the underground ore deposit and act as a haulage route for manpower, materials, rock, and services, including ventilation, electricity, water, and compressed air. The photograph below is an example of a similar mine portal.



Also located within the Phase I area are lined storage pads for ore and waste rock, water storage ponds (both pre-treatment and post-treatment), the water treatment facility, snow storage, and associated mining infrastructure and buildings. This area includes the main access road to the site, with parking and an office building.

There is an area on the southwest portion of the site, referred to as the Mine Development Phase II area, that includes an organics storage area, additional ore storage areas, and a headframe and hoist that will be developed approximately three years after commencement of operations to access the deeper ore. During the first three years of operation, waste rock and ore will be transported to the surface via the ramp and portal in the Mine Development Phase I area. After three years, a shaft, headframe, hoist, and conveyances will be installed in the Mine Development Phase II area and will be the primary conveyance of waste rock and ore to the surface.

The third area is the proposed solar field, which is located on the northern portion of the rezoned area. Each of these three areas is shown on the Figure below identified in Blue, Orange and Green respectively.

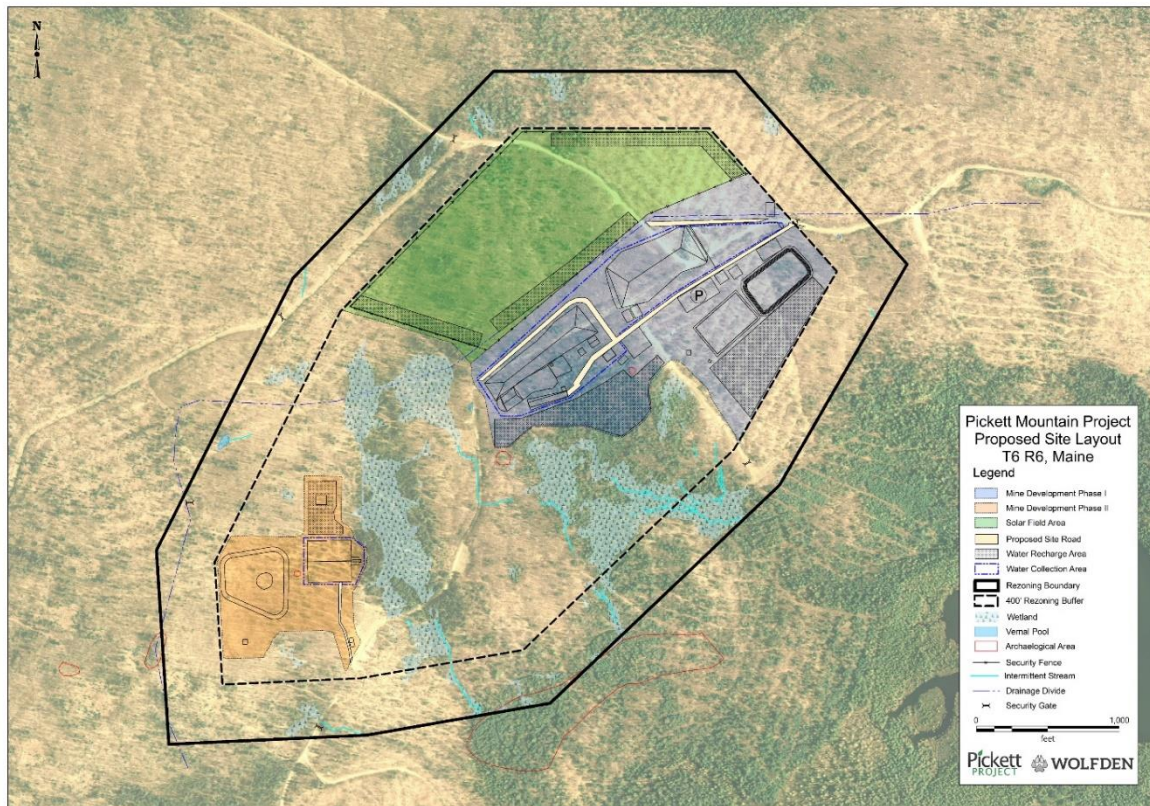



## 2. Excavation and Management of Ore and Waste Rock

During mine operations personnel will excavate the ore from underground via drilling and blasting into manageable sized fragments that can be loaded into underground trucks or into a skip and hauled or hoisted to the surface. A skip is a multiple tonne bucket raised and lowered by a steel rope or cable powered by a hoist. Mined ore will be stockpiled on engineered lined storage pads, referred to as Ore (Mill Feed) Storage Pads, until it is trucked off-site for processing. There is one located in each of the Mine Development Phase I and II areas. Waste rock (rock that is outside of the deposit) will be removed, temporarily stored on lined Waste Rock Storage Pads, and eventually transported back underground for use as backfill. Backfill is sometimes blended with cement as a binder and, along with off-site borrow sources of rock material, is used to fill the mine voids from where the ore was extracted. There is one Waste Rock Storage Pad in each of the two Mine Development Areas.

All of these storage pads will have engineered under pad liners designed to collect run-off, which will then be conveyed to the water storage ponds to be treated and returned to the environment as clean water. The full water treatment system is discussed in more detail in the Pre-Filed Direct Testimony of the Water Management Panel. It is a critical component of ensuring that the Project does not adversely impact water resources (including the flora and fauna) in the area.

The underground mining activities include construction of the primary ramp to access the underground deposit and lateral tunnels on each working level to connect the ramp to the ore deposit, as depicted in the schematics below.



## Ore extraction by ramp

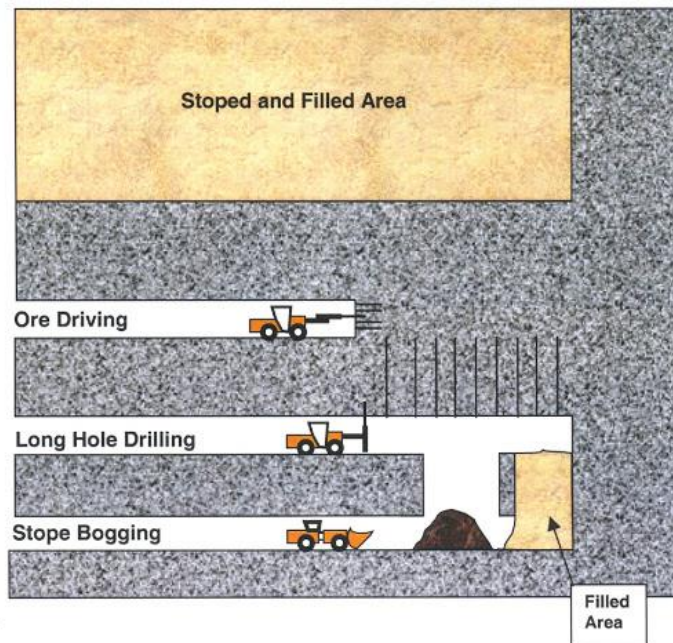
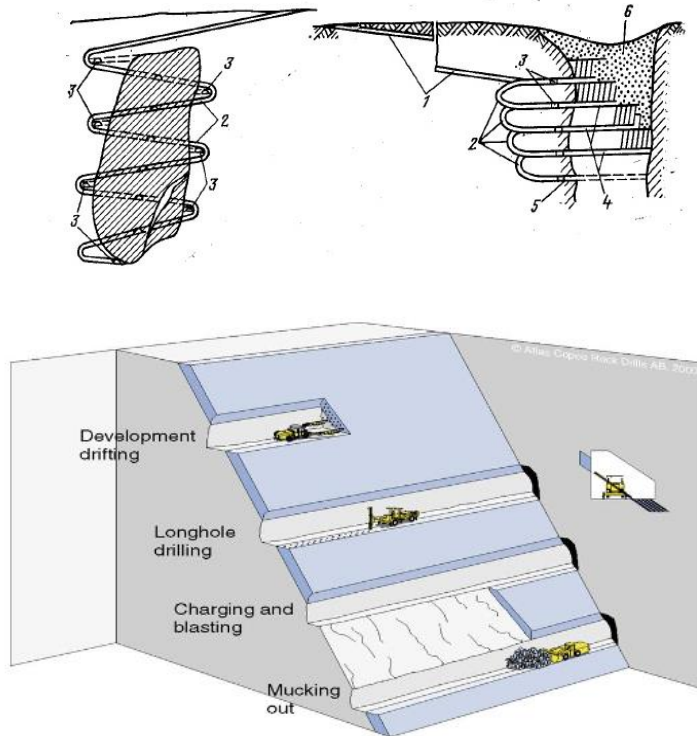

Removal of rock from a developed area is typically completed with a low-profile front-end loader, with rock then placed into a low-profile truck for haulage for further handling within

the mine. All mined ore will be crushed underground, and trucks will then transport the crushed ore and waste rock to the lined surface storage pads. The crushed ore is then loaded from the surface pads onto trucks and transported offsite to a concentrator.

Underground mining requires the use of process water to operate the equipment. Additionally, there is seepage of groundwater into the mine. Sumps will be used to collect both groundwater and process water and that water will be pumped out of the mine and stored in the Pre-Treatment Water Storage Pond. The majority of the mine water is recycled for use in the mine as process water; a small amount is returned to the environment after treatment.

### 3. Reclamation

The Project is expected to generate approximately 1,322 imperial tons (1,200 metric tonnes) of ore per day and has a projected duration of 10-15 years. Upon completion of mining activities, final reclamation will take place. The Chapter 200 regulations specify the reclamation standards, which include decommissioning of site buildings and structures, ground surface cleanup and contouring, spreading of subgrade overburden, topsoil and final capping material (vegetation and seeding), backfilling and bulkheading the underground openings, and long-term monitoring of water quality and site conditions as. After closure, the Chapter 200 regulations require ongoing monitoring, maintenance, inspection, and care of the site until the DEP determines that such monitoring is no longer necessary.<sup>9</sup> Funds for reclamation, closure, post-closure maintenance and monitoring as set aside and held in trust as part of the Chapter 200 financial assurance requirement.<sup>10</sup>

---

<sup>9</sup> 06-096 C.M.R. ch. 200, § 24(B)(3)

<sup>10</sup> 06-096 C.M.R. ch. 200, § 17(A)(1).

#### IV. STAKEHOLDER ENGAGEMENT

LUPC-issued guidance interpreting the Comprehensive Land Use Plan recognizes the increased emphasis placed on “[s]erving the regions in which the unorganized and deorganized areas are located,” and “[h]onoring the rights and participation of residents and property owners.”<sup>11</sup> A key component of my efforts on the Project has been to meet with people in the region to answer questions and provide accurate information. I realize that many people may not be familiar with what we are proposing or have misconceptions about the modern mining regulations and the standards this Project must meet. My focus has been to provide accurate information and create opportunities for meaningful engagement. To that end, we have held many sessions open to the public in the surrounding town halls and have been invited to many town hall public meetings. In addition, in 2022 we opened an office on the main street of Patten, to allow anyone an opportunity to ask questions about the Project in an informal way with as much detail as requested.

We also have instituted more formal processes for community engagement and education. For example, we have created a Community Advisory Committee (CAC). The committee members are representatives from the various towns surrounding the proposed project, including Hersey, Island Falls, Sherman, Patten, Moro Plantation, and Mount Chase. The CAC is welcoming other interested representatives to join. The meetings are typically held every two months and are scheduled in advance by the CAC. Records of the meetings are maintained, and the agenda is set in advance for each meeting. These are public meetings designed for informed discussion on topics recommended by the public and selected by the CAC. To date, there have been three public CAC meetings, most recently in August of 2023, and topics have

---

<sup>11</sup> Me. Land Use Planning Commission, *Guidance for Interpreting the 2010 Comprehensive Land Use Plan* at 2 (Oct. 5, 2012) (“CLUP Guidance”), attached as Exhibit D.

included an Overview of Wolfden and the Pickett Project; Project Geology and the Mining Method; and the LUPC Rezoning Process.

During the last several years, I have also worked one on one with municipal officials, local leaders, and residents in each of the surrounding communities to provide information on the Project and the permitting process. It is important to understand the local concerns so that we can be responsive to those concerns. These meetings and those of the CAC have been and will continue to be critical in achieving that goal. It is equally important for the communities to learn about the Project and to understand the steps in the permitting process. Attached as Exhibit E is a summary of key community meetings and events that Wolfden has hosted or participated in over the last several years to discuss the Project.

The surrounding towns have been engaged and deliberate in their approach to the Project, and the process that was followed by the town of Hersey is instructive. After preliminary discussions with town officials the Selectboard held more than seven meetings over the course of a year to learn about the Project and solicit feedback from residents. The DEP was asked by the Town to present at one of the meetings in order to provide an overview of the Chapter 200 regulations and permitting process as well as answer related questions and how it may pertain to the Pickett Project. Following this comprehensive process, the town voted to adopt an ordinance whose purpose was “to allow a mining project, or any related mine infrastructure, to be located in the Town of Hersey provided that the project satisfies all regulatory requirements and standards of Chapter 200.” A copy of the Hersey Ordinance and minutes is attached as Exhibit F. The ordinance established a review process to supplement the DEP Chapter 200 process and identified local standards that any such project would have to meet.



Similarly, the town of Patten convened numerous meetings to ensure that the residents there were well informed about Wolfden and the Project. The Town specifically invited NRCM to present at one of their meetings, which they did. Following their public meeting process, Patten voted at a special meeting on April 13, 2023, to authorize the Selectboard to sign a resolution in support of the Project. A copy of the Special Town Meeting Minutes is included as Exhibit G.

The towns of Sherman, Stacyville, and Moro Plantation passed resolutions that recognize the comprehensive requirements set forth in the Chapter 200 rules and support Wolfden proceeding to the Chapter 200 permitting process. Resolutions and documentation are included as Exhibits H, I, and J. Mount Chase considered a similar resolution, but with a split vote of 50% for and 50% opposed, the resolution did not pass.

Outreach to and consultation with the Maine tribes on this Project is important to us. In Canada, there is a formal and well-established process for engagement with First Nations, and we have worked successfully with them on previous projects. In early 2020, I reached out the Managing Director of the Maine Indian Tribal-State Commission (MITSC) and their board. After several attempts over the course of more than a year, I was able to have a zoom meeting to introduce Wolfden and the Project. The meeting included representatives from the Penobscot, Maliseet and Passamaquoddy tribes. NRCM also attended. Subsequent efforts to meet with the MITSC on the Project have not been successful.

In September 2022, prior to filing our application, we sent letters requesting information on any significant cultural or historical resources to the Passamaquoddy Tribe, the Mi'kmaq Nation, the Houlton Band of Maliseet Indians, and the Penobscot Nation. We also provided the Tribes with a copy of the Phase 0 archaeological study noted below. The Passamaquoddy THPO

submitted comments to LUPC, which are attached as Exhibit K. They requested an archeological survey of the Project footprint, including on any new road construction. As discussed in the Pre-Filed Direct Testimony of Gemma-Jayne Hudgell, Ph.D., Northeast Archeology Research Center did a Phase 0 Assessment of the Project footprint, including at selected locations along the access road that might require improvements. They will conduct a Phase 1 Survey of potentially archeologically sensitive areas that were identified during the Phase 0 Assessment. In our September letters, we also requested that the Tribes review the Phase I survey design when it is developed and participate in its implementation. Finally, we requested further review of the processing facility location once a site is chosen. We have not received formal feedback in response to the consultation letters other than from the Passamaquoddy THPO.

An important part of my work with stakeholders centers around the job and economic opportunities associated with the Project. The Commissions' Chapter 12 rules applicable to metallic mineral mining require consideration of socioeconomic impacts, and the Commission's CLUP Guidance specifically acknowledge the increased emphasis on "encouraging and facilitating regional economic viability."<sup>12</sup> Wolfden hired Stepwise Data Research to prepare a comprehensive socioeconomic analysis of the Project on the region's economy. As reflected in that report and the Pre-Filed Direct Testimony of Michael LeVert, the Project will result in a significant economic and fiscal contribution to the region.

To help ensure that those socioeconomic metrics are upheld, I have been working with education systems throughout Northeastern Maine in preparation for initiating a training course focused on mining and related activities. I have had initial discussions with NMCC, EMCC, as well as Region 2 and Region 3 vocational schools in Houlton and Lincoln, respectively.

---

<sup>12</sup> CLUP Guidance at 3.

Although no agreements have been put in place to date, we believe that preparation for these courses will take time and early communication is important. The course outline has been utilized successfully in New Brunswick and is focused on ensuring that the skillsets that exist in Maine such as equipment operators, mechanics, welders, millwrights, carpenters, electricians, amongst others, can be introduced to and trained for underground mine work.

Specifically, and as reflected in the chart below, Wolfden expects to hire 233 employees to work at the mine.

<b>Pickett Mine Employment Estimate</b>	
<b>Position</b>	<b># of Total Hires</b>
Mine Manager	1
Mine Superintendent	1
Technical Services Superintendent	1
Senior Engineer	1
Accountant	1
Engineer/Geologist Technicians	2
Warehouse Manager	1
Environment Coordinator	1
Medical Contract	1
Security Guard	4
Site Services	1
Underground Equipment Operator	32
Underground Mechanic	44
Underground Laborer	46
Underground Miner (Standard)	32
Underground Miner (Alimak)	20
Supervisor	8
<b>Total Wolfden Mine Employees</b>	<b>197</b>
Steady State Contract Employees	36
<b>Total Employees at Site</b>	<b>233</b>

## V. NEXT STEPS IN THE PROCESS

If rezoning is approved, Wolfden will finalize a location for the processing facilities and commence the baseline surveys required by Chapter 200. The required surveys include the following:

- Documentation of aquatic and terrestrial flora and fauna species;
- A water balance of the mining and affected area, including but not limited to consideration of precipitation, evapotranspiration, infiltration, runoff, surface and groundwater flow, hydraulic gradients, velocity, flowpaths, elevations, and groundwater/surface water interactions;
- An ambient water quality and monitoring plan and results that provide baseline water quality information for any potentially impacted surface or groundwater;
- Documentation of baseline climatological and meteorological conditions; documentation of all watersheds, groundwater basins and aquifers; and,
- A study documenting soils and other surficial deposits; and documentation of cultural, historical, and scenic resources.<sup>13</sup>

The workplan for those studies must be submitted to the DEP in advance and is subject to public review and comment.<sup>14</sup> In addition to the baseline surveys, Wolfden must include an Environmental Impact Assessment (EIA) as part of its mining application. The EIA must encompass the environmental, human health and safety, physical, cultural, and land use impacts of the project, as well as measures for mitigating significant impacts. The draft scoping document for the EIA must be prepared in advance and, like the baseline surveys, is subject to public review and comment as part of the DEP Chapter 200 process.<sup>15</sup>

In parallel to the baseline survey study work, Wolfden will commence the feasibility study work, which includes characterizing the deposit in greater detail and other work necessary

---

<sup>13</sup> 06-096 C.M.R. ch. 200, § 9(C) (requirement for baseline site characterization report); *see also* Exhibit A.

<sup>14</sup> 06-096 C.M.R. ch. 200, § 10(B).

<sup>15</sup> 06-096 C.M.R. ch. 200, § 10(C).



to develop the more detailed engineering designs, mine planning, processing, water treatment, closure and remediation.

Once Wolfden has completed the required pre-application work, it will file an application for a mining permit. That process requires an adjudicatory public hearing and includes requirements for county and municipal intervenor grants.<sup>16</sup> The chart below is a timeline showing the key steps that have occurred to date and future milestones.

### Pickett Project Next Steps

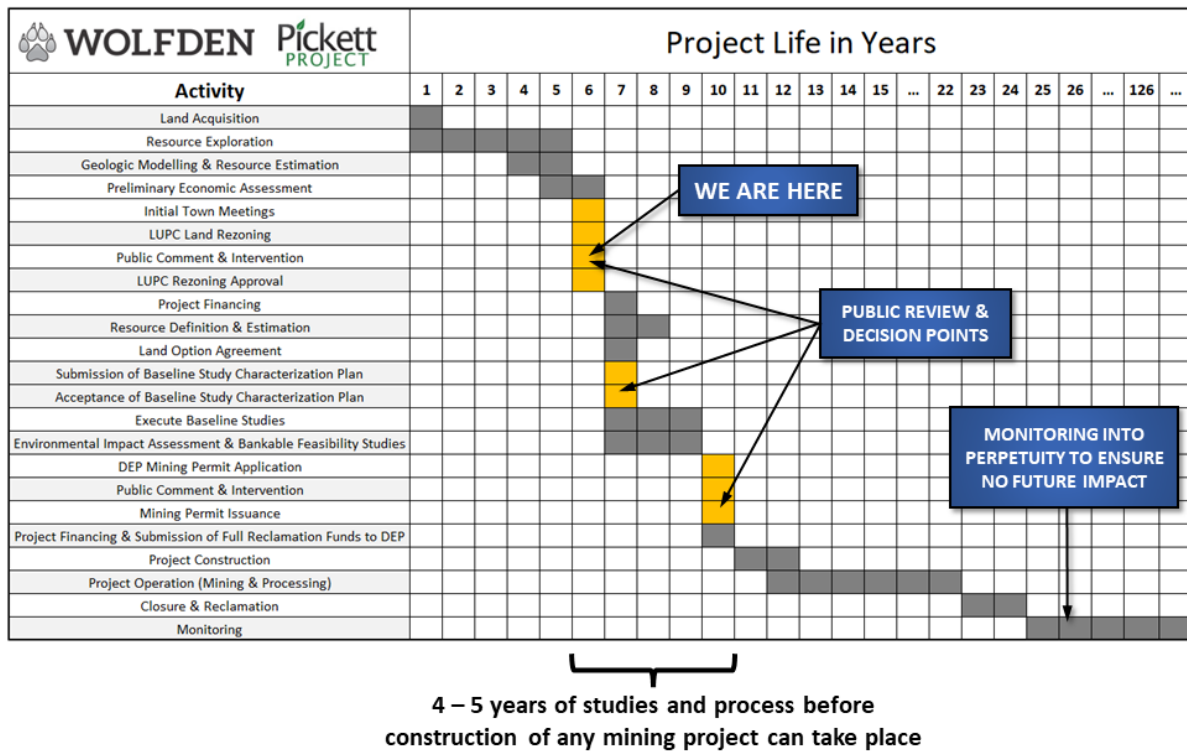

One of the goals of the Comprehensive Land Use Plan (CLUP) is to allow environmentally responsible exploration and mining of metallic and non-metallic resources where there are not overriding, conflicting public values which require protection.<sup>17</sup> The CLUP spells out the regulatory approach for permitting metallic mineral mining operations. First, the

<sup>16</sup> 06-096 C.M.R. ch.200, § 10(F)-(H).

<sup>17</sup> CLUP § 1.2(II)(G) (p.15).

area must be rezoned. If the Commission determines the area is appropriate for this type of use, “then the site review process follows, focusing on design, engineering and environmental protection.”<sup>18</sup> The rezoning phase focuses on the socio-economic and environmental effects; the site review process is designed to ensure a high-quality operation that is protective of existing uses and natural resources, and establishes specific data gathering requirements and standards regarding facility design, operation and closure.<sup>19</sup>

The comments from Maine Geological Survey (MGS) acknowledge the significance of the Pickett Mountain deposit and the two-step approach to permitting mining operations located in the unorganized jurisdiction. MGS has stated that:

there are currently very few mineral deposits in Maine known to be of significant size and grade. Of those few, the Pickett Mountain polymetallic deposit stands out as the most compatible with the objectives of the Maine Metallic Minerals Mining Act (MMMMMA) which favors small, high-grade deposits that can be mined underground, having less potential environmental impact than large, low-grade, surface mines. **Therefore, in our view, it would be more appropriate management of the deposit to allow it to proceed to the permitting phase as envisioned by the CLUP and regulated by the MMMMA, than to have it remain in the M-GM (sic) zone.**<sup>20</sup>

In closing, the statement of the MGS above, is consistent with what we have heard from the majority of people in the region. For that reason, we respectfully request that the Commission approve the rezoning and allow us to proceed to the second step in the process, which requires the collection of substantial additional information and development of more detailed engineering designs to demonstrate that the Project will comply with Maine’s stringent mining requirements.

---

<sup>18</sup> CLUP § 5.7.C (p. 219).

<sup>19</sup> CLUP § 5.7.C (p. 219).

<sup>20</sup> MGS’s comments are attached as Exhibit L (emphasis added).

On behalf of the entire Wolfden team I want to express our appreciation for the work and the time spent by the Commissioners and staff in considering this proposal. We look forward to providing further information during the public hearing and responding to all questions the Commissioners, staff, intervenors and the public may have.

Dated: Sept 20/23

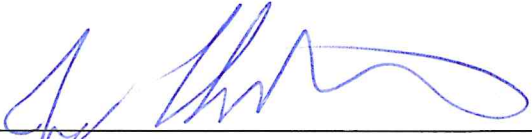
  
\_\_\_\_\_  
Jeremy Ouellette

Province of Nova Scotia  
~~STATE OF MAINE~~  
County of \_\_\_\_\_  
S.O  
Sep 20/23

Date: Sept 20, 2023

Personally appeared before me the above named Jeremy Ouellette, who, being duly sworn, did testify that the foregoing testimony was true and correct to the best of his knowledge and belief.

Before me,

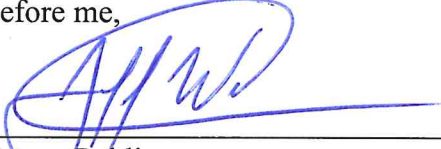
  
\_\_\_\_\_  
Notary Public  
My commission expires: N/A

**JEFFREY D. WAUGH**  
A Notary Public in and for the  
Province of Nova Scotia



# **EXHIBIT A**

**Maine DEP, Chapter 200 | Supplemental Reports and Studies Required to be Submitted as Part of Mining Application**

	<b>Application Supplement</b>	<b>Description</b>	<b>Citation</b>
1	Baseline Site Characterization Report	<ul style="list-style-type: none"> <li>• Defines existing conditions in proposed mining areas.</li> <li>• Provides sufficient data to perform qualitative and quantitative analyses required by DEP baseline workplan.</li> <li>• Performed by qualified professionals.</li> <li>• Provides basis for evaluating a statistically significant change in baseline conditions during operation, reclamation, and closure.</li> <li>• <u>Topics addressed in baseline study:</u> <ol style="list-style-type: none"> <li>(1) Presence, distribution and abundance of aquatic and terrestrial flora and fauna.</li> <li>(2) Water balance:                             <ul style="list-style-type: none"> <li>▪ Precipitation, evapotranspiration, infiltration, runoff, groundwater flow, hydraulic gradients, velocity, flow paths, elevation, groundwater/surface water interactions.</li> </ul> </li> <li>(3) Ambient water quality including:                             <ul style="list-style-type: none"> <li>▪ Surface and groundwater monitoring for metallic elements that have EPA maximum contaminant levels, or other toxics identified under Clean Water Act.</li> <li>▪ Baseline water quality of streams, ponds, wetlands.</li> <li>▪ Groundwater flow modeling for baseline, operations, and post-closure conditions.</li> </ul> </li> <li>(4) Climatological and meteorological conditions.</li> <li>(5) Watersheds, groundwater basins, aquifers, wells, springs, seeps.</li> <li>(6) Soils and other surficial deposits.</li> </ol> </li> </ul>	06-096 C.M.R. Ch. 200 § 9(C)(1)-(7)
2	Mining Operation Plan	<ul style="list-style-type: none"> <li>• Provides a detailed metallic mineral feasibility study that includes designs, plans, specifications, analyses, and schedules. All elements must be supported by data and information.</li> <li>• <u>Topics addressed in Mining Operation Plan:</u> <ol style="list-style-type: none"> <li>(1) Type and method of metallic mineral mining proposed.</li> <li>(2) Area, type, volume, and mineralogy of ore to be excavated.</li> <li>(3) Area, volume, characteristic of topsoil, overburden, lean ore, ore, waste rock to be excavated.                             <ul style="list-style-type: none"> <li>▪ Plans and schedules for excavation, segregation, processing, storing, and stabilizing.</li> <li>▪ Waste must be characterized according to acid rock drainage potential.</li> </ul> </li> <li>(4) Location, designs, and schedule for development.</li> <li>(5) Location, depth, dimensions of excavations, shafts, portals, and other openings.</li> <li>(6) Locations, dimensions and use of buildings and structures, including for storage and transfer of chemicals and explosives.</li> <li>(7) Transportation plan.</li> <li>(8) Infrastructure plan for electricity, water, wastewater, transportation of equipment, materials, and labor.</li> <li>(9) Beneficiation plan including type, method, materials, reagents, wastes, product, and equipment.</li> <li>(10) Tailings management plan.</li> <li>(11) Water management plan for storm water, surface water, groundwater, potable water, process water.                             <ul style="list-style-type: none"> <li>▪ Expected hydrological impacts.</li> <li>▪ Purpose, location, size, design, capacity of water impoundments, control structures and treatment facility.</li> </ul> </li> </ol> </li> </ul>	06-096 C.M.R. Ch. 200 § 9(D)(1)-(13)

		<ul style="list-style-type: none"> <li>▪ Location and estimated volume, rate, duration, and quality of expected discharges.</li> <li>▪ Wastewater treatment methods, design, and procedures.</li> </ul> <p>(12) Waste management plan. (13) Dust management plan.</p>	
3	Engineering Report	<ul style="list-style-type: none"> <li>• Presents the basis for engineering designs and proposed construction.</li> <li>• Identifies site-specific factors to be addressed during design phase.</li> <li>• Includes narrative of modes and significance of potential failures in engineering systems.</li> </ul>	06-096 C.M.R. Ch. 200 § 9(E)
4	Quality Assurance Plan (QAP)	<ul style="list-style-type: none"> <li>• Assures design specifications and performance will be met during construction, operation, reclamation, and closure</li> <li>• Topics addressed: <ul style="list-style-type: none"> <li>(1) Description of Construction Quality Assurance (CQA) measures.</li> <li>(2) Relationship between QAP, CQA, and bid documents.</li> <li>(3) Description of scope and authority of personnel involved in permitting, design, construction, operation, reclamation, and closure.</li> <li>(4) Qualifications of CQA personnel and testing laboratories.</li> <li>(5) Inspections and tests to be performed during mining operations to ensure compliance.</li> <li>(6) Sampling activities, methods, frequency, acceptance, and rejection criteria.</li> <li>(7) Record keeping and reporting requirements.</li> <li>(8) List of items requiring CQA and identify responsible engineers.</li> <li>(9) Process for evaluating CQA and inspector performance.</li> </ul> </li> </ul>	06-096 C.M.R. Ch. 200 § 9(F)(1)-(9)
5	Environmental Impact Assessment	<ul style="list-style-type: none"> <li>• Assessment identifying environmental issues relevant to the proposed project.</li> <li>• Requirements: <ul style="list-style-type: none"> <li>(1) Project description.</li> <li>(2) Resource and setting with description of areas affected, and natural and artificial features including: topography; land use; climate; visual resources; geology; water resources; hydrological features; towns, villages and counties; recreational, historic, cultural, archaeological, scientific, natural areas; public rights of way; biological resources, including endangered or threatened special; manmade structures.</li> <li>(3) Impact analysis to identify potential impacts.</li> <li>(4) Impact assessment results, analyses, findings.</li> </ul> </li> <li>• Must be performed in accordance with Federal permitting requirements.</li> </ul>	06-096 C.M.R. Ch. 200 §§ 9(G)(1)-(5); 10(C)(1)
6	Alternatives Analysis	<ul style="list-style-type: none"> <li>• Included as part of DEP assessment as to whether the project would unreasonably adversely affect existing uses, scenic character, air quality, water quality, or other natural resources.</li> <li>• Analysis considers the following: <ul style="list-style-type: none"> <li>(1) Siting alternatives.</li> <li>(2) Alternative technologies.</li> <li>(3) Modified scale or magnitude.</li> <li>(4) Alternative site selection for storage piles, water reservoirs, processing plants, storage, and handling areas.</li> <li>(5) Alternatives that were considered and eliminated through environmental impact assessment.</li> </ul> </li> <li>• Identifies adverse or beneficial environmental effects for each alternative identified.</li> <li>• Identifies measures that could reasonably eliminate or minimize any adverse environmental effect.</li> </ul>	06-096 C.M.R. Ch. 200 § 9(H)(1)-(6)
7	Mine Plan	<ul style="list-style-type: none"> <li>• Plan describing mine operations.</li> <li>• Includes the following:</li> </ul>	06-096 C.M.R. Ch. 200 § 9(I)(1)-(5)

		<ul style="list-style-type: none"> <li>(1) Mine siting, design, development, operation, reclamation, closure, post closure and corrective actions, including potential adverse impacts.</li> <li>(2) Detailed design, plan, specifications, techniques, methods, materials.</li> <li>(3) Basis for contention that there will be no adverse impact.</li> <li>(4) Description of reclamation plan, and closure and post-closure maintenance.</li> <li>(5) Detailed written cost estimate and cost rational for each category of the mine plan. Includes cost of investigating potential releases of contaminants, and costs for responding to worst-case catastrophic mine event/failure.</li> </ul>	
<b>8</b>	Monitoring Plan	<ul style="list-style-type: none"> <li>• Identifies sampling frequencies, procedures, techniques, data sheets, analytical procedures, data validation, reporting methods, analytical quality assurance, and control procedures for monitoring mine operations and the environment.</li> <li>• Methods must be submitted and approved by DEP.</li> <li>• Monitoring plan must include monitoring of the following: <ul style="list-style-type: none"> <li>(1) Groundwater</li> <li>(2) Surface water and sediments</li> <li>(3) Hydrology</li> <li>(4) Biological resources</li> <li>(5) Mining operations, including lagoon undertrains, leachate collection systems, impoundment drains</li> </ul> </li> <li>• Includes monitoring of reference location outside of mining area as point of comparison.</li> <li>• Includes proposed levels indicating statistically significant change from baseline for each parameter.</li> </ul>	06-096 C.M.R. Ch. 200 §§ 9(J), 22(A)-(b)
<b>9</b>	Contingency Plan	<ul style="list-style-type: none"> <li>• Assessment of risk to public health and safety associated with accident or failures.</li> <li>• Description of detection or warning systems.</li> <li>• Spill prevention and control countermeasures plan.</li> <li>• Response measures to be following if a potential accident or failure occurs.</li> <li>• Procedures for notifying the public, authorities, or safety agencies.</li> <li>• Plan for testing contingency planning to ensure effectiveness.</li> </ul>	06-096 C.M.R. Ch. 200 § 9(K)(1)-(8)
<b>10</b>	Financial Assurance	<ul style="list-style-type: none"> <li>• Required supplemental funds must be posted and fully funded prior to issuance of DEP permit.</li> <li>• Includes evidence of ability to cover the cost of DEP hiring 3d party to implement necessary investigation, monitoring, closure, post-closure, treatment, remediation, corrective action, reclamation, operation and maintenance.</li> <li>• Financial assurance amounts are based on qualified 3d party reviewer approved by DEP.</li> <li>• Financial assurance must include the highest cost option for all estimates and a minimum 20% contingency.</li> <li>• Financial assurance includes: <ul style="list-style-type: none"> <li>(1) Cash account in one more federal insured accounts.</li> <li>(2) Negotiable bonds issued by United States, state, or municipality meeting certain rating requirements.</li> <li>(3) Negotiable certificates of deposit in one or more federal insured depositories.</li> </ul> </li> </ul>	38 M.R.S. § 490-RR; 06-096 C.M.R. Ch. 200 §§ 9(L), 17



## **EXHIBIT B**



For a thriving New England

CLF Maine 53 Exchange Street, Suite 200  
Portland, ME 04101  
P: 207.210.6439  
F: 207.221.1240  
www.clf.org

April 13, 2023

Joint Standing Committee on Environment and Natural Resources  
Maine State Legislature  
100 State House Station  
Augusta, ME 4333

**RE: Testimony in Support of LD 1363, An Act to Support Extraction of Common Minerals by Amending the Maine Metallic Mineral Mining Act**

Senator Brenner, Representative Gramlich, and members of the Joint Committee on Environment and Natural Resources,

Thank you for the opportunity to provide testimony in support of LD 1363, An Act to Support Extraction of Common Minerals by Amending the Maine Metallic Mineral Mining Act. Conservation Law Foundation (“CLF”) is a member-supported nonprofit advocacy organization working to conserve natural resources, protect public health, and build healthy communities in Maine and throughout New England. I have been CLF’s Vice-President for Maine since 2007. We have been intimately involved in past efforts to amend Maine’s law and regulations governing mining in Maine, most recently in 2017, and appreciate the work of both prior ENR committees and the Department of Environmental Protection that has resulted in one of the best mining laws in the country, ensuring that any mining is done subject to the highest standards to protect surrounding natural resources and that the burden to meet those standards rests with those doing the mining. One need only look to the substantial federal dollars that will be spent – now estimated by some to be up to \$45 million – to clean up the long defunct Callahan mine in the Blue Hill peninsula to realize how important that is.

Yesterday’s briefing of this Committee by Commissioner Loyzim and her staff was an excellent overview of the general issues associated with mining, particularly the risks of substantial harm in the form of acid rock drainage that is caused by minerals and waste rock that contain sulfides. The processing of minerals also presents significant risks, particularly those that require chemical treatment to both extract the metals of economic value from the rock and the need to store the resulting waste rock, tailings and process water.

The bill before you today addresses the newest wrinkle in mining in Maine. As you are well aware, today there is a high premium on certain materials necessary to make the transition

to a clean energy economy. One of those materials is lithium and in 2021 a potentially large lithium bearing deposit was identified at an existing gem quarry in Newry. The lithium found there is located in a mineral known as spodumene, a common rock-forming silicate mineral. Importantly, there is a general recognition that spodumene is not a mineral or waste rock that generates acid rock drainage. However, as noted in a letter to the owner of the quarry who was looking to extract the spodumene, the Department concluded that the Metallic Mineral Mining Act was unclear as to whether spodumene should be treated in the same way as metallic minerals under the Act or in the same way as minerals such as granite and limestone, which share many of the same characteristics as spodumene, are treated under our rules governing quarrying. LD 1363 provides the clarity to address how spodumene should be treated under the Act in a balanced way that CLF supports.

Specifically, LD 1363 will allow the extraction of common minerals like lithium using open pit mining that is otherwise prohibited under the Act as long as it is established that the mine waste will not generate acid rock drainage or otherwise cause a violation of any applicable water quality standards. All other aspects of the Act should remain applicable, most importantly the financial assurance provisions for closure and reclamation of the mining operations. LD 1363 also calls for the Department to adopt rules to establish the standards for that reclamation and we are confident that the Department, with input from stakeholders keen to ensure that the Act remains a model for governing responsible mining, will move quickly to do just that.

Much has been made of the risks associated with mining, and particularly mining of the materials critical to the clean energy transition, and the often disproportionate burden of those risks that environmental justice populations bear. With the enactment of LD 1363, Maine has an opportunity to provide a significant amount of one of those critical materials, lithium, and to do so in a safe and responsible manner that does not disproportionately burden environmental justice populations. We urge this Committee to support this effort and to vote Ought to Pass on LD 1363.

Very truly yours,

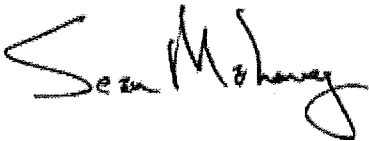
A handwritten signature in black ink that reads "Sean Mahoney". The signature is written in a cursive, slightly slanted style.

Sean Mahoney  
Senior Counsel and Vice President, CLF Maine

# Maine Enacts the Nation's Strictest Metal Mining Law

June 7, 2017

## Success Stories

Posted on June 7, 2017 by [NRCM](#)

Metal mining is one of the most dangerous industrial endeavors. Maine is a particularly risky place to mine because of the high levels of sulfides in metal deposits here and our rainy and snowy weather. Sulfides in metal deposits become sulfuric acid when exposed to air or water. Maine's wet springs and snowy winters would make control over acid-contaminated mining waste much more difficult than in dry climates.



**NRCM Staff Scientist Nick Bennett**

The Natural Resources Council of Maine (NRCM) fought for years against LePage Administration attempts to weaken our mining laws and rules. In 2012, Canadian mega-corporation JD Irving proposed to blast a huge open-pit metal mine on Bald Mountain in central Aroostook County. This site contains deposits with very high concentrations of both sulfur and arsenic, which could have exposed the surrounding area to severe damage from acid mine drainage and heavy metal pollution. A mine on Bald Mountain would have jeopardized the Fish River, endangering brook trout, landlocked salmon, and recreational fishing industries. JD Irving successfully lobbied the Maine Legislature to pass a law calling for weakened mining rules to allow a dangerous mine at Bald Mountain. In 2014 and again in 2015, Maine's Department of Environmental Protection (DEP) introduced new, weakened rules that would have allowed JD Irving to move forward with its project and could have opened up mining prospects in other places like Moosehead Lake, the Western Mountains, and Penobscot Bay. NRCM led a successful fight in the Legislature to defeat these weak rules two years running, but the battle was far from over.

In 2016, DEP proposed yet another set of weak mining rules. NRCM and Maine people fought back. Citizens turned out in droves to speak out against the disastrous scheme, with opponents outnumbering supporters 441 to 2. "Mainers were deeply concerned about the pollution and long-term financial costs that could have been left behind from metal mining in Maine," said NRCM



Staff Scientist Nick Bennett. “Mining pollution would have presented a serious threat to many of Maine’s traditional job-creating industries. The guiding, fishing, lobstering, and tourism industries all depend on Maine’s clean water.” Nevertheless, the LePage-appointed Board of Environmental Protection (BEP) unanimously approved the deregulations.

To resolve this issue once and for all, NRCM worked with the Legislature to draft a common-sense bill that contained the toughest protections against mining pollution in the United States, including:

- a ban on open-pit mining;
- a ban on mining in, on, or under public lands, lakes, outstanding rivers, coastal wetlands, and high-value freshwater wetlands;
- a ban on mines that would require treatment of toxic wastewater in perpetuity;
- a ban on tailings impoundments, the most dangerous parts of mines; and
- a requirement that mining companies pay enough money up-front to cover a worst-case mining disaster so Maine citizens don’t get stuck with cleanup costs for mining company messes.

The bill passed with overwhelming bipartisan majorities, even overriding a gubernatorial veto from then-Governor Paul LePage. “After five years of battles over mining, a strong bipartisan law will protect our clean water and taxpayers into the future. The law sets a new standard that could serve as a model for any state interested in protecting their citizens and environment from mining pollution,” said Bennett.

As a result of NRCM’s efforts, Maine’s mining law and rules are now the most protective in the country.

[Maine Enacts the Country's Strictest Metal Mining Law \(nrcm.org\)](http://nrcm.org)

# Maine Lawmakers Toughen Mining Rules, Overriding Governor's Veto

Maine Environmental News, Metal Mining Pollution, State House Watch, Waters

Posted on June 8, 2017 by [NRCM](#)

[Move likely to preserve state's long and informal moratorium on digging for metals](#)

By Jon Kamp

[Wall Street Journal news story](#)

Lawmakers in Maine have toughened the state's mining regulations, overriding a veto from Gov. Paul LePage to potentially lengthen the state's decadeslong, informal moratorium on digging for metals.

The new rules, sponsored by a Democratic state senator, require mining companies to set aside money for at least a century to cover cleanup after a mine shuts to limit future taxpayer liability. It also includes strict rules for handling waste and bans open-pit mining.

The restrictions passed with bipartisan support and won cheers from environmentalists who sought to protect the state's woodsy, sparsely populated northern wilderness. Nick Bennett, a staff scientist with the Natural Resources Council of Maine, called the new law a victory for the state, with strong protections "so that if mining companies come here, they do it right."

But the Republican governor said the restrictions would put the state at a competitive disadvantage. "This bill will deter any company from mining in Maine, and it will discourage exploration of our mineral deposits because this bill would make them undevelopable," Mr. LePage had said in his June 2 veto message.

Lawmakers overrode the mining veto Wednesday with a unanimous vote in the Republican-controlled Senate and a 122-21 vote in the Democratic-controlled House.

This is the latest clash between lawmakers and the governor, who has vetoed at least 460 bills since taking office in 2011, according to data from the nonpartisan Maine State Law and Legislative Reference Library. Nearly half of the vetoes have been overridden.

Maine lawmakers have been grappling for years over bills and rules that could determine whether any new mines are dug. Maine has deposits of metals like copper, zinc, gold and silver, but the state's last metallic-mineral mine closed in 1977.

In a press release, state Senate Democrats highlighted a former open-pit mine, which closed in 1972 and became a federal Superfund site with ongoing cleanup, as an example highlighting the need for tough restrictions.

Mining proponents have blamed regulations dating back to 1991 for hindering the industry. In 2012, the GOP-controlled legislature enacted changes with a law that directed state regulators to replace those rules. But the changes required even more legislative signoff, and lawmakers wound up rejecting the rules twice following changes in the legislature.

State records show closely held J.D. Irving Ltd., a conglomerate based in New Brunswick, Canada, that owns a huge swath of Maine land, lobbied for the 2012 law. As the debate ramped up again in 2015, a company spokeswoman said the company believed responsible mining can provide vital job creation in northern Maine, an isolated region hurt by paper mill closures. The debate at the time centered around Bald Mountain in Maine's northernmost county, where metal deposits were first found 40 years ago.

J.D. Irving didn't immediately respond to a request for comment on the new law.

[Maine Lawmakers Toughen Mining Rules, Overriding Governor's Veto \(nrcm.org\)](http://nrcm.org)

# **EXHIBIT C**



Map ID	Facility Name
1	SOLAR FACILITY (APPROX.)
2	LOW GRADE ORE STORAGE PAD
3	SNOW STORAGE
4	PRE-TREATMENT WATER STORAGE POND
5	WATER TREATMENT FACILITY
6	ELECTRICAL SUBSTATION
7	BACK-UP POWER GENERATION (DIESEL OR PROPANE)
8	POST-TREATMENT WATER STORAGE POND
9	WATER RECHARGE AREA #1
10	FIRE WATER PUMPHOUSE
11	SANITARY SUBSURFACE DISPOSAL SYSTEM
12	PARKING FACILITY
13	WAREHOUSE
14	OFFICES AND MINE RESCUE FACILITY
15	CORE SHACK AND STORAGE
16	LAYDOWN (EQUIPMENT/SUPPLIES STORAGE)
17	MAINTENANCE SHOP
18	EQUIPMENT FUELING STATION
19	WATER RECHARGE AREA #2
20	WASTE ROCK STORAGE PAD #1
21	BACKFILL PLANT
22	ORE (MILL FEED) STORAGE PAD #1
23	BLAST SHACK
24	MINE ACCESS (PORTAL)
25	EAST VENTILATION RAISE
26	ORGANICS STORAGE
27	WATER RECHARGE AREA #3
28	HEADFRAME AND HOIST
29	ORE (MILL FEED) STORAGE PAD #2
30	WASTE ROCK STORAGE PAD #2
31	TEMPORARY EXPLOSIVES STORAGE
32	WEST VENTILATION RAISE
33	WATER RECHARGE AREA #4
34	EXISTING SITE ROAD
35	PROPOSED SITE ROAD
36	SECURITY GUARD HOUSE/GATE
37	SECURITY FENCING
38	WATER RECHARGE AREA #5
39	WATER RECHARGE AREA #6

**LEGEND:**

---1125---	MAJOR CONTOURS
---1124---	MINOR CONTOURS
---	STREAM
---	EXISTING SITE ROAD
---	VERNAL POOLS
---	ASA - ARCHEOLOGICAL SENSITIVE AREAS
---	400-FOOT REZONING SETBACK BUFFER
---	PROPOSED REZONING
---	OLD REZONING
---	WETLAND
---	FACILITIES DESIGN
---	WATER COLLECTION AREA
---	WATER RECHARGE AREA
---	PHASE II (POST YEAR)
---	PROPOSED SITE ROAD
---	DRAINAGE DIVIDE
---	SECURITY FENCE
---	SECURITY GATE
---	CLEARING LIMIT

- NOTES:**
1. CONTOUR INTERVAL = 5 FT.
  2. TOPO CONTOURS ARE FROM LIDAR DATA (NOAA.GOV), MARCH 2021.
  3. INITIAL WETLAND, VERNAL POOL AND STREAM DATA WERE COLLECTED BY WOOD AND OTHERS IN MAY-JUNE OF 2020. ADDITIONAL WETLAND, VERNAL POOL, AND STREAM DATA WERE COLLECTED BY STANTEC-JUNE OF 2022. WETLANDS WERE DELINEATED IN ACCORDANCE WITH THE US ARMY CORPS OF ENGINEERS WETLAND DELINEATION MANUAL WETLANDS TECHNICAL REPORT (Y-87-1) AND THE NORTH CENTRAL AND THE NORTHEAST REGIONAL SUPPLEMENT (ERC/DCEL TR-12-1).
  4. WETLAND BOUNDARIES WERE DELINEATED WITHIN THE REZONE BOUNDARY AND MAY CONTINUE BEYOND THE SHADING SHOWN.
  5. THE STREAMS ON SITE WERE DELINEATED FOLLOWING THE NATURAL RESOURCE PROTECTION ACT (NRPA) IDENTIFICATION GUIDE FOR RIVERS, STREAMS, AND BROOKS (DANIELSON, 2018).
  6. VERNAL POOLS (VPS) WERE IDENTIFIED ON MAY 17, MAY 18, AND MAY 28, 2020, BASED ON PHYSICAL CHARACTERISTICS OF THE FEATURES INCLUDING ISOLATED WATER BODIES, WATER STAINED LEAVES, WATER LINES, SPHAGNUM MOSS AND THE PRESENCE OF HYDROPHYTIC VEGETATION AS WELL AS EGG MASS COUNTS OF SPOTTED SALAMANDERS AND WOOD FROGS WERE COLLECTED.
  7. WATER COLLECTION AREAS INCLUDE AREAS WHERE STORMWATER RUNOFF IS COLLECTED BY BERMS, SWALES, OR OTHER CONVEYANCE METHODS AND TREATED AT THE WATER TREATMENT FACILITY DUE TO POTENTIAL IMPACT FROM MINE OPERATIONS.

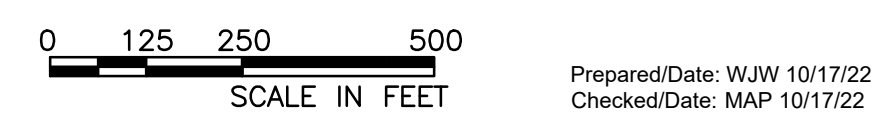

 Wolfden Mt Chase, LLC Rezoning Petition Location: T6 R6, Maine	 USA Earth & Environmental 511 Congress Street, Suite 200, Portland, ME 04112 (207) 775-5401	CONCEPTUAL SITE PLAN Project 3617-22-7547 Figure 2-1
--	--	---

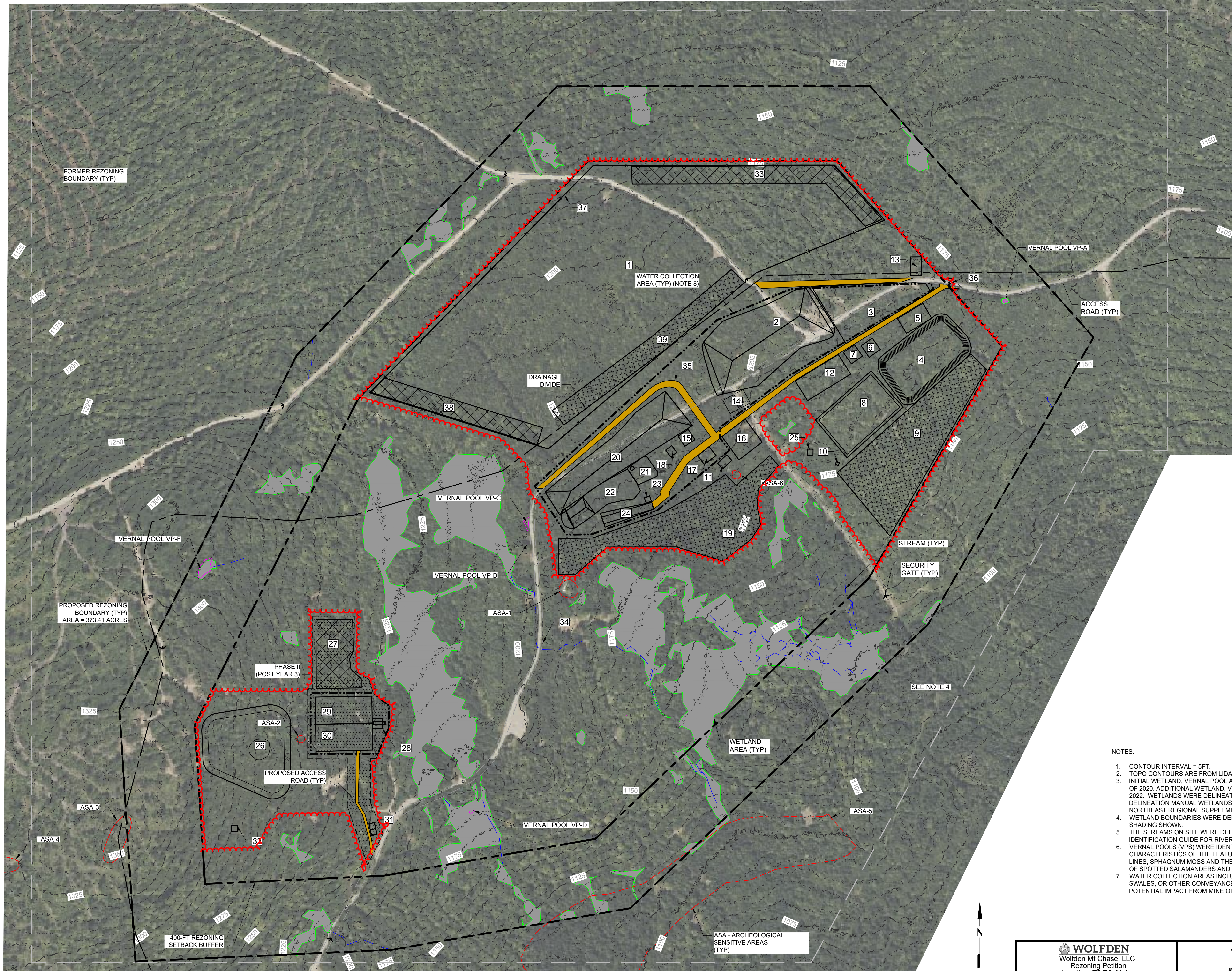

C:\Users\williamh\OneDrive - Wood - F:\Projects\Wolfden - 2022\Sheets\Design - 2022\Sheets\Figure 2 - Conceptual Site Plan.dwg Mon, 17 Oct 2022 11:17:07 AM  
 Resources: B:\D\Projects\Wolfden - 2022\Sheets\Design - 2022\Sheets\Figure 2 - Conceptual Site Plan.dwg Mon, 17 Oct 2022 11:17:07 AM  
 William Whitten



## **EXHIBIT D**

## **Guidance for Interpreting the 2010 Comprehensive Land Use Plan**

**Approved October 5, 2012**

### **I. Background**

The Maine Land Use Planning Commission (the LUPC or Commission) serves as the planning and zoning authority for the unorganized and deorganized areas of the State, including townships and plantations. These areas either have no local government or have chosen not to administer land use controls at the local level. Prior to the creation of the LUPC in 2012, the Land Use Regulation Commission (LURC) had regulatory authority within the unorganized and deorganized areas of the State.

The Commission is required by statute to adopt a Comprehensive Land Use Plan (the CLUP) and to “use that plan as a guide in developing specific land use standards and delineating district boundaries and guiding development and generally fulfilling the purposes of this chapter.” 12 M.R.S. § 685-C(1). The CLUP was last revised in 2010.

In 2012, the Maine Legislature made a number of changes to the statute that applies to the Commission’s activity (the 2012 Legislation). P.L. 2011, ch. 682 (enacting LD 1798). These changes included revisions to the description of the Commission’s purpose and scope and elimination of the Demonstrated Need criterion of the rezoning standard, among other changes. (Title 12, section 681, the statutory section containing the purpose and scope, as revised by the 2012 Legislation, is included as Attachment A.) The 2012 Legislation did not mandate revision of the CLUP.

The CLUP, itself, is not the equivalent of a regulatory standard and is not applied in the same manner as land use standards set forth in statute or rule. The CLUP, however, is an important guidance document that the Commission is required by statute to consider, and determine consistency with, when carrying out core planning and zoning functions and developing land use standards. The CLUP contains a vision for the unorganized and deorganized areas of the State and identifies goals and policies intended to help achieve this vision.

The CLUP states:

The Commission recognizes that goals or policies may at times conflict with one another and will, in such cases, balance the various policies so as to best achieve its vision for the jurisdiction.

(CLUP at 5.) Consistent with this recognition, when determining consistency with the CLUP or otherwise interpreting the CLUP, the Commission often must engage in a

balancing and, in so doing, assign the appropriate weight to be given to competing goals or policies. While the Commission has some discretion when interpreting the CLUP, this discretion is bound by statute. The Commission may not elect to interpret the CLUP in a manner inconsistent with State law. In light of the significant changes to the statutory provisions governing the Commission and its role, the Commission determined that it would be helpful to provide guidance to the Commission staff and the public as to how the changes contained in the 2012 Legislation affect interpretation of the CLUP.

This document is intended solely for guidance to Commission staff and the public when interpreting the Comprehensive Land Use Plan. The document may not be relied upon to create rights, substantive or procedural. The Commission reserves the right to act in accordance with its statute and regulations, including in a manner that may vary from this document. Nothing in this document shall be construed to supersede or replace the statute or rules administered by the Commission. In order to clarify the effects of recent statutory changes, the Commission states and adopts the following:

## **II. Role of the Comprehensive Land Use Plan**

As set forth in statute, the Commission uses the CLUP in carrying out its planning and zoning responsibilities and in development of land use standards:

- For the Commission to adopt or amend a land use district boundary the proposed district must be consistent with the CLUP, 12 M.R.S. § 685-A(8-A)(A); *see also id.* § 685-C(1);
- For the Commission to add a place to the State's expedited permitting area for wind energy development the proposed addition must not compromise the principal values and the goals identified in the CLUP, 35-A M.R.S. § 3453(3); and
- For the Commission to adopt or amend land use standards the proposed standards must be consistent with the CLUP, 12 M.R.S. § 685-A(8-B); *see also id.* § 685-C(1).

In addition, in the course of reviewing a permit application or Department of Environmental Protection (DEP) request for certification, to help resolve uncertainty about how to interpret or apply an applicable standard, specifically including those contained within Chapter 10 (Land Use Districts and Standards) of its rules, the Commission uses the CLUP as guidance to help inform its decision-making. The Commission's determination of conformance with the CLUP in the permitting and certification context does not call for findings of conformance with each of the CLUP's numerous and often competing goals and policies, but instead for conformance with the CLUP as more particularly expressed through specific land use standards articulated in statute and rule. 12 M.R.S. § 685-B(4)(E).



### **III. Statutory Changes Affecting the Commission**

The changes to the statutory sections governing the activities of the Commission contained in the 2012 Legislation range from broad policy statement revisions to highly technical changes. How the Commission interprets the CLUP in recognition of these changes is discussed below. This discussion is intended to serve as guidance to Commission staff and the public.

#### **A. An Increased Focus on Planning and Zoning**

The 2012 Legislation shifts permitting of development that triggers review under the Site Location of Development Law to the DEP. The Commission must certify that these projects permitted by the DEP (a) are an allowed use within the subdistrict or subdistricts in which they will be located and (b) meet any land use standards established by the Commission and applicable to the project that are not considered by the DEP in its review. P.L. 2011, ch. 682, § 15 (enacting 12 M.R.S. § 685-B(1-A)) and § 33 (enacting 38 M.R.S. § 489-A-1). Along with this shift in regulatory authority, the 2012 Legislation establishes that the former Land Use Regulation Commission is now the Land Use Planning Commission, *id.* §§ 6-7 (repealing 12 M.R.S. § 683 and enacting § 683-A), and directs the new Commission to initiate prospective zoning in coordination with local planning organizations and regional planning and development districts, *id.* § 34. Together, these changes reflect the intent that the Commission operate less as a reactive regulatory agency focused on protection of the jurisdiction through project-specific permitting and rezoning, and serve more as a forward-looking planning agency focused on helping residents, landowners, and people of the State to ensure a vibrant and sustainable future for the unorganized and deorganized areas of Maine.

The CLUP is a visionary guidance document and, in this respect, is consistent with the refocusing of a core part of the Commission's responsibilities on forward-looking planning and zoning. As part of its planning and zoning responsibilities, the Commission is tasked with balancing potentially competing interests and objectives. The need for this balancing is exemplified in the revised purpose and scope section of the statute governing the Commission. *Id.* § 3 (amending 12 M.R.S. § 681). In conducting the balancing that is necessarily part of its planning and zoning responsibilities, the Commission interprets the CLUP in a manner consistent with the Commission's revised purpose and scope, which, as discussed below, places increased emphasis on:

- Serving the regions in which the unorganized and deorganized areas are located,
- Honoring the rights and participation of residents and property owners, and
- Encouraging and facilitating regional economic viability.

**B. The Significance of Unorganized and Deorganized Areas to the Regions in Which They are Located and the Importance of Recognizing the Rights and Interests of Residents and Property Owners**

The 2012 Legislation alters the composition of the Commission, increasing membership to nine and establishing that, after completion of a transition period, eight members of the Commission will be nominated and appointed by each of the eight respective counties with the most acreage in the unorganized and deorganized areas; one member will be nominated and appointed by the Governor. *Id.* § 7 (enacting 12 M.R.S. § 683-A). Additionally, the 2012 Legislation allows for delegation of permitting authority to individual counties, *id.* § 16 (enacting 12 M.R.S. § 685-B(1-C)), and for a county or a group of counties to request that the Commission develop and implement a regional comprehensive land use plan and associated zoning for all the unorganized and deorganized areas within the requesting county or counties, *id.* § 22 (enacting 12 M.R.S. § 685-C(1-A)). Also, as noted above, the 2012 Legislation directs the Commission to engage in prospective zoning in cooperation with local and regional planning groups. *Id.* § 34. These changes reflect a desire to ensure that the Commission is responsive to local needs and interests, and attune to regional differences that may exist among different areas within the unorganized and deorganized portions of Maine. The Commission is respectful of this legislative intent when interpreting the CLUP.

The 2012 Legislation amends the statutory purpose and scope, adding language that directs the Commission “to honor the rights and participation of residents and property owners in the unorganized and deorganized areas.” *Id.* § 3 (amending 12 M.R.S. § 681). In light of this new language, the Commission pays particular attention to the rights of residents and property owners when interpreting the CLUP and, for example, places new emphasis on those provisions that (a) reference working cooperatively with land owners and residents and (b) encourage exploration of voluntary and incentive-based measures as an alternative to zoning restrictions and new regulation.

While the Commission interprets the CLUP with an increased emphasis on resident and landowner rights and participation and on acknowledgement of the local and regional significance of the unorganized and deorganized areas, the Commission continues, also as directed by the revised purpose and scope, to recognize the unique value of the lands and water in these areas to the State as a whole. *See id.*

**C. The Importance of Sound Planning and Zoning in Encouraging Appropriate Development and in Encouraging and Facilitating Regional Economic Viability**

The 2012 Legislation establishes that among the Commission’s purposes is to encourage appropriate economic development. This is reflected in the prospective zoning directive, as well as in multiple changes to the Commission’s purpose and scope. In addition to extending principles of sound planning and zoning to the unorganized and deorganized areas, the Legislature now has stated it is important to extend principles of sound

“development” to these areas, as well. *Id.* The 2012 Legislation also establishes that the Commission should no longer just “provide” for appropriate residential, recreational, commercial, and industrial land uses, but should now “encourage” these appropriate land uses. *Id.*

In recognition of these changes, the Commission views its role as not just regulating development and allowing this activity when regulatory standards are met, but also as using its planning and zoning authority to actively encourage appropriate economic development activity. The Commission interprets the CLUP in a manner consistent with this role. For example, the Commission places new emphasis on the provisions that reference a proactive approach (a) to identifying areas best suited for economic development activities, as well as (b) to siting appropriate residential, recreational, commercial, and industrial land uses, including through prospective zoning.

The 2012 Legislation places special emphasis on “Maine’s natural resource-based economy,” adding this phrase to the purpose and scope section in two places. *Id.* The statutory language makes clear that the Commission should work to “support and encourage” this sector of the economy and to “prevent” residential, recreational, commercial, and industrial uses detrimental to this key economic sector. *Id.* In recognition of the new, express references to Maine’s natural resource-based economy, the Commission interprets existing CLUP provisions addressing this economic sector with an increased emphasis on supporting and encouraging the natural resource-based economy, including existing and emerging industries within this sector.

The 2012 Legislation also establishes that it is within the Commission’s purpose and scope “to encourage and facilitate regional economic vitality.” *Id.* This statement combines the recognition of both the importance of the unorganized and deorganized areas to the regions in which they are located and the ability of the Commission, through advancement of principles of sound planning, zoning, and development, to help create an environment where economic development activities are better positioned to succeed. In recognition of its responsibility to help encourage and facilitate regional economic vitality, when interpreting the CLUP and balancing the goals and policies in this guidance document the Commission gives more active consideration to the impacts of its interpretations on regional economies.

#### **D. The Importance of Sound Planning and Zoning in Encouraging a Sustainable Future for the Unorganized and Deorganized Areas**

As discussed above, the 2012 Legislation refocuses key components of the Commission’s mission. For example, the Commission now has an increased focus on serving the regions in which the unorganized and deorganized areas are located, honoring the rights and participation of residents and property owners, and encouraging and facilitating regional economic viability. While the Commission now places new emphasis on these responsibilities, the 2012 Legislation also reaffirms, through both the retention of previously existing purpose and scope language and the addition of new language, that

the Commission’s responsibility to support and encourage “strong environmental protection” continues. *Id.*

The 2012 Legislation provides new direction to the Commission about how to balance its multiple responsibilities in light of varying and sometimes competing interests. Sustainability is the goal. This is reflected in amendments that favor conservation over preservation and recognize that conservation and economic vitality are not mutually exclusive. For example, the 2012 Legislation states that one of the Commission’s purposes is to “conserve” ecological and natural values, where previously the Commission was to “protect” these values. *Id.* This revised purpose is listed along with the other purposes discussed above. The revised purpose and scope also contains the Legislature’s declaration that it is in the public interest “to encourage the well-planned and well-managed multiple use, including conservation, of land and resources and to encourage and facilitate regional economic viability.” *Id.*

The importance of sustainability is further evident in the focus on supporting and encouraging Maine’s natural resource-based economy. Supporting this economy depends on responsibly and sustainably managing the resources that form the basis of this economy. This also is reflected in the new, express reference to the importance of the “long-term health” of the unorganized and deorganized areas and of Maine natural resource-based economy. *Id.*

The CLUP is an extensive document that acknowledges and discusses the varied responsibilities of the Commission. While the 2012 Legislation does not create entirely new responsibilities for the Commission relative to the CLUP, what is significant about the legislation is that it directs the Commission to refocus some of its efforts as discussed above. Accordingly, the Commission interprets the CLUP in a manner that is respectful of the current law, as amended by the 2012 Legislation, when balancing the competing goals and policies in this guidance document.

#### **E. The Removal of the Demonstrated Need Criterion from the Zoning Standard**

Finally, the 2012 Legislation amends the criteria for adoption or amendment of land use district boundaries, *i.e.*, the rezoning standard, by eliminating the requirement that the proposed land use district satisfy a “demonstrated need” in the community or area. *Id.* § 13 (amending 12 M.R.S. § 685-A(8-A)). The Commission interprets the CLUP in a manner consistent with this statutory change and no longer giving weight to language related to the demonstrated need criterion.

#### **IV. Duration of Guidance**

The Commission will apply this Guidance for Interpreting the 2010 Comprehensive Land Use Plan until the earlier of (a) any future revision of the CLUP approved by the Legislature or adopted by the Commission following legislative inaction, or (b) a formal vote of the Commission to modify or repeal this guidance.



**Attachment A:**

**12 M.R.S. § 681**

**Section 681. Purpose and Scope**

The Legislature finds that it is desirable to extend principles of sound planning, zoning and development to the unorganized and deorganized townships of the State: To preserve public health, safety and general welfare; to support and encourage Maine's natural resource-based economy and strong environmental protections; to encourage appropriate residential, recreational, commercial and industrial land uses; to honor the rights and participation of residents and property owners in the unorganized and deorganized areas while recognizing the unique value of these lands and waters to the State; to prevent residential, recreational, commercial and industrial uses detrimental to the long-term health, use and value of these areas and to Maine's natural resource-based economy; to discourage the intermixing of incompatible industrial, commercial, residential and recreational activities; to prevent the development in these areas of substandard structures or structures located unduly proximate to waters or roads; to prevent the despoliation, pollution and detrimental uses of the water in these areas; and to conserve ecological and natural values.

The Legislature declares it to be in the public interest, for the public benefit, for the good order of the people of this State and for the benefit of the property owners and residents of the unorganized and deorganized townships of the State, to encourage the well-planned and well-managed multiple use, including conservation, of land and resources and to encourage and facilitate regional economic viability. The Legislature acknowledges the importance of these areas in the continued vitality of the State and to local economies. Finally, the Legislature desires to encourage the appropriate use of these lands by the residents of Maine and visitors in pursuit of outdoor recreation activities, including, but not limited to, hunting, fishing, boating, hiking and camping.

## **EXHIBIT E**

## Wolfden Community Engagement

<b>Type of Outreach</b>	<b>Description / Organizations</b>	<b>Meeting Dates</b>
Recreational Meetings	Kahahdin Valley Wheeler's ATV Club	April 23, 2021
	Patten ATV Club	June 6, 2021
	East Branch Sno Rovers ATV Club	December 6, 2021
	Bowlin Matagamon Shin Pond Snowmobile Club	January 15, 2023
	Northern Timber Cruisers Snowmobile/ATV/Ski Club	February 1, 2023
	Molunkus Snowmobile Club	February 4, 2023
	Rockabema Snow Rangers Snowmobile Club	February 11, 2023
Community Meetings	Houlton Rotary	October 14, 2021
	Fiddlers & Fiddlehead Festival	May 21, 2022
	Lumberman's Museum	May 21, 2021
	Patten Pioneer Days	August 1, 2022
	Bean Hole Bean Dinner (Lumberman's Museum)	August 12, 2022
	Houlton Rotary Club	May 5, 2023
	Fiddlers & Fiddlehead Festival	May 20, 2023
	Pioneer Days Bean Hole Bean Dinner	August 12, 2023
	Pioneer Days Chicken BBQ (Shin Pond Village)	August 12, 2023
Educational Meetings	University of Maine Presque Isle (geology of deposit)	May 30, 2019
	Northern Maine Community College (project hiring and training)	June 4, 2021
	University of Maine Presque Isle (educational programs)	February 1, 2023
	University of Maine Presque Isle (educational programs)	February 23, 2023
	Houlton Region 2 school	March 20, 2023
Economic and Youth Development Meetings	Eastern Maine Development Corporation	February 8, 2021
	Our Katahdin	May 19, 2021
	Presque Isle Kiwanis	May 25, 2021
	Aroostook County	June 8, 2021
	Maine Chamber of Commerce	October 19, 2021
	Dover-Foxcroft Kiwanis	October 19, 2021
	Upper Valley Economic Corporation	May 3, 2022
	Upper Valley Economic Corporation	December 19, 2022
Katahdin Regional Development Board	February 2, 2023	

	Presque Isle Job Fair	March 15, 2023
	Greater Houlton Chamber of Commerce	March 21, 2023
	Central Aroostook Chamber of Commerce	March 21, 2023
	Southern Aroostook Development Corporation	April 5, 2023
	Southern Aroostook Development Corporation	May 4, 2023
	Our Katahdin	July 19, 2023
Community Advisory Committee Meetings	Community Advisory Committee	March 29, 2023
	Community Advisory Committee	May 31, 2023
	Community Advisory Committee	August 23, 2023
Municipal Meetings	Medway Board of Selectmen (presentation and Q&A)	February 25, 2020
	Hersey Selectmen	June 1, 2022
	Sherman Selectmen	June 1, 2022
	Stacyville Special Town Meeting	July 20, 2022
	Patten Board of Selectmen	September 27, 2022
	Island Falls Selectboard	September 28, 2022
	Hersey Special Town Meeting	October 6, 2022
	Patten Board of Selectmen	November 1, 2022
	Moro Board of Selectmen/Residents	November 17, 2022
	Patten Board of Selectmen	November 29, 2022
	Mount Chase Board of Selectmen/Residents	December 8, 2022
	Moro Special Town Meeting	December 14, 2022
	Stacyville Board of Selectmen	December 18, 2022
	Mount Chase Board of Selectmen	January 4, 2023
	East Millinocket Board of Selectmen	January 10, 2023
	Sherman Board of Selectmen/Residents	January 12, 2023
	Patten Planning Board	January 19, 2023
	Hersey Board of Selectmen	January 23, 2023
	Mount Chase Board of Selectmen/Residents	January 30, 2023
	Crystal Board of Selectmen	February 9, 2023
	Sherman Annual Town Meeting	February 20, 2023
	Patten Board of Selectmen	February 21, 2023



	Sherman Board of Selectmen	February 21, 2023
	Island Falls/Crystal Residents	February 27, 2023
	Mount Chase Board of Selectmen	March 1, 2023
	Mount Chase Special Town Meeting	April 5, 2023
	Patten Special Town Meeting	April 13, 2023
	Mount Chase Special Town Meeting	May 23, 2023
	Millinocket Town Manager	July 19, 2023
Wolfden Hosted Events	Community BBQ	October 5, 2022
	Community Holiday Party	December 15, 2022
	Community Spring Party	April 11, 2023
	Pioneer Days Geology Event	August 8, 2023

## **EXHIBIT F**

# TOWN OF HERSEY, MAINE

## COMMERCIAL/INDUSTRIAL MINING ORDINANCE

Adopted on October 6, 2022

### *PREAMBLE*

The Town of Hersey currently does not have a Comprehensive Plan or town-wide zoning. As a result, all lawful uses of property are allowed in Town subject to the state-imposed mandatory Shoreland zoning regulations. Lawful uses include metallic mining activities.

The Town of Hersey is aware that potential metallic mineral deposits exist in and around the Pickett Mountain area, which is adjacent to the northwestern portion of Hersey. A reasonable prospect exists that a mining project may be pursued in the Pickett Mountain area, which could include portions of the project facilities being located in the Town of Hersey.

In the judgment of the Board of Selectmen, it is in the interests of the Town of Hersey to determine whether a mining project, or more specifically a portion of a mining project, would be acceptable in the Town of Hersey subject to State and Federal laws and regulations and local ordinance requirements set forth herein. Further, since mining projects have lengthy and costly resource assessment and application requirements (e.g., the mining rules administered by the Maine Department of Environmental Protection or MDEP), it is reasonable for potential mining project applicants to understand whether a project would be acceptable in the Town of Hersey subject to satisfying all regulatory requirements and standards.

In light of the above, in the summer of 2022 the Board of Selectmen conducted a public informational process on mining issues that resulted in the development of this Ordinance, including a public hearing held on September 22, 2022.

Fundamentally, the purpose of this Ordinance is to allow a mining project, or portion of a mining project, located in the Town of Hersey provided the project satisfies all regulatory requirements and standards. This includes Chapter 200 of the MDEP Rules, which were updated in 2017 to provide more comprehensive, stringent, and robust mining standards in the State of Maine, as well as this Ordinance.

Further, the purpose of this Ordinance is to have local processes and requirements specific to metallic mining activities that otherwise do not exist in the Town in order to help ensure the public health, welfare, and safety. This Ordinance, among other things, establishes a *maximum* setback distance for metallic mining activities from Route 11 thereby restricting such activities to that setback area, and a *minimum* setback distance for metallic mining activities from the property line of parcels including

residences to ensure such facilities are not in close proximity to homes. It also addresses other local considerations such as truck traffic.

Moreover, this Ordinance ensures the Town of Hersey realizes significant tangible benefits in the form of a community benefit agreement, which would not otherwise be a requirement absent this Ordinance.

\* \* \*

### **SECTION 1 – TITLE; EFFECTIVE DATE.**

This ordinance shall be known and may be cited as *The Town of Hersey Commercial/Industrial Mining Ordinance*, hereinafter the “Ordinance”.

The effective date of this Ordinance shall be the date of its adoption, October 6, 2022.

### **SECTION 2 – PURPOSE; AUTHORITY.**

The purpose of this Ordinance is to establish minimum local standards regarding certain mining activities in the Town of Hersey to protect the health, safety, and general welfare of the inhabitants of Hersey. It is adopted pursuant to the home rule authority of the Town of Hersey pursuant to the Maine Constitution and 30-A M.R.S. § 3001 et al.

This Ordinance shall be in addition, and not in lieu of or a substitute, to any other local, state, or federal requirements applicable to any mining activity governed by this Ordinance.

### **SECTION 3 – APPLICABILITY.**

This Ordinance shall apply to any mining activity in the Town of Hersey that requires issuance of a permit by the Maine Department of Environmental Protection (“MDEP”) under its regulations promulgated under Chapter 200 “Metallic Mineral Exploration, Advanced Exploration and Mining”. Such activities are hereinafter referred to as “Regulated Mining Activities”.

Without limiting the generality of the foregoing, “Regulated Mining Activities” shall include all construction and operational activities of and concerning facilities or processes necessary for the preparation, processing, treatment, or otherwise arranging, handling, storing, or transporting metallic minerals and/or associated waste storage, stockpiling, or reclamation activities associated with a mining project regulated by Chapter 200 of the MDEP Rules. This includes without limitation the construction and operation of any facility designed to process mined material for the purpose of separating or purifying metallic minerals and associated waste rock (tailings) storage (e.g., dry stack tailings management).



## **SECTION 4 – ADMINISTRATION.**

This Ordinance shall be administered by the Hersey Board of Selectmen, except as otherwise noted herein.

## **SECTION 5 – NOTICE OF BASELINE STUDIES/RESOURCE ASSESSMENT ACTIVITIES.**

A person/entity pursuing a Regulated Mining Activity (an "Applicant") shall submit a written Notice of Baseline Studies/Resource Assessment to the Hersey Board of Selectmen within 30 days of submitting a baseline work plan (as required by Chapter 200 of the MDEP Rules) to the MDEP.

The Notice of Baseline Studies/Resource Assessment shall include and be subject to the following:

1. Name of Project Owner. The Applicant shall submit ownership information of the person(s) or entity(ies) that are the project owners of the proposed activity.
2. Project Participant Information, Organizational Chart. The Applicant shall submit information identifying project participants (e.g., landowners, technical consultants, etc.) that will be participating in the baseline studies/resource assessment activities. This may take the form of an organizational chart or equivalent document. The Applicant shall provide any material changes to the Hersey Board of Selectmen as part of the periodic updates with the Board.
3. Description/Scope of Baseline Studies/Resource Assessment Activities. The Applicant shall submit a detailed statement describing the scope and nature of the baseline studies/resource assessment activities, which shall include a map identifying the area of interest and other relevant attributes (e.g., surrounding environs). The Applicant shall provide any material changes to the area of interest and baseline studies/resource assessment activities to the Hersey Board of Selectmen as part of the periodic updates with the Board.
4. Semi-Annual Report (e.g., every 6 months). The Applicant/Permittee shall provide, at a minimum, semi-annual written reports to the Hersey Board of Selectmen describing the status of the baseline studies/resource assessment activities in the Town of Hersey and proposed project as a whole, as well as meet with the Board of Selectmen, if requested to do so, on a semi-annual basis. The Applicant and Board of Selectmen shall discuss and determine a mutually agreeable schedule.
5. Compliance with Laws/Regulations. The Applicant shall comply with all applicable local, state, and federal laws and regulations applicable to the baseline studies/resource assessment activities.

## **SECTION 6 – TOWN PARTICIPATION IN MDEP CHAPTER 200 APPLICATION PROCESS; ADDITIONAL LOCAL MEETINGS ON MDEP APPLICATION.**

The MDEP Chapter 200 Rules include specific provisions regarding local participation by the Town including, for example, the ability of the Town to review and comment on the following:

1. Baseline Work Plan. An Applicant's proposed work plan to conduct baseline studies (the aforementioned "baseline work plan");
2. Draft Scoping Plan of Environmental Impact Statement. An Applicant's proposed draft scoping plan associated with an Environmental Impact Statement;
3. Mining Permit Application. An Applicant's application for a mining permit pursuant to Chapter 200 ("MDEP Mine Permit Application"), including participation in adjudicatory hearings and the ability to obtain assistance grants; and
4. Site Access. Access to the proposed project site for inspection and investigation.

In addition, and not as a duplication or as a substitute or in lieu of the above opportunities, an Applicant shall host and pay all costs associated with no fewer than two and, upon the request of the Board of Selectmen, up to four public meetings to discuss the MDEP Mine Permit Application and the potential impacts and benefits of the proposed project to the Town as more particularly described below (the "Supplemental Local Process"):

- The dates, location, and format for each of the meeting shall be agreed upon by the Board of Selectmen and the Applicant in advance of such meeting.
- The Applicant shall provide public notice of the meetings by (i) posting the details of the meeting in the Town office no less than seven days prior to the meeting, and (ii) mailing to all property owners in Hersey as determined from the most recent tax records if requested by the Board of Selectmen.
- Each meeting shall be dedicated to topic(s) identified in advance by the Board of Selectmen and must be identified in the public notice for the meeting.
- The Applicant must present information on the topic(s) identified by the Board of Selectmen for the meeting and identified in the public notice for the meeting and have subject matter experts present to answer questions on the topic(s) presented.
- The Board of Selectmen may take comment from the public.

The Board of Selectmen may opt to hold one or more public meetings required by this section jointly with municipal officials from adjacent municipalities that may have an interest in the MDEP Mine Permit Application.

If the Town wishes to retain outside experts to evaluate information presented in the MDEP Mine Permit Application or as part of the Applicant's presentations pursuant to this Section, then the Applicant shall reimburse the Town for the reasonable costs of retaining such experts in an aggregate amount not to exceed \$25,000, unless otherwise agreed upon in writing. The Town's use of outside experts pursuant to this section is in addition to but shall not be in duplication of the Town's use of outside experts and any Municipal Intervenor Grant provided to the Town in the MDEP Mine Permit Application process.

The Supplemental Local Process may include consideration of the submissions and standards for issuance of the construction/operations permit discussed below and must be completed prior to issuance of any construction/operations permit.

#### **SECTION 7 – CONSTRUCTION/OPERATIONS PERMIT REQUIRED.**

Prior to constructing and operating a Regulated Mining Activity, a construction/operations permit is required from the Hersey Board of Selectmen, including satisfaction of any pre-construction conditions.

#### **SECTION 8 – SUBMISSION REQUIREMENTS AND PERMIT STANDARDS FOR REGULATED MINING ACTIVITIES.**

A permit for a Regulated Mining Activity shall not be issued by the Hersey Board of Selectmen unless the following submissions and standards are met:

1. Name of Owner. The Applicant shall submit ownership information regarding (i) the property owner where the activity is proposed; and (ii) if different from the underlying property owner, the project owner.
2. Name of Operator; Organizational Chart. The Applicant shall submit operator information of the proposed activity. In addition, the Applicant shall submit an organizational chart or equivalent document identifying the project participants and describing their relationships.
3. MDEP Permits, Licenses, or Other Approvals. The Applicant must submit copies of all MDEP permits, licenses, or other MDEP approvals as evidence of satisfying all requirements and conditions of those laws and regulations (e.g., MDEP Chapter 200 Rules).

The Board may issue a construction/operations permit prior to submission of the MDEP permit if the construction/operations permit is specifically conditioned

upon submission of all approved MDEP permits, licenses, or other MDEP approvals.

4. Additional Submissions. The Applicant shall submit further information responsive to the Local Standards set forth below.
5. Local Standards.
  - a. *Maximum Distance from Route 11.* A Regulated Mining Activity (excluding utility lines and roads that may be associated with a Regulated Mining Activity) shall be located no further than 1.5 miles east and 1.5 miles west on either side of the portion of Route 11 wholly within the Town of Hersey.
  - b. *Minimum Setbacks from Residences.* A Regulated Mining Activity (excluding utility lines and roads that may be associated with a Regulated Mining Activity) shall be no closer than ¼ mile from the property boundary of a parcel containing an existing residence. For purposes of this provision, an existing residence is a building or structure maintained and used for year-round residential occupancy that includes permanent indoor sanitary facilities, and that is in existence and used as of the date that the Notice of Baseline Studies/Resource Assessment required in Section 5 above is filed with the Town. A residence does not include a seasonal camp.
  - c. *Truck Route Plan.* A preferred Truck Route Plan shall be submitted depicting truck routes. As a condition of approval, the final approved preferred Truck Route Plan shall be provided to all applicable contractors/operators (e.g., truckers), and must abide by any local or state road limitations (e.g., weight limits).
  - d. *Complaint Protocol.* The Applicant shall submit a Complaint Protocol for review that sets forth procedures and requirements to address complaints regarding the proposed Regulated Mining Activity.
  - e. *Tangible Benefits.* The Applicant shall submit a Tangible Benefit Plan, Statement, or Report demonstrating the Regulated Mining Activity will result in significant tangible benefits for the Town of Hersey. "Significant tangible benefits" include, without limitation, consideration of additional tax revenue, host community benefit agreements, employment opportunities, or other economic benefits realized or to be realized by the Town of Hersey.
  - f. *Sound/Noise.* A Regulated Mining Activity shall not cause excessive noise that could degrade the health and welfare of nearby neighbors and shall demonstrate compliance with the sound level limits contained in Section 10 of Chapter 375 of the MDEP Regulations (No Adverse Environmental



Effect Standards), which are hereby incorporated by reference and made standards of this Ordinance. A determination by the MDEP that these sound level limits are met shall constitute compliance with these sound/noise standards.

- g. *Dust; Fumes; Odors.* A Regulated Mining Activity shall not generate or otherwise cause unreasonable dust, fumes, or odor emissions beyond the property boundary where the Regulated Mining Activity is located.
- h. *Lighting.* A Regulated Mining Activity shall not cause excessive light pollution and shall utilize reasonable measures to avoid or minimize glare, light trespass, and "sky glow" to protect night sky and prevent any lighting nuisances on adjacent properties or public right-of-ways.

Lighting shall not produce strong, dazzling, flashing, or reflection of light beyond what is necessary for operations.

Unless necessary for safety or otherwise required by state or federal law, lighting shall be shielded and hooded and directed downward so as not to light up the night sky.

#### 6. Additional Conditions of Approval

- a. Reporting. As a condition of approval, the Applicant/Permittee shall provide an annual report within 120 days of the end of the calendar year, regarding the Regulated Mining Activity for the prior year period. The annual report shall summarize the activities of the permittee and include, without limitation, a description of environmental management and compliance items with all applicable approvals. Such reporting requirements shall also apply to any post-operations phase of the mining project (i.e., post-closure). Post-operations reporting requirement shall be co-extensive in time with the MDEP Chapter 200 reporting requirements.
- b. Compliance with Laws/Regulations. As a condition of approval, the Applicant/Permittee shall comply with all local, state, and federal laws and regulations applicable to the Regulated Mining Activity.

### **SECTION 9 – AUTHORIZATION TO CONSTRUCT AND OPERATE REGULATED MINING ACTIVITIES.**

Upon issuance of a Construction/Operations Permit to conduct Regulated Mining Activities, the permittee is authorized to construct and operate for as long as the Permittee obtains and maintains valid permits, licenses, and approvals under state and federal laws and regulations and complies with the provisions of this Ordinance.

## **SECTION 10 – ENFORCEMENT.**

In the event that the Complaint Protocol does not result in resolution of alleged violations, the Town may (i) refer the matter to the MDEP and request that the MDEP take appropriate enforcement of alleged violations of Chapter 200, or (ii) commence formal local enforcement of alleged violations of Local Standards.

The Hersey Code Enforcement Officer shall have the authority to enforce the provisions of this Ordinance and, if necessary, refer any unresolved asserted violations to the Hersey Board of Selectmen for further action.

Upon issuance of any Notice of Violation (“NOV”), the Code Enforcement Officer and Permittee shall meet to discuss the alleged violations and potential resolution. If the violation has not been resolved, then the Code Enforcement Officer shall issue a “Final NOV”, which shall be a final decision appealable to the Hersey Board of Selectmen.

In addition, when the above actions do not result in the correction or abatement of a violation, the Board of Selectmen may institute any and all actions and proceedings appropriate or necessary to enforce the provisions of this Ordinance in the name of the Town of Hersey including without limitation the provisions of 30-A M.R.S. § 4452.

## **SECTION 11 – APPEALS.**

Any final decision under this Ordinance concerning the issuance or non-issuance of a permit may be directly appealed to the Maine Superior Court in accordance with Rule 80B of the Maine Rules of Civil Procedure. To remove any doubt, any decision regarding a permit must be marked “Final Decision” and include the date of issuance.

Any final decision by the Code Enforcement Officer under this Ordinance concerning an enforcement decision or order may be appealed to the Hersey Board of Selectmen within 30 days of the date the final decision is issued. To remove any doubt, any decision regarding enforcement must be marked “Final Decision” and include the date of issuance.

The Board of Selectmen shall conduct a *de novo* standard of review of such appeals. Any final decision of the Board of Selectmen concerning an enforcement matter may be appealed to the Maine Superior Court in accordance with Rule 80B of the Maine Rules of Civil Procedure.

## **SECTION 12 – SEVERABILITY.**

The invalidity of any section or provision of this Ordinance shall not be held to invalidate any other section or provision of this Ordinance.

#####

**HERSEY BOARD OF SELECTMEN**  
**ORDINANCE CERTIFICATION PURSUANT TO 30-A M.R.S. § 3002**

The undersigned Hersey Board of Selectmen hereby certify this "Town of Hersey, Maine Commercial/Industrial Mining Ordinance", a copy of which has been provided to the Hersey Town Clerk to be kept as a public record with copies made available for distribution to voters and at the Special Town Meeting on October 6, 2022 at 7:00 PM at the Patten Public Works Garage, Katahdin Street, Patten, Maine.

Dated: **September 29, 2022.**

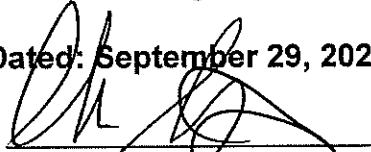

Chris Streinz  
Board of Selectmen

\_\_\_\_\_  
Ken Libby  
Board of Selectmen

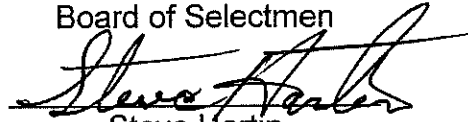

Steve Hartin  
Board of Selectmen

# Town of Hersey

21 Katahdin Street  
PO Box 236 Patten, Maine 04765 Phone (207)528-2215 Fax (207)528-2055

## SPECIAL TOWN MEETING MINUTES

Special Town Meeting Date : Thursday, October 6, 2022

Special Town Meeting Time : 7 :00 PM

Location : Patten Public Works Garage

21 Katahdin Street

Patten, Maine

Chris Streinz called the meeting to order at 7 :01 P.M.

Roll Call :

Selectmen : Chris Streinz, Ken Libby, Steve Hartin

Hersey Lawyer : Jonathan Pottle (Eaton Peabody)

Town Agent/Town Clerk : Billie Doody

### GREETING :

In the name of the State of Maine, you are hereby required to notify and warn the inhabitants of the Town of Hersey in said county and state, qualified by law to vote in town affairs, to meet at the Patten Public Works Garage on Katahdin Street in Patten Maine, on Thursday, the 6th day of October, 2022 A.D. at 7 :00 P.M., then and there to act upon the following articles :

#### **Article 1. To choose a Moderator to preside at said meeting.**

**Chris Streinz made a motion to nominate Ed MacArthur to preside as the Moderator. Ken Libby seconded the motion for Ed MacArthur to preside as the Moderator. No discussion. All in favor. Article carries.**

#### **Article 2. Shall an ordinance entitled « Town of Hersey Maine Commercial/Industrial Mining Ordinance » be enacted ?**

**Helene Crabtree motioned for the ordinance to be accepted as written and enacted. Frank Schramm seconded the motion to accept and enact the ordinance. Floor opened for discussion : no discussion. 11 voted in favor and 1 voted against. Article carries.**

Chris Streinz motioned to adjourn the meeting. Steve Hartin seconded the motion. All in favor. Meeting adjourned at 7 :16 pm.

Signatures :

Chris Streinz

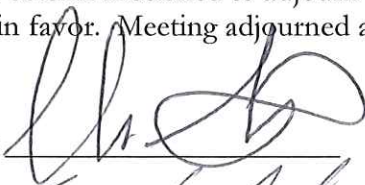

Steve Hartin

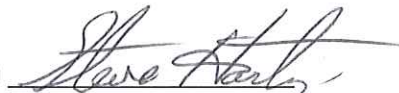

Ken Libby





# **EXHIBIT G**

# TOWN OF PATTEN

21 Katahdin Street | PO Box 260 | Patten, ME 04765

Phone (207) 528-2215 | Fax (207) 528-2055

[www.pattenmaine.org](http://www.pattenmaine.org)

---

## Special Town Meeting Minutes

Thursday, April 13<sup>th</sup>, 2023 at 5:30pm

These Minutes are not verbatim.

The Special Town Meeting was called to order at 5:47pm.

**Article 1:** To choose a Moderator to preside at said Special Town Meeting.

Ed MacArthur announced that a Moderator could be chosen by a show of hands with a 2/3 vote.

**Motion** made by Rae Bates to allow a moderator to be chosen by a show of hands. Seconded by Cody Brackett. No discussion heard. **Approved** by majority show of hands.

**Motion** made by Gregg Smallwood to nominate Ed MacArthur to act as the moderator for the Special Town Meeting. Seconded by Kevin Noyes. No discussion heard. **Approved** by majority show of hands.

**Article 2:** To see if the Town will vote to authorize the Select Board, on behalf of the Town, to sign a Resolution in support of Wolfden Resource Corporation Pickett Mountain Mine and Associated Facilities.

**Motion** made by Gregg Smallwood to authorize the Select Board, on behalf of the Town, to sign a Resolution in support of Wolfden Resource Corporation Pickett Mountain Mine and Associated Facilities. Seconded by Rebecca Phillips. A letter from Susan Adams was read by Rae Bates. The letter is attached to these Minutes. **Approved 75:46** by written ballot.

**Article 3:** To see if the Town will vote to approve the Solar Energy Systems Ordinance.

**Motion** made by Gregg Smallwood to approve the Solar Energy Systems Ordinance. Seconded by Cody Brackett. No discussion heard. **Approved** by majority show of hands.

**Meeting adjourned at 6:18pm.**

## Letter from Susan Adams

“I am a resident of Patten and would like to express my thoughts on this resolution to support Wolfden Mining and their most recent efforts just north of Patten.

Putting industrial metal mining above our quality of life up here in Patten and the other surrounding communities would be a grave mistake with no thought of our future generations and its potential future residents.

Clean water is life and something that every single one of us needs and deserves.

I grew up downriver of multiple industries placed along the Penobscot River ,who back 100 years ago put industry above quality of life. It got to the point where my parents could not allow us to go swimming and the fishermen disappeared from my beautiful Penobscot Bay. I doubt anyone predicted this sort of future for the bay back then.

I have visited the headwaters of this very section of the Mattawamkeag River that would be at risk with my son. We paddled the ponds and explored below the old stone dam. Isolated and beautiful , wildlife was plentiful, the lakes and rivers clean and clear, definitely class A nurseries for native brook trout and land locked salmon. I urge you to take the time to go see this for yourselves, in case you decide to support this type of mining , so you can describe to your great grandchildren what it “used to be like”. When I heard about Wolfden’s first application, I educated myself to the facts, like when exposed, sulfide deposits or tailings to oxygen and water, form sulfuric acid, they can leach heavy metals like lead, arsenic, and mercury from the surrounding rock. These amazing fisheries could be threatened by this toxic byproduct, known as acid mine drainage. Are we prepared to leave to our grandchildren streams and lakes like this, destroying the fisheries? How will it affect our neighbors downstream ?

I sat in on the very early LUPC discussions when this project was first proposed. I sent them my letter of concern way back then.

I have seen first-hand the bright, orange-colored streams in rural West Virginia, but I never imagined Mainers could risk this happening here.

Yesterday I had the opportunity to discuss Patten with the economic director of the town of Rumford. He urged me to tell you all to really think about the future . Industry should not affect quality of life, but it often and inevitably can if we are not constantly vigilant, and we don’t do our homework. He said several times, “tell them how vital clean water is to their quality of life “and to please take the time to educate themselves on their own, not through Wolfden.”

Please Vote NO for this unnecessary resolution and think about asking the Patten planning board to draft an ordinance to protect our wells and watersheds from an industrial metal mining disaster in the future. If I could be there, I would be voting no to this resolution and am praying that the majority of you consider doing the same.

Thank you,  
Susan Adams  
Resident of Patten”

Meeting Minutes for Thursday, April 13<sup>th</sup>, 2023.  
Respectfully submitted by,

Laura A. White  
Deputy Town Clerk  
Town of Patten

Minutes approved on June 13, 2023

<u>Cody A B</u>	Chairman Cody Brackett
<u>Gregg Smallwood</u>	Vice Chair Gregg Smallwood
<u>- Absent -</u>	Dennis Kelly
<u>Rae Bates</u>	Rae Bates
<u>Janice Dancer</u>	Janice Dancer



# **EXHIBIT H**

**RESOLUTION IN SUPPORT OF WOLF DEN RESOURCES CORPORATION'S  
PICKETT MT. MINE AND ASSOCIATED FACILITIES**

WHEREAS, Wolfden Resources Corporation ("Wolfden") has proposed development of an underground mine in the unorganized township of T6 R6 in Penobscot County, Maine (the "Mine");

WHEREAS, Wolfden intends to locate associated mine facilities, including a proposed concentrator plant, water treatment plant, dry stack tailings, and potential solar power, in a community proximate to the Mine (collectively the "Associated Facilities"); but outside of the town of Sherman;

WHEREAS, the Maine Department of Environmental Protection ("DEP") has a comprehensive set of regulations that govern the siting, construction, operation, closure and post closure of the Mine and Associated Facilities ("Chapter 200 Regulations");

WHEREAS, the Chapter 200 Regulations ensure that any Mine and Associated Facilities will be fully protective of public health, safety, and the environment;

WHEREAS, the DEP regulation and oversight of the Associated Facilities is comprehensive and addresses all the local impacts that might be of concern to the Town of Sherman;

WHEREAS, the Town of Sherman recognizes the significant local, regional, and state-wide economic benefits associated with development of the Mine and Associated Facilities;

NOW, THEREFORE, BE IT RESOLVED, that the residents of the Town of Sherman support the process of Wolfden undergoing a permit application under Chapter 200 for a mining project with associated facilities, and the future opportunity for a responsible operation in the region under those Chapter 200 Regulations.

Dated at Sherman, Maine April 04, 2023

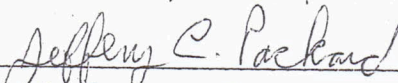
  
\_\_\_\_\_  
Jeffery C. Packard, Selectman

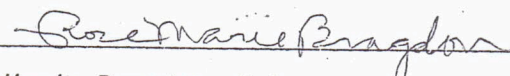
  
\_\_\_\_\_  
RoseMarie Bragdon, Selectman

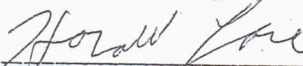
  
\_\_\_\_\_  
Harold A. Lane, Selectman

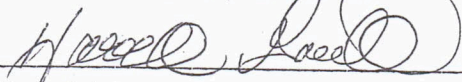
  
\_\_\_\_\_  
Harold R. Gould, Jr., Selectman

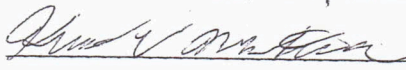
  
\_\_\_\_\_  
Keith W. Mitchell, Sr., Selectman

Attest:  
a True Copy  
Debra J. O'Loach  
Town Clerk

# **EXHIBIT I**

RESOLUTION IN SUPPORT OF WOLFDEN RESOURCE CORPORATION  
PICKETT MT. MINE AND ASSOCIATED FACILITIES

WHEREAS, Wolfden Resources has proposed development of an underground mine in the unorganized township of T6 R6 in Penobscot County, Maine (the "Mine");

WHEREAS, Wolfden Resources Corporation ("Wolfden") intends to locate associated mine facilities, including a proposed concentrator plant, water treatment plant, dry stack tailings, and potential solar power, in a community proximate to the Mine (collectively the "Associated Facilities");

WHEREAS, the Maine Department of Environmental Protection (DEP) has a comprehensive set of regulations that govern the siting, construction, operation, closure, and post closure of the Mine and Associated Facilities ("Chapter 200 Regulations");

WHEREAS, the Chapter 200 Regulations ensure that any Mine and Associated Facilities will be fully protective of the public health, safety, and the environment;

WHEREAS, the DEP regulation and oversight of the Associated Facilities is comprehensive and addresses all the local impacts that might be of concern to the Town of Stacyville;

WHEREAS, the Town of Stacyville does not currently have zoning or site review land use ordinances and does not seek to develop or adopt such ordinances, including to regulate any Mine and Associated Facilities;

WHEREAS, the Town of Stacyville recognizes the significant local, regional, and state-wide economic benefits associated with development of the Mine and Associated Facilities;

WHEREAS, the Town of Stacyville has existing industrial facilities and infrastructure and seeks additional compatible development;

WHEREAS, the Town of Stacyville would like the Associated Facilities to be located in the Town of Stacyville;

NOW, THEREFORE, BE IT RESOLVED, that the residents of the Town of Stacyville strongly support Wolfden and its proposed Mine and Associated Facilities;

BE IT FURTHER RESOLVED, that the residents of the Town of Stacyville strongly encourage Wolfden to locate its Associated Facilities in Stacyville, Maine.

Signed: January 18, 2023

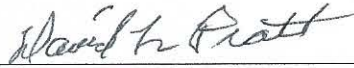

David L. Pratt, Chairman

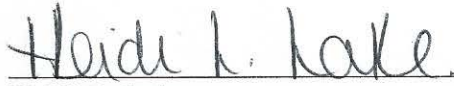

Heidi L. Lake

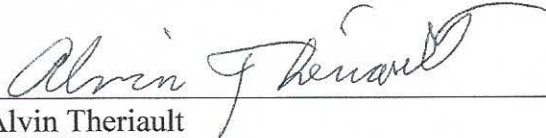

Alvin Theriault



## **EXHIBIT J**

# MORO PLANTATION

21 Katahdin Street | PO Box 542 | Patten, ME 04765

Phone: 207.528.2215 | Fax: 207.528.2055

Website: [www.pattenmaine.org](http://www.pattenmaine.org)

---

## SPECIAL TOWN MEETING

**Wednesday, December 14<sup>th</sup>, 2022 at 5:30pm**  
**Katahdin Lodge, 626 Aroostook Scenic Highway**  
**Moro Plantation, ME 04780**

### MEETING MINUTES

These minutes are not verbatim

Chairman Chuck Loucka called the meeting to order at 5:30pm.

#### ROLL CALL

**Selectmen:** Charles “Chuck” Loucka, Christine “Chris” Loucka, Caralyn "Cara" Loucka King

**Town Office:** Laura White (Moro Agent), Rebecca Phillips (Finance Director)

**Public:** Joseph King, Irene Gerow, Dan Morse, Christopher Streinz (of Hersey), Jeremy Ouellette (of Wolfden), Leah Page (of Wolfden)

**Article I:** To choose a Moderator to preside at said Special Town Meeting.

**Motion** made by Chuck to nominate Christopher Streinz as Moderator of the Special Town Meeting. Seconded by Christine. All in favor. Approved 6:0.

**Article II:** To see if the Plantation will vote to authorize the Select Board, on behalf of the Plantation, to sign a resolution in support of Wolfden Resource Corporation Pickett Mountain Mine and Associated Facilities.

Chuck stated he would like the word “strongly” taken out of the Resolution.

Residents stated they were not informed about the resolution. R. Phillips stated the resolution was posted on the website, at the Patten Post Office, Katahdin Trust Company, and Ellis’s Market in Patten. Chuck stated it was posted on the FaceBook page.

Irene stated she heard it does not matter how they vote, the mining will happen with or without the Plantation’s support. J. Ouellette stated it is the company’s focus to be transparent with local communities and to address any concerns residents might have. He added that Wolfden made an effort to reach out to residents by going door-to-door to invite them to the informational session held by the Moro Board of Assessors a few weeks prior to the Special Town Meeting.

C. Streinz read the proposed resolution.

J. Ouellette gave a presentation on the proposed mining project and answered questions from residents.

A statement from Brian Burger was read by L. White.

Irene and D. Morse stated they agreed with points made in the statement from Mr. Burger. J. Ouellette stated he did not agree with Mr. Burger's point about blank checks. Irene agreed with Mr. Ouellette. J. Ouellette stated Wolfden will be investing \$20 million on the entire process and wants to be sure the surrounding communities are not going to oppose the project after they meet the requirements in Chapter 200. C. Streinz stated the proposed resolution does not use that language. Mr. Streinz added that the resolution states the Plantation supports Wolfden and its proposed Mine and Associated Facilities, not the process or Chapter 200 of the DEP, and that the resolution is similar to what Mr. Burger was opposed to. J. Ouellette stated Wolfden was not opposed to changing the language in the resolution to align better with what was being discussed during the meeting. Irene stated she did not feel she had enough information to vote at this time. C. Streinz suggested tabling the vote on the resolution until after another informational meeting could be held. The Board of Assessors stated concerns about poor attendance at meetings in the Plantation. Caralyn stated this was the third meeting regarding the mining project. Irene stated, if the Board of Assessors were voting to support the resolution, she felt her vote in opposition would not matter. Caralyn stated residents have not reached out to the Board, or to Wolfden, with questions. D. Morse asked for clarification as to what "support" means. J. Ouellette stated, if there is no community support, Wolfden probably would not continue as the State agencies would not support the project. He stated, if the feedback from the community is mostly positive, and only one or two towns are not interested, the Department of Environmental Protection (DEP) would at least process their permit application. Mr. Ouellette stated it was important that they have the support of the local communities. D. Morse stated concerns about fishing being negatively impacted by the mining operation, but understands why a business that rents rooms would be in favor of the resolution. Caralyn stated this is not the only reason they are in favor, that it would bring people into the area and help gain tax money for the Plantation.

The Plantation discussed the wording of the proposed resolution.

C. Streinz suggested changing the last sentence of the proposed resolution. The proposed sentence stated, "NOW, THEREFORE, BE IT RESOLVED, that the residents of the Town of Moro Plantation ~~strongly~~ support Wolden and its proposed Mine and Associated Facilities;" Mr. Streinz suggested having it instead state, "NOW, THEREFORE, BE IT RESOLVED, that the residents of the Town of Moro Plantation support the process of Wolfden exploring whether they can meet or exceed the Maine Chapter 200 Law in the Pickett Mountain Project."

D. Morse stated his support for the amendment to the proposed resolution.

**Motion** made by J. King to approve Article II with the above amendments. Seconded by Caralyn. Discussion: Irene asked for clarification that the vote was for the resolution and not just the amendment. C. Streinz stated the vote was for the resolution with amendments. Approved 5:1. Five (5) in support, one opposed. Vote from Brian Burger is not counted, as residents may not vote by proxy.

## **ADJOURN**

**Motion** made by Irene to adjourn at 6:48pm. Seconded by Chuck. All in favor. Approved 6/0/0.

Meeting Minutes for Wednesday, December 14<sup>th</sup>, 2022 respectfully submitted by,

Laura A. White  
Deputy Town Clerk, Moro Town Agent  
Town of Patten / Moro Plantation

**The original resolution, as well as the revised and signed resolution, and statement from Brian Burger are attached to these Minutes.**

Minutes approved on February 15, 2023



Charles Loucka, Chairman

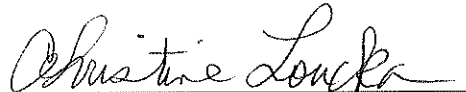

Christine Loucka

Caralyn Loucka King



To the people of Moro Plantation and it's elected leadership,

It is not possible for me to attend the Moro Plantation public meeting on 14 December 2022 proposed to consider a resolution to support Wolfden Resources Corporation in its Pickett Mountain project.

I am requesting that this commentary be read openly in the meeting's public comments and my vote recorded accordingly.

I am not wholesaley opposed to the company of Wolfden or its proposal, but I do have concerns that can only be conveyed by a **vote in opposition to a resolution of support**. I am therefore requesting my vote of opposition be recorded and accounted for in the public record.

While I can appreciate the present effort of Wolfden to collect evidence of public interest and support.. at this point in time.. resolutions and even more so, ordinances, seem out of order in the public interest. From the public view.. this is the proverbial cart before the horse. Essentially, Wolfden is seeking blank checks from the community for an invoice that has no known itemization or total.. and no warranty.

Natural resource extraction is an endeavor not merely for ourselves but for generations well past our lives and beyond the lives of anyone presently in existence. This is long-term beyond more than most folks can imagine.

What does have impact to those currently breathing on this planet, and in our community, includes lofty finances and the good and bad in present day activities. It seems that the majority are fixated on glamorous promises of wealth both directly and indirectly. Frankly, resource exploitation counts on that precise condition.

Moro residents must understand the likelihood of very-near processing and waste activities. I suggest this because of the site location and the costs to the mining entity to locate such activities any farther than necessary from the extraction site and ultimate shipping location. The likely location of 24/7 processing with noise, light, particulate and chemical influences is obviously as near as possible to the Pleasant Lake / Route 11 intersection in Hersey. Even if the mining itself operates perfectly, this is an issue. I lived this before.

Many persons in Moro Plantation may easily say this is someone else's problem. I propose that the communities of the greater Patten area are collectively one community which will benefit or damage one another far and wide.

I suggest that our community respectfully wish Wolfden well in its endeavors and suggest they pursue the existing and established order of applications required and recognized in our State of Maine. Blank checks are just not good business or good governance.

My vote is opposed to a Moro Plantation resolution of support on the Wolfden - Pickett Mountain proposal at this time.

Respectfully to all,

Brian B. Burger  
33 S Mill Brook Rd  
Moro Plantation, ME 04780-6060

**RESOLUTION IN SUPPORT OF WOLFDEN RESOURCES CORPORATION'S  
PICKETT MT. MINE AND ASSOCIATED FACILITIES**

WHEREAS, Wolfden Resources Corporation ("Wolfden") has proposed development of an underground mine in the unorganized township of T6 R6 in Penobscot County, Maine (the "Mine");

WHEREAS, Wolfden intends to locate associated mine facilities, including a proposed concentrator plant, water treatment plant, dry stack tailings, and potential solar power, in a community proximate to the Mine (collectively the "Associated Facilities"); but outside of the town of Moro Plantation;

WHEREAS, the Maine Department of Environmental Protection ("DEP") has a comprehensive set of regulations that govern the siting, construction, operation, closure and post closure of the Mine and Associated Facilities ("Chapter 200 Regulations");

WHEREAS, the Chapter 200 Regulations ensure that any Mine and Associated Facilities will be fully protective of public health, safety, and the environment;

WHEREAS, the DEP regulation and oversight of the Associated Facilities is comprehensive and addresses all the local impacts that might be of concern to the Town of Moro Plantation;

WHEREAS, the Town of Moro Plantation recognizes the significant local, regional, and state-wide economic benefits associated with development of the Mine and Associated Facilities;

NOW, THEREFORE, BE IT RESOLVED, that the residents of the Town of Moro Plantation strongly support Wolfden and its proposed Mine and Associated Facilities;

**RESOLUTION IN SUPPORT OF WOLF DEN RESOURCES CORPORATION'S  
PICKETT MT. MINE AND ASSOCIATED FACILITIES**

WHEREAS, Wolfden Resources Corporation ("Wolfden") has proposed development of an underground mine in the unorganized township of T6 R6 in Penobscot County, Maine (the "Mine");

WHEREAS, Wolfden intends to locate associated mine facilities, including a proposed concentrator plant, water treatment plant, dry stack tailings, and potential solar power, in a community proximate to the Mine (collectively the "Associated Facilities"); but outside of the town of Moro Plantation;

WHEREAS, the Maine Department of Environmental Protection ("DEP") has a comprehensive set of regulations that govern the siting, construction, operation, closure and post closure of the Mine and Associated Facilities ("Chapter 200 Regulations");

WHEREAS, the Chapter 200 Regulations ensure that any Mine and Associated Facilities will be fully protective of public health, safety, and the environment;

WHEREAS, the DEP regulation and oversight of the Associated Facilities is comprehensive and addresses all the local impacts that might be of concern to the Town of Moro Plantation;

WHEREAS, the Town of Moro Plantation recognizes the significant local, regional, and state-wide economic benefits associated with development of the Mine and Associated Facilities;

NOW, THEREFORE, BE IT RESOLVED, that the residents of the Town of Moro Plantation ~~strongly support Wolfden and its proposed Mine and Associated Facilities;~~

↓  
SUPPORT THE PROCESS OF WOLF DEN EXAMINING  
THE  
WHETHER THEY CAN MEET OR EXCEED ANY OF THE  
LAW AS THE MINE PROJECT  
IN THE PICKETT

**RESOLUTION IN SUPPORT OF WOLFDEN RESOURCES CORPORATION'S  
PICKETT MT. MINE AND ASSOCIATED FACILITIES**

WHEREAS, Wolfden Resources Corporation ("Wolfden") has proposed development of an underground mine in the unorganized township of T6 R6 in Penobscot County, Maine (the "Mine");

WHEREAS, Wolfden intends to locate associated mine facilities, including a proposed concentrator plant, water treatment plant, dry stack tailings, and potential solar power, in a community proximate to the Mine (collectively the "Associated Facilities"); but outside of the town of Moro Plantation;

WHEREAS, the Maine Department of Environmental Protection ("DEP") has a comprehensive set of regulations that govern the siting, construction, operation, closure and post closure of the Mine and Associated Facilities ("Chapter 200 Regulations");

WHEREAS, the Chapter 200 Regulations ensure that any Mine and Associated Facilities will be fully protective of public health, safety, and the environment;

WHEREAS, the DEP regulation and oversight of the Associated Facilities is comprehensive and addresses all the local impacts that might be of concern to the Town of Moro Plantation;

WHEREAS, the Town of Moro Plantation recognizes the significant local, regional, and state-wide economic benefits associated with development of the Mine and Associated Facilities;

NOW, THEREFORE, BE IT RESOLVED, that the residents of the Town of Moro Plantation support the process of Wolfden exploring whether they can meet, or exceed, the Maine Chapter 200 Law in the Pickett Mountain Project.

Signed: December 20, 2022



Charles Loucka

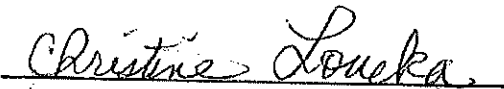

Christine Loucka

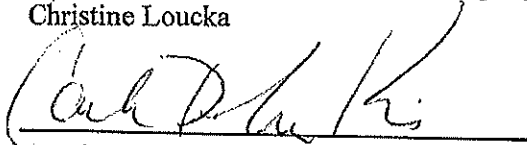

Caralyn Loucka King



# **EXHIBIT K**

**Tribal Historic Preservation Office**  
**Passamaquoddy Tribe**  
PO Box 159 Princeton, Me. 04668  
207-214-4051

May 9, 2023

State of Maine  
Land Use Planning Commission  
18 Elkins Lane  
Augusta, Maine 04333

Re: Pickett Mountain Mine Rezoning Application, ZP 779A – Wolfden Mt. Chase LLC

Dear Stacie;

The Passamaquoddy THPO has reviewed the following applications regarding the historic properties and significant religious and cultural properties in accordance with NHPA, NEPA, AIRFA, NAGPRA, ARPA, Executive Order 13007 Indian Sacred Sites, Executive Order 13175 Consultation and Coordination with Indian Tribal Governments, and Executive Order 12898 Environmental Justice.

**The Project listed above will need a detailed archeological survey of the project footprint and on any new road construction.** We recommend a qualified archeologist review this proposal and conduct a ground survey. **One of the problems we have seen over the years is that dust** from a mining operation does impact water and surrounding land which can have any impact on cultural and historical concerns of the Passamaquoddy Tribe. Should buried artifacts, human remains, cultural sites or ground features be unexpectedly unearthed during ground disturbing activities, all construction should immediately cease and the resources be examined by a professional archaeologist. Additionally, all appropriate authorities-including all pertinent tribal entities should be notified.

Sincerely;

Donald Soctomah  
Soctomah@gmail.com  
THPO  
Passamaquoddy Tribe

# **EXHIBIT L**

---

---

## INTERDEPARTMENTAL MEMORANDUM

MAINE GEOLOGICAL SURVEY, DEPARTMENT OF AGRICULTURE, CONSERVATION  
AND FORESTRY

93 STATE HOUSE STATION, AUGUSTA, ME 04333-0093, (207) 287-2801

---

---

**DATE:** 06/15/2023  
**TO:** TIM CARR, SENIOR PLANNER, LUPC  
**CC:** HENRY N. BERRY, IV, SENIOR GEOLOGIST; RYAN GORDON, HYDROGEOLOGIST  
**FROM:** STEPHEN M. DICKSON, PH.D., STATE GEOLOGIST, MGS  
**RE:** REZONING FOR THE PICKETT MOUNTAIN METALLIC MINE, T6 R6 WELS, PENOBSCOT COUNTY

---

After a review of the above project, as presented to us, and consideration of our agency's standards, programs, and responsibilities, the following comments are submitted to the Land Use Planning Commission.

Staff of the Maine Geological Survey (MGS) reviewed parts of the application by Wolfden Mount Chase LLC to the Land Use Planning Commission (LUPC) to rezone parts of T6 R6 WELS as a Planned Development subdistrict for the purposes of permitting and operating an underground polymetallic mine. The documents reviewed included sections of the Application prepared by Stantec Consulting Services Inc., dated January 18, 2023, and the Response to LUPC Comments of February 24, 2023, dated April 13, 2023.

The focus of the MGS review was on the size of the rezone area, the completeness of the mine facilities, the logistics of the surface operation, and potential impacts to natural resources, including water resources. As such, the entire application was not read or reviewed by MGS staff. MGS specifically reviewed the following sections from the January 18, 2023 application:

1. Executive Summary
2. Exhibits 1-2
3. Exhibit 6.1
4. Exhibits 7-8
5. Exhibit 10
6. Exhibits 24-25

plus, the answers in the Response to LUPC Comments of February 24, 2023 document, including Attachments A and B.



## **Appropriateness of New District Designation**

One of the criteria for approval of a zone change petition is whether the new designation is more appropriate for the management of existing resources in the affected area [LUPC Chapter 12 Rules, Section 4B (1)(b)]. Environmentally responsible mining of metallic mineral resources is a goal of the CLUP, as the Application mentions. We would add that there are currently very few mineral deposits in Maine known to be of significant size and grade (see Metallic Mineral Deposits of Maine <https://www.maine.gov/dacf/mgs/explore/mining/metal.pdf>). Of those few, the Pickett Mountain polymetallic deposit stands out as most compatible with the objectives of the Maine Metallic Minerals Mining Act (MMMMMA) which favors small, high-grade deposits that can be mined underground, having less potential environmental impact than large, low-grade, surface mines. Also, one of the commodities in the deposit, zinc, is on the federal list of critical minerals, essential to the economic and national security of the United States. Therefore, in our view, it would be more appropriate management of the metallic mineral deposit to allow it to proceed to the permitting process as envisioned by the CLUP and regulated by the MMMMA, than to have it remain in the M-GM zone.

## **Size of Rezone Area**

In response to the LUPC guidance (Chapter 12 Rules, Section 3) that the size of the Subdistrict "... shall be limited to an area necessary to reasonably conduct authorized mining ..." we observe that the proposed rezone area fits closely around the features shown on the conceptual plan (Figure 2-1). While the plan as proposed does fit within this footprint, we encourage the Commission to consider allowing the applicant and the DEP some room for alternative designs that might be indicated during the permitting process as more detailed information is obtained. Specifically, we note that detailed soils information and engineering designs could require adjustments in the positioning of certain features. It might be preferable at the zoning stage to allow enough space for the regulators to work than to require the applicant to return for an amendment. This is simply a matter of contingency as would be encountered in any major construction project. It is challenging to know exactly what area is "necessary" before there is an "authorized" mining project.

The specific areas that we see where the existing boundary might need to be expanded slightly to allow redesign as more detailed information becomes available in the permitting process are:

1. At the southwest corner of the rezone area. The Organics Storage (26) is pressed against the western boundary of the rezone area. As currently designed, this is acceptable. However, as shown on Figure 2-6, Section G, there is not much space between the Organics Storage (26) and the excavation for Waste Rock Pad #2 (30). If the soils or engineering studies show that a more gradual slope is required for the west side of the

waste rock pad excavation, the DEP might ask for the Organics Storage to be moved uphill, for example.

2. At the south edge of the rezone area, a Proposed Access Road is shown on the Conceptual Site Plan (Figure 2-1) leading south from Waste Rock Storage Pad #2 (30). This access road appears to make an unreasonably sharp left turn onto the existing gravel road leading to the northeastern part of the site. Is there adequate space there to accommodate this turn reasonably and safely in the current footprint without affecting the wetland area?
3. The northeast boundary of the rezone area, where the Security Guard Gatehouse (36) is located. We have some questions about the layout of the site area between the Mine Portal (24) and the Snow Storage Area (3). Any adjustments or additional structures in this area that might be indicated during the permitting process could require moving the northeastern boundary slightly to the northeast.

### **Site Facilities and Operations**

The features of the site and their arrangement overall are well laid out, efficient, and logical. They have been situated well in consideration of the topography and wetland areas. The phased plan using a hoist to access the southwestern ore body is creative. That said, there are some details that we don't see in the conceptual plan.

1. How does waste rock get from the backfill plant to the mine portal? We don't see an access road to the backfill plant. On Figure 2-5, Section F the backfill plant is not shown. From that section it would appear to be 10 feet higher than the access road.
2. Is there a facility on site where mine waste testing and characterization will take place? If not, does it need to be added?
3. How will the backfill material be "neutralized or otherwise treated to prevent contamination of groundwater," as required by DEP Chapter 200 Rules?
4. How and where will ore be loaded into the semi-tractor trailer dump trucks, from both ore pads?
5. Is there a truck scales for weighing loads of ore leaving the site?
6. There is an existing gravel road within the rezone area between the northeast and southwest operations areas. This road passes through a wetland area. What is the condition of this road? It appears to be the primary route of loaded ore trucks from Ore Storage Pad #2 (29) to the off-site processing facility. If it needs improvement, will it require a NRPA permit?

## Impacts to Water Quantity

The analysis of area hydrology and the general water balance of the site (Exhibit 10.5.2 and Table 10-1) appears to be sufficient. The precipitation and runoff modeling presented in Attachment 10-C also appears sufficient and reasonable. Furthermore, the two reports by Sevee & Maher Engineers (Attachment 10-E to the application and Attachment B to the Response to LUPC Comments of February 24, 2023) concerning spray irrigation, snowmaking, and changes to water flow timing and quantity all appear to be well-considered. On the other hand, we would like to see more discussion and details about anticipated uses and sources of water in the project area. In Attachment 10-C and in the Sevee & Maher reports, the combined wastewater volume resulting from mine dewatering and mining operations is estimated at 30 gallons per minute (15.8 million gallons per year); however, details about this estimate are lacking. Specifically, we have the following questions about this estimate and other uses and sources of water:

1. How much of the estimated 15.8 MGY would be from groundwater infiltration into the mine, and how much from mining operations? How was the volume of groundwater infiltration estimated, and what is the reasonable range or uncertainty for this estimate?
2. What is the volume of water anticipated to be used for the mining operations, and how was this estimate made? What are the anticipated uses of water in the underground workings? Potential water uses that are not thoroughly discussed include:
  - a. drilling and excavation
  - b. underground dust control
  - c. underground equipment and vehicle washing
3. Further uses of water on the surface and elsewhere on site are not considered at all in the potential volume of water requiring treatment. Would these constitute significant volumes, and are the water treatment systems sized appropriately to include any of these potential uses? Additional potential uses include:
  - a. fire suppression
  - b. surface dust control
  - c. washing of paved surfaces
  - d. washing of transport trucks
  - e. exploration drilling
4. Might the fire suppression system use PFAS or other chemical flame retardants, and is the water treatment system able to remove these substances if there is a use of the fire suppression system anywhere in the mine or on the development site?
5. What are the anticipated sources of water to be used on-site and where will they be located? A potable water well is briefly mentioned for use in staff washrooms, but not located on the site plan, but the source of mining water is not described at all or located on the plan.

## **Impacts to Water Quality**

The general design of contact water treatment (holding ponds, treatment works, and treated water disposal), as described in Attachment 10-D, appears well-considered and appropriate, as long as they are designed for the appropriate volume of water produced (see questions on water uses above). However, the design of contact water collection is lacking in some details. For example, the ore and waste rock storage pads are proposed to have engineered liner and leachate collection systems that are described in some detail (Exhibit 2 and figures), but the design of water collection from other infrastructure within the “water collection area” shown on Figure 2-1 is not described. Specifically, we have the following questions:

1. Will the snow storage area be underlain by an engineered liner and leachate collection system similar to the ore and waste rock storage pads?
2. What methods will be used to reduce or eliminate the infiltration of contact water through roads, lots, ditches, etc., that are not designed with liners within the “water collection area”?
3. How will water be collected from other surfaces and structures within the “water collection area,” including road ditches, lots, and buildings such as the maintenance shop, equipment fueling, backfill plant, etc.?
4. From the standpoint of potential environmental impact, we would assign all water in the rezone area to either contact water or non-contact water. We consider the water in the “water collection area” to be contact water because it has been exposed to mine truck traffic, backfill processing, and loading or unloading ore or waste rock. Are there areas where ore or waste rock will be loaded or unloaded that are outside the “water collection areas” indicated on the conceptual site plan (Figure 2-1)?

## **Miscellaneous Questions**

1. Exhibit 6.1.9 shows a bedrock map taken from the 1:500,000 Bedrock Geologic Map of Maine. There is a more detailed 1:62,500 scale map available from the U.S. Geological Survey (Ekren and Frischknecht, 1967). This is a technical point, but not a significant issue, since the applicant has conducted more recent detailed bedrock mapping as presented in Figure 7.4 of the Preliminary Economic Assessment.
2. Attachment 10-B reports the results of seven samples that were analyzed for acid-generating potential. What are the locations of the samples?
3. What will become of the Low-Grade Ore?



STATE OF MAINE  
DEPARTMENT OF AGRICULTURE, CONSERVATION & FORESTRY  
LAND USE PLANNING COMMISSION

IN THE MATTER OF )  
REZONING PETITION ZP 779A ) PRE-FILED DIRECT TESTIMONY  
WOLFDEN MT. CHASE, LLC ) OF WOLFDEN MOUNT CHASE, LLC

VOLUME II OF IV  
(Testimony of Mark Peters, Brian Danyliw & Paul Thoen, Lisa Turner, Jim Finley, Don Dudek)

## **INDEX OF WITNESSES AND EXHIBITS**

### **VOLUME I**

#### **JEREMY OUELLETTE**

Pre-Filed Direct Testimony

- Exhibit A Chapter 200 Summary
- Exhibit B Statements from CLF and NRCM on Maine’s mining law
- Exhibit C Figure 2-1 conceptual site plan
- Exhibit D LUPC Guidance for Interpreting 2010 CLUP, October 5, 2012
- Exhibit E Summary of Wolfden Community Engagement
- Exhibit F Town of Hersey Mining Ordinance and Special Town Minutes from October 6, 2022
- Exhibit G Town of Patten – Special Town Meeting Minutes, April 13, 2023
- Exhibit H Town of Sherman – Resolution in Support of Wolfden Resources, April 4, 2023
- Exhibit I Town of Stacyville – Resolution in Support of Wolfden Resources, January 18, 2023
- Exhibit J Moro Plantation – Special Town Meeting Minutes, December 14, 2022
- Exhibit K Passamaquoddy THPO Comments to LUPC
- Exhibit L Maine Geological Survey Comments to LUPC

#### **DOUGLAS STEWART**

Pre-Filed Direct Testimony

- Exhibit A Curriculum Vitae
- Exhibit B Wolfden Regional Location Map
- Exhibit C Penobscot River Watershed Map
- Exhibit D Correspondence with MDIFW, September 25, 2023

#### **GEMMA-JAYNE HUDGELL**

Pre-Filed Direct Testimony

- Exhibit A Curriculum Vitae
- Exhibit B Northeast Archaeological Research Center Archaeological Phase 0 Assessment

### **VOLUME II**

#### **MARK PETERS**

Pre-Filed Direct Testimony

- Exhibit A Curriculum Vitae
- Exhibit B Wood (now WSP) Technical Memorandum

#### **BRIAN DANYLIW & PAUL THOEN**

Pre-Filed Direct Testimony

- Exhibit A Curriculum Vitae Danyliw

Exhibit B Curriculum Vitae Thoen  
Exhibit C Mine Water Service Water Treatment Report

**LISA TURNER**

Pre-Filed Direct Testimony

Exhibit A Curriculum Vitae  
Exhibit B Sevee & Maher Engineers Technical Memorandum, December 19, 2022  
Exhibit C Sevee & Maher Engineers Response to LUPC Comments, April 12, 2023  
Exhibit D Spray Irrigation Systems and Equipment  
Exhibit E Snowmaking Systems and Equipment

**JIM FINLEY**

Pre-Filed Direct Testimony

Exhibit A Curriculum Vitae

**DON DUDEK**

Pre-Filed Direct Testimony

**VOLUME III**

**RONALD LITTLE**

Pre-Filed Direct Testimony

**BRIAN LeBLANC**

Pre-Filed Direct Testimony

Exhibit A Curriculum Vitae  
Exhibit B Overview of AMPL  
Exhibit C Preliminary Economic Assessment Cover Page and Table of Contents

**SEAN FIELER**

Pre-Filed Direct Testimony

**VOLUME IV**

**MICHAEL LeVERT**

Pre-Filed Direct Testimony

Exhibit A Curriculum Vitae  
Exhibit B Economic Assessment of the Proposed Project, November, 2022

**TERRY THURSTON-HILL**

Pre-Filed Direct Testimony

STATE OF MAINE  
DEPARTMENT OF AGRICULTURE, CONSERVATION & FORESTRY  
LAND USE PLANNING COMMISSION

IN THE MATTER OF	)	Pre-Filed Direct Testimony of Brian
REZONING PETITION ZP 779A	)	Danyliw and Paul Thoen on Behalf of
WOLFDEN MT. CHASE, LLC	)	Wolfden Mt. Chase, LLC

On behalf of Wolfden Mt. Chase, LLC (“Wolfden”), Brian Danyliw and Paul Thoen are submitting this pre-filed direct testimony in support of ZP 779A.

**I. QUALIFICATIONS AND EXPERIENCE**

Brian Danyliw is the owner and principal of Mine Water Service Inc. (<https://minewaterservice.com>), a consultancy specializing in water treatment solutions for the mining and mineral processing industries. Brian has 40 years of water treatment and mining and mineral processing experience in North and South America and other international geographies solving many technical problems in precious metals, base metals, iron ore, uranium, alumina, industrial minerals processing and coal preparation operations.

Brian has detailed knowledge of both water treatment requirements as well as mining and mineral processing technologies which allows him to integrate his water treatment knowledge with operational knowledge when developing solutions for mining clients. Water treatment experience and expertise includes effluent treatment, mine water clarification, cyanide destruction, heavy metal removal, remediation, and utilities (boiler & cooling) pretreatment and functional treatments. Included in this experience and knowledge is a detailed understanding of membrane filtration theory and operational experience.

Brian’s curriculum vitae is attached as Exhibit A.



Dr. Paul Thoen is the Chief Technology Officer at Shelton Associates and Separation Technologies (<https://www.sheltonassoc.com/>). Dr. Thoen has over 25 years of experience designing, fabricating, and installing industrial water treatment systems for the mining industry. A well-rounded team leader and manager of engineers, scientists, technicians and mechanics to design and fabricate industrial water and wastewater treatment systems. Excellent communication skills for cultivating and building long term client relationships with diverse, international client base. Areas of expertise include process engineering, water chemistry, industrial water treatment systems, project management, membrane technology, chemical engineering, with extensive experience treating mining wastewater.

Dr. Thoen's curriculum vitae is attached as Exhibit B.

## **II. INVOLVEMENT WITH THE PICKETT MOUNTAIN PROJECT**

Mine Water Services (MWS) was retained by Wolfden to evaluate options for treating surface contact water and underground mine water to meets or exceeds background water quality at the Pickett Mountain site. MWS worked in consultation with Dr. Thoen to develop the treatment methodology and plant design. Their report is included as Attachment 10-D to the application and is attached here as Exhibit C for reference. The key components of the report are summarized below.

## **III. MINE WATER TREATMENT**

As discussed in the application and testimony of Mark Peters, the water management system is designed to capture and collect surface water that has potentially been in contact with mining operations and underground mine water. The collected water is then directed to the on-site water treatment system. After treatment, clean water is discharged back into the environment as described in the pre-filed testimony and report prepared by Sevee & Maher Engineers. The

focus of our testimony is the two-stage water treatment system, which includes (i) membrane filtration utilizing ultrafiltration (UF), which removes suspended solids and other particles down to approximately 0.1 micron in size, and (ii) reverse osmosis (RO), which remove constituents down to their atomic radii in size. Each treatment stage is discussed below.

### A. Ultrafiltration

Ultrafiltration (UF) membrane systems use hollow membranes to remove larger particles, down to approximately 0.1 micron in size. Examples of these particles may include bacteria, viruses, colloidal silica dust, etc. Ceramic membranes, proposed for use here, are essentially hollow tubes constructed of sintered metal (such as aluminum oxide), which results in a porous structure. This porous structure allows the tubes to act as filters, while the sintered metal construction provides durability and strength. Influent water is forced under pressure through the hollow tubes, and then filtrate (clean water) passes through the pore structure of the tube walls and exits the membrane system. The larger particles are prevented from passing through the system. A schematic of the UF membrane system is shown below:

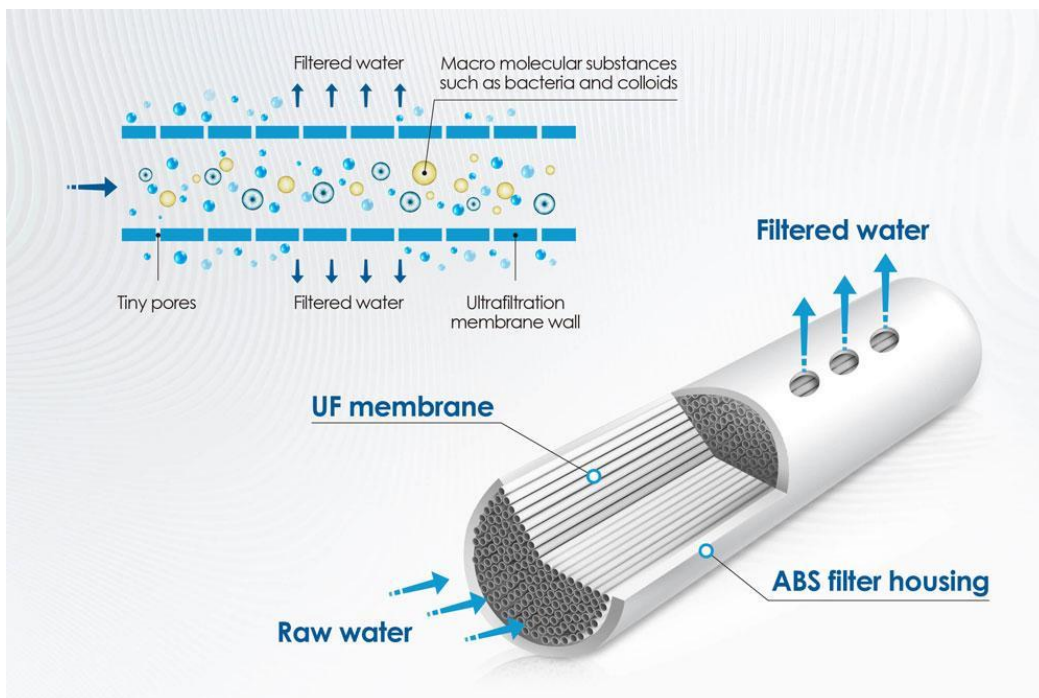

UF systems are used around the world to treat water for public consumption as well as for industrial uses. The global ultrafiltration market was estimated to be \$4.1 billion in 2021<sup>1</sup> with the market distribution as illustrated below.

2

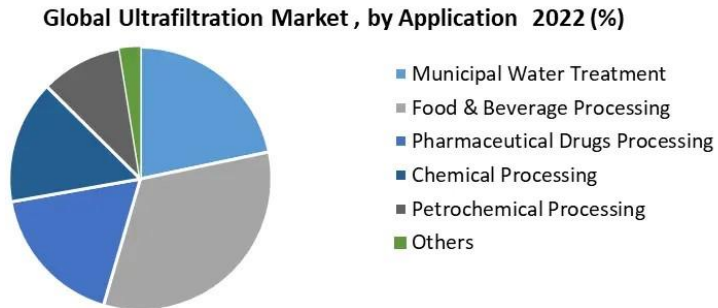

At the Pickett Project, the UF treatment stage will mainly remove fine suspended solids prior to the filtered water reporting to the reverse osmosis membranes.

### **B. Reverse Osmosis**

After the larger particles have been removed, the second treatment stage utilizes reverse osmosis (RO). RO is dependent on and built around individual membranes. In its most simplified terms, RO purifies water by pushing it through a semi-permeable membrane, which removes contaminants in the water. A schematic is shown below:

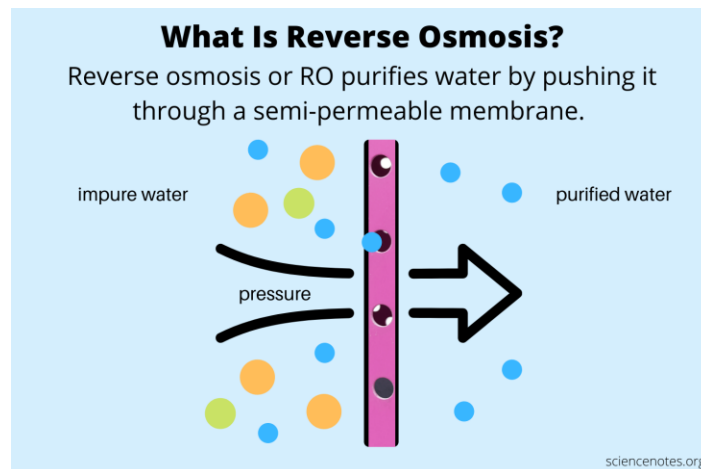

<sup>1</sup> <https://www.emergenresearch.com/industry-report/ultrafiltration-membranes-market>

<sup>2</sup> <https://www.maximizemarketresearch.com/market-report/ultrafiltration-market/165204/>

Here, there will be multiple layers of membrane and supporting material that are formed into a tube. Feed water enters one end of the RO tube; pure water that passes through the membranes is collected and exits the system as permeate (clean water); and the water with impurities that do not pass through the membranes exits the system as wastewater. This is shown schematically below:

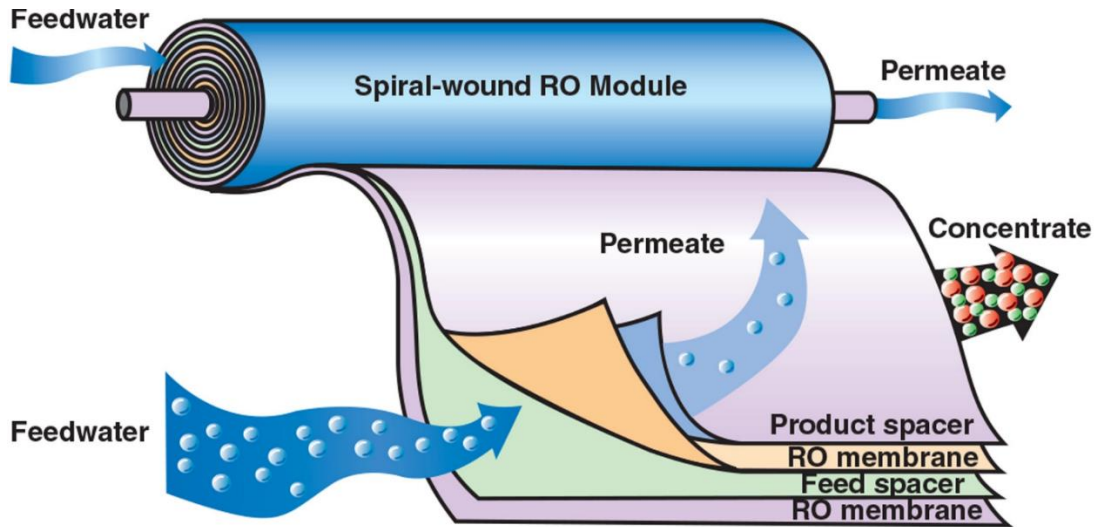

**Source: Ionics Inc.**

**NF—nanofiltration, RO—reverse osmosis**

**Density of dots: highest density—concentrate, medium density—feedwater, lowest density—permeate**

RO represents state of the art technology in water treatment. It was developed in the late 1950's as a method for desalinating sea water. Today, it is used by most water bottling plants, many home water treatment systems, and by many industries that require ultra refined water in manufacturing, such as microelectronics and pharmaceuticals, as well as high quality treated wastewater to meet strict environmental discharge requirements. Reverse osmosis is utilized extensively to treat wastewater prior to discharge to the environment in many industries including mining and mineral processing. It can remove impurities from water and produce water containing only water molecules. In the case of heavy metals and other contaminants that may be

present in the water being treated here, RO can remove all constituents except for some dissolved gases such as oxygen and carbon dioxide (which are not contaminants and are naturally present in all water).

### **C. Treatment of Pickett Mine Water**

Included in my report is a list of the elements and other constituents likely to be present in the water requiring treatment here and their removal efficiency using RO. This information is based on water chemistry data supplied by the Half Mile Mine. While variations are expected due to site-specific mineral deposits, based on my years of experience with water treatment at multiple polymetallic sulfide mining operations, the data from the Half Mile Mine is similar to and provides an appropriate proxy for the Pickett site. Note that the removal efficiency is based on a single pass through a typical RO membrane of the type chosen for this project. Sequential treatment, through a second membrane, will result in additional rejection of the indicated species at the same removal efficiency. Repeated RO passes would result in concentrations of all species in the treated water being below detection limits for testing and would therefore result in essentially pure water containing no dissolved solids. This data demonstrates the ability of these systems to remove contaminants that are likely to be present in the mine water requiring treatment.

In addition to the literature results on treatment efficiencies for typical RO systems, we conducted modeling using four different software packages to evaluate performance of the system based on expected input water quality (as discussed above, it is based on data from the Half Mile Mine) and the target effluent water quality (e.g., to background water quality expected at the site). In all modeling cases a single UF stage was followed by a two-stage RO system to



provide optimal metal and mineral removal. These models demonstrate that the water can be treated to meet background water quality at the site.

The final water treatment system design will reflect the site-specific data to be collected as part of the Chapter 200 process. For example, baseline surveys include two years of water quality monitoring, and those monitoring results will establish the criteria that must be met before treated water can be discharged back into the environment. Likewise, geochemical characterization work (trace element geochemistry, metal leaching, and acid rock drainage) studies will take place utilizing fresh drill core from a planned infill drill program. Those results will provide key information on the water chemistry of the input water and will inform the final design of the treatment system. Final membrane selection and the required number of RO passes will be based on this site-specific data and our experience with similar water treatment systems. Membrane selection will be based on anticipated influent and required treated water quality. It should be noted, however, that the membranes selected at plant start up could be changed, if required, as site conditions develop. The selection of a specific membrane is based on influent and treated water quality requirements while also considering the system operating pressure and the impact of pressure on power demand and hence operating cost. There are a large range of membranes commercially available with varying pore sizes so part of the final design and engineering stage for the RO system will be selection of the optimal membranes.

In conclusion the utilization of UF and RO can produce a treated water quality to whatever water purity is desired by employing the right membranes with enough RO stages. In addition, since RO stages are modular, additional stages can be added at any time to address any changes in plant influent water quality or treated water quality requirements.

### D. Treatment Plant Sizing and Post Treatment Testing

Finally, although the final plant sizing will depend upon the data gathered as part of the Chapter 200 process, we prepared a conceptual facility design to treat 205 USGPM. This sizing is based on the technical memorandum included as Attachment 10-C to the application and discussed by Mark Peters in his pre-filed testimony. The figure below shows the proposed water treatment process flow diagram assuming an input of 205 gpm:

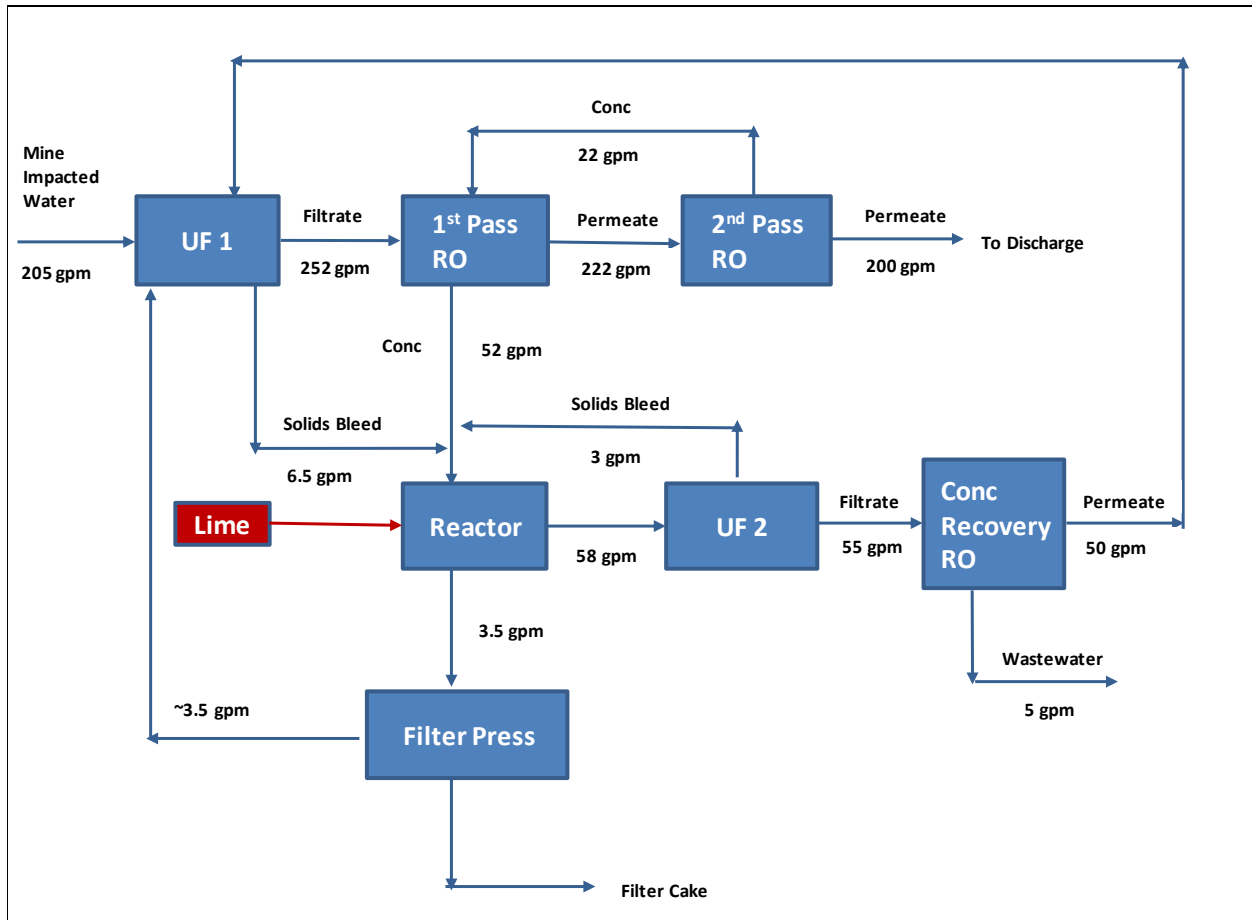

The plant sizing is based on peak flows, but as a modular treatment system it can be easily modified to accommodate any anticipated flow.

Finally, treated water is stored in a Post-Treatment Water Storage Pond and is tested prior to discharge back to the environment. Only after testing confirms that the water meets background

water quality requirements will it be discharged back to the environment. If for any reason it does not meet the discharge criteria it will be returned for further treatment.

Our goal is to provide a water treatment plant design that will allow the Project to meet the strict discharge water quality requirements. Our goal is also to include flexibility through a modular design that will allow easy modification of the plant to meet any changing future requirements.

Dated: Sept. 14, 2023

  
Brian Danyliw

State of Maine  
Cumberland, ss.

Date: 9/14/23

Personally appeared before me the above named Brian Danyliw, who, being duly sworn, did testify that the foregoing testimony was true and correct to the best of his knowledge and belief.

Before me,  
  
Notary Public  
My commission expires: 1/28/28

**SUZETTE M. SASS**  
Notary Public, State of Maine  
My Commission Expires Jan. 28, 2028

Dated: 09/21/23

Paul Thoen  
Paul Thoen

STATE OF: Colorado

County of: Jefferson

Date: 9/21/23

Personally appeared before me the above named Paul Thoen, who, being duly sworn, did testify that the foregoing testimony was true and correct to the best of his knowledge and belief.

Before me,

Kaysie Carlson  
Notary Public

My commission expires: 6/29/2027

**KAYSIE CARLSON  
NOTARY PUBLIC  
STATE OF COLORADO  
NOTARY ID 20234024695  
MY COMMISSION EXPIRES 06/29/2027**



# **EXHIBIT A**

---

### Areas of Expertise

- Technical Expertise – Water Treatment, Mineral Processing, and Process Improvement
- Business Development Specialist
- Team Building and Leadership
- Client Relationship Advancement
- Industry Expertise – Mining and Mineral Processing, Heavy Industry, SAGD Upstream Oil Production
- Business Management
- Strategic Planning and Implementation
- Contract Negotiation and Vendor Relations

---

### Skills Concentration

#### *Technical*

- Detailed knowledge of all aspects of water treatment including process water scale and corrosion control, effluent treatment, mine water, and wastewater systems including clarification, cyanide destruction, heavy metal removal, remediation, and utilities (boiler / cooling) pretreatment and functional treatment.
- Experienced in precious metals, base metals, iron ore, uranium, alumina, industrial minerals processing and coal preparation operations.
- Extensive experience in computer modeling including membrane and saturation simulations, mixed water simulations and treatment dosage prediction utilizing a variety of modelling software packages.
- Experienced in laboratory management, laboratory techniques and reporting of results, including reporting to government agencies.
- Extensive experience in laboratory testing including thickening, clarification, dewatering, filtration, dust suppression and all aspects of analytical chemistry related to water treatment.
- Detailed knowledge of gold milling including flotation, leaching, CIP, CIL, dewatering, carbon elution, electrowinning, carbon reactivation, gravity gold recovery, Meryl Crowe precipitation, autoclave/roaster operation, backfill/paste fill production, etc.
- Authored and delivered a wide variety of training courses including mineral processing technical training, influent water treatment, wastewater treatment, product line knowledge, health and safety, sales, account management, and time management.
- Developed and implemented sampling and monitoring programs including scale and deposit control, carbon fouling, carbon activity, strip circuit performance, effluent water quality, dust control efficiency, etc.
- Authored and presented technical papers at a variety of conferences including the National Canadian Mineral Processors Conference.
- Managed the mining industry product line and provided technical support.
- Introduced new product lines to meet industry needs including dust suppressants, emulsion flocculent, dewatering aids, rheology modifiers, corrosion inhibitors and antiscalants.
- Recognized global expert in water management, corrosion and scale inhibition in mineral processing and mining operations.

## *Business Development*

### **ChemTreat**

- Directed the activities of the Mining Strategic Accounts team which encompassed corporate sales activities, field sales support, all aspects of mining and mineral processing technical support, product line development, new vendor and raw materials sourcing and direct support to the ChemTreat corporate analytical services, product management and compliance teams.
- Direct involvement and team management to develop a mining business for ChemTreat in Canada. Grew annual mining sales from \$0 to over \$5MM.
- Direct involvement and team management to develop a mining business for ChemTreat in Mexico. Grew annual mining sales from \$0 to over \$5MM.
- Overall growth of annual ChemTreat North America mining business from less than \$5MM to over \$25MM during my tenure as Director of Mining.
- Oversaw as a team member the integration of a significant acquisition in South America resulting in an additional \$22MM in annual revenue in the mining space. Oversaw the integration of my team into the support structure for the LATAM mining team.
- Forged entry into the Turkish mining industry by directly closing a mining account with revenue of more than \$1.5MM per year. This allowed ChemTreat to pursue additional growth opportunities in Turkey without taking a financial loss on the business development costs.
- Provided direction and education to the Senior Management Team regarding mining and mineral processing water treatment opportunities, markets, go to market strategies, raw materials and product line needs, etc.
- Oversaw the introduction of dust control, powdered flocculent and freeze control product lines to the ChemTreat mining products portfolio.
- Identified an appropriate toll blender to support the Canadian mining business and facilitated the business relationship with this toll blender greatly improving ChemTreat's competitive position in the market.
- Implemented a variety of reporting, account auditing, best practices, communication systems and associated sales management tools for the corporate sales and field sales mining teams.

### **Tetra Tech**

- As Director of Business Development, EPCM and Strategic Accounts participated in the Mining and Minerals functional leadership team for North American operations.
- Introduced an expanded Strategic Account Management program to align with the formation of Tetra Tech's Global Mining Practice including standardization of the account planning process, training of account managers and team members, development of a global account management structure, etc.
- Developed and implemented an enhanced proposal system for major opportunities including EPCM (Engineering, Procurement and Construction Management) and Sustaining Capital Program Management opportunities resulting in improved win rate and significant reduction in proposal costs.
- Provided leadership for direct reports in the business development team in Canada and restructured to provide better coverage of the junior, mid-tier and senior mining markets while also enhancing business development support for regional offices.

- Provided direct sales input through my industry contact network securing opportunities and projects in all service lines (front end consulting, sustaining capital and EPCM).

### **Ashland Hercules Water Technologies**

- As Director of Business Development, Mining and Minerals with AHWT responsible for all aspects of business development required to facilitate AHWT creating a stand-alone mining specialty chemical business unit. leveraging existing success in water treatment specialty chemicals to become a fully integrated specialty chemical supplier for the mining vertical market.
- Educated the AHWT management team on the mining industry including market drivers, unmet industry needs, methods of dealing with sector cyclicalities, sales model, service model, etc.
- Provided input and review to all mining related presentations made to AHWT and Ashland senior management including presentations to the Board of Directors.
- Provided technical insight and direction to ensure alignment with unmet industry needs utilized to develop both the mining R&D/product development program and the external technology scouting program and continued to provide overall business development oversight to both of these programs.
- Created a global bottom-up market analysis of the specialty chemical market space within the mining vertical which was utilized for business planning for the venture. This analysis covered global consumption, revenue and profit pool for all mineral subsectors for water treatment products (deposit and corrosion control products, boiler and cooling water treatments, coagulants, flocculants, metal precipitants), process recovery aids (flotation reagents, flocculants, SX reagents, leaching aids), and throughput aids (grinding aids, viscosity and rheology modifiers) and adjacent products (dust suppressants, freeze modifiers, release agents).
- Developed five-year global growth plan for a stand-alone (venture) mining division which included resourcing (manpower) requirement projections, sales growth based on resourcing and the R&D pipeline, EBIT growth based on product line mix and manpower loadings, etc. This model was utilized by AHWT senior management to decide to implement the venture business model with a target of growing AHWT's mining business from the current \$60MM per year level to \$200MM per year in five years.
- Travelled extensively throughout North America, Latin America and Australia supporting direct sales opportunities, working with local mining technical sales personnel, and providing mining related training both in classroom settings and in the field.
- Provided direction and oversight to the North American strategic accounts group to allow inclusion of a mining industry component and developed a Mining Strategic Account program for the Australian business unit.
- Individually secured over \$3,000,000 in annual revenue through direct sales efforts based on my industry contacts and track record.

### **Wardrop Engineering**

- Implemented a strategic account management approach to business development activities for Vale, Xstrata Nickel and Goldcorp.
- Secured the EPCM contract for the Xstrata Acid Plant Dry Tower replacement through a strategic approach to the opportunity including negotiation of a partnership with Outotec for design technology. This was a major success based on poor prior performance by Wardrop on another large EPCM project with Xstrata Nickel.

- Secured the EP and construction support contract for the Goldcorp Cyanide Detox (SO<sub>2</sub>/Air plant) for the Porcupine Mine property through a strategic approach including submission of the EPCM proposal as an alternate to the engineering only bid as requested.

### **Ashland Water Technologies (Highlights)**

- Director, Strategic Accounts America's responsible for managing strategic account activities with a team of ten Strategic Account Managers. Responsible for over \$120 MM in annual sales and a growth target of over \$15 MM per year.
- Led implementation of the Strategic Account Management program for Ashland Water Technologies China operations.
- Team lead for Global Strategic Accounts process development during the Ashland Water Business Redesign process. Provided leadership and direction for a global team designing and implementing the future strategic account management program for the Ashland Water Technologies business unit formed through amalgamation of the former Drew Industrial, Drew Marine and Degussa business units.
- Strategic Account Executive Responsible for all aspects of business development and relationship management with major base metal and precious metals mining corporations on a global basis including strategic planning, marketing, proposal preparation and project conversion. Achieved double digit growth and secured multiple supply agreements including a sole source agreement for all Barrick North America water treatment which has stood for over 10 years through multiple renewals.
- As Regional Business Manager for Ashland Water Canada was responsible for all aspects of sales and business operations (S&D, strategic planning, hiring, training, goal setting and performance monitoring, etc.) for all mining related accounts as well as all operations in Western Canada.
- Introduced Ashland's mining industry specialty chemical product lines in Canada and grew the business from zero to a team of 10 field sales and support personnel with annual sales exceeding \$6,000,000 and gross profit exceeding \$3,500,000 per year.
- Managed Professional Engineers, technologist and technicians across a large geographic area while delivering results that consistently exceeded sales and profit margin targets. Comfortable interacting at all levels within organizations from the plant floor to the boardroom.

### **Management and Leadership**

- Accomplished leader with the ability to articulate vision, motivate others and lead by example.
- Experienced in cost management and profit optimization in a complex profit and cost center environment including operation of warehousing and distribution, toll manufacturing, inventory control systems, expense control, product cost management and overall EBIT responsibility.
- Experienced in mentoring, objective setting, performance evaluation, and employee development planning, as well as other management techniques.
- Experienced in development and management of M&A pipeline including working with merchant bankers in the M&A atmosphere.
- Led and participated in multiple major business designs including global market analysis, resource/manpower requirement projections, R&D pipeline development, revenue and profit projections, etc.; Created the blueprints for Ashland's global mining specialty chemical business unit.



- Successfully developed and participated in synergy opportunities across internal diverse business units including joint work with Ashland's Distribution Services, Industrial Chemical and Solvent and Foundry divisions.
- Member of the Global Strategic Sales leadership team for Ashland consisting of Directors from Americas, Europe/Middle East/Africa, Asia-Pacific and the Global Strategic Contracts Manager as well as Vice President, Global Strategic Sales.
- Implemented and streamlined the Global Strategic Sales (Corporate Accounts) organization as developed through the Ashland Water Business redesign process and integrated business development across three formerly separate business units.
- Maintained an excellent safety record and implemented the first safety training system for field technical and service personnel in Ashland's Water Management Division.

---

## Employment History

<i>Principle</i> Mine Water Service Inc.	<i>2021 to Present</i>
<i>Director, Mining and Mineral Processing</i> ChemTreat	<i>2014 to 2021</i> Global
<i>Director, EPCM and Strategic Accounts Business Development</i> <i>General Manager, Sudbury Operations</i> Tetra Tech WEI, Mining and Minerals Division	<i>2012 to 2014</i> North America
<i>Director, EPCM and Strategic Accounts Business Development</i> Tetra Tech WEI, Mining and Minerals Division	<i>2011 to 2014</i> North America
<i>Director, Global Business Development - Mining and Minerals</i> Ashland Hercules Water Technologies	<i>2009 to 2011</i> Global
<i>Business Development Manager – Mining Majors</i> Wardrop Engineering, Mining and Minerals Division	<i>2008 to 2009</i> Canada
<i>Director – Global Strategic Sales, Americas</i> Ashland Water Technologies	<i>2007-2008</i> Americas
▪ Member of the Americas Leadership Team consisting of the Vice President, Americas and seven Regional Business Leaders responsible for business operations across North and South America.	
<i>Senior Account Executive – Corporate Strategic Accounts</i> Ashland Inc., Drew Industrial	<i>2005-2007</i> North America
▪ Recipient of the Ashland Circle of Champions award for outstanding account executive	
<i>Regional Business Manager</i> Ashland Canada, Drew Division	<i>1998-2004</i> Canada
▪ Two-time Recipient of the Canadian Employee of the Year	

# *Brian Danyliw, BSc.*

705-618-6729

- Recipient of the Ashland Circle of Champions award for outstanding contribution to sales growth

## *Mining Business Manager*

1987-1998

Ashland Canada, Drew Division

Eastern Canada

- Recipient of the Canadian Employee of the Year
- Recipient of the Ashland Circle of Champions award for outstanding contribution to sales growth

## *Area Manager*

1982-1987

Calgon Canada, Water Management Division

Ontario

- Awarded patent for Improved Process of Uranium Liquor Clarification

---

## Education

### *Bachelor of Science*

*Chemistry and Physics*

Laurentian University

- Graduated Cum Laude
- Awarded LAMPS Academic Achievement Award for Science and Engineering

### *Chemical Engineering Technology*

*Environmental*

Cambrian College of Applied Arts and Technology

---

## Interests and Industry Associations

- Gardening, cooking, hiking, travel, boating and off grid living.
- Chair of Northeastern CMP (Canadian Mineral Processors division of CIM) 2013 – 2017
- Chair Central Ontario CMP 2014 – 2017.
- Member of National CMP executive 2017 – 2019.
- Developed and delivered a short course “Water Treatment for Mineral Processors” at the 2015 National CMP conference.
- Delivered short course at Central Ontario CMP in 2017.

## **EXHIBIT B**

### **BACKGROUND**

Well rounded team leader and manager of engineers, scientists, technicians, and mechanics to design, build and fabricate membrane-based water and wastewater treatment systems. Extensive experience scaling up, commercializing, designing, and installing cutting edge water treatment technology. Proficient and comfortable in technical sales environments. Excellent communication skills for cultivating and building long term client relationships with diverse, international client base. Areas of expertise include: Industrial Water Treatment Systems, Membranes, Mining, Filters, Water Chemistry, Process Engineering, Materials Engineering, Analytical Chemistry, and Chemical Engineering.

---

---

### **PROFESSIONAL EXPERIENCE**

#### **Chief Technology Officer, Separation Engineering - Division of Shelton Associates, Lancaster, PA 2020 - Present**

Oversee all technical aspects of water and wastewater treatment plants for the mining, energy, and food and beverage sectors. Provide supervisory project management for large-scale industrial water and wastewater treatment systems. Develop and implement new water treatment technologies to maintain technical superiority over competitors. Create PFDs and PIDs for commercial-scale water treatment systems. Design, build and operate bench and pilot-scale treatment units to demonstrate technical and economic feasibility of proposed commercial industrial water treatment systems. Develop budgets and schedules for commercial scale treatment systems. Write proposals, reports, and contracts and present to potential clients. Serve as primary technical point of contact for diverse, international client base. Interface directly with customers and provide technical and support services.

#### **Director of Water Technology, Newmont Mining, Englewood, CO, 2017 - 2020**

Responsible for water treatment and management for all of Newmont's global operating sites. Ensure every site is meeting all environmental discharge standards. Develop and approve water treatment systems for all operating sites. Develop and implement new water treatment technologies to maintain technical superiority over competitors. Create PFDs and PIDs for commercial-scale water treatment systems. Design, build and operate bench and pilot-scale treatment units to demonstrate technical and economic feasibility of proposed commercial sized water treatment systems.

#### **Chief Technology Officer, Industrial Water Management, Lakewood, CO, 2010 - 2017**

Lead multidisciplinary team to design, fabricate, install and commission water and wastewater treatment systems based on membrane technology. Develop and implement new water treatment technologies to maintain technical superiority over competitors. Create PFDs and PIDs for commercial-scale water treatment systems. Design, build and operate bench and pilot-scale treatment units to demonstrate technical and economic feasibility of proposed commercial industrial water treatment systems.

#### **Director, Fuel Cell and Membrane Division, ITN Energy Systems, Inc., Littleton, CO, 2010 - 2013**

Managed daily operations of Fuel Cell and Membrane Division. Supervised a team of scientists, engineers and technicians to develop and commercialize cutting edge fuel cell, membrane and battery technologies. Wrote proposals to secure private and public investment to fund development and commercialization activities. Directly responsible for securing over \$5MM in private and government funding for fuel cell and battery research and development. Interface directly with clients to develop and grow long term business relationships. Direct report to CEO and responsible for profit and loss of Fuel Cell and Membrane Division

**Chief Technology Officer and Vice President of Process Engineering, HW Process Technologies, Lakewood, CO, 2007 - 2010**

Directed a staff of project managers, scientists, engineers, and technicians to design, engineer and fabricate large-scale wastewater treatment systems. Lead design of membrane-based industrial water treatment systems for a variety of mineral processing and produced water applications. Designed, built and operated bench and pilot-scale treatment units to demonstrate technical and economic feasibility of treatment systems. Created PFDs and PIDs for commercial-scale water treatment systems. Developed and implemented new water treatment technologies to maintain technical superiority over competitors. Provided overall project supervision for up to 5 concurrent field projects worldwide. Authored proposals and reports, and interfaced directly with a diverse, international client base. Wrote invention disclosures and patent applications for newly conceived inventions and ideas.

**Research Professor, Colorado School of Mines, Chem. Engineering Dept., Golden, CO, 2005 – 2007**

Conducted research on membrane-based separation and purification processes for liquid and gas applications. Investigated new applications for inorganic, organic and metallic membranes for hydrogen separation. Developed new materials and processing techniques to fabricate novel membranes. Authored technical progress reports, funding proposals and research articles. Served as mentor and advisor to graduate students.

**Operations Manager, ITN Energy Systems, Littleton, CO, 2000 - 2005**

Supervised a team of scientists, engineers and technicians in the development and commercialization of fuel cell and membrane technologies. Wrote funding proposals and progress reports. Supervised facilities maintenance, including installation, calibration, and repair of all laboratory equipment.

**Senior Engineer, BASX Systems, Fort Collins, CO, 1997 - 2000**

Designed, built, installed, and operated membrane-based water treatment systems for industrial wastewater. Performed lab scale and pilot scale testing to demonstrate feasibility of commercial systems. Led all facets of new product development, application engineering, and new technology evaluation. Developed PIDs and PFDs based on data from pilot scale testing. Provided field service and support.

**Chemical Engineer, Coors Ceramics, Golden, CO, 1994 - 1997**

Key contributor in development and commercialization of ceramic membrane technology for a variety of gas and liquid applications. Designed and built analytical test equipment to monitor quality control of ceramic membrane production. Provided field service and application engineering for gas and liquid filtration systems. Helped coordinate 3 CRADA's aimed at commercializing ceramic membrane technology.

**Post Doctoral Fellow, Colorado School of Mines, Chemical Eng. Dept., Golden, CO 1993 - 1994**

Investigated fundamental transport mechanisms of gases through a variety of organic, inorganic and metallic membranes. Contributed to several research projects to develop and optimize new separation technologies for gas and liquid applications.

---

---

## **EDUCATION**

**Ph. D., Analytical Chemistry, University of Colorado, Boulder, CO, 1993.**

**B.A., Chemistry, University of Minnesota, Morris, MN, 1989**



# **EXHIBIT C**



## **Wolfden Resources, Pickett Mountain Project, Mine Water Treatment Scoping Study**

### **Introduction**

Mine Water Service Inc. (MWS) was retained by Wolfden Resources to identify and examine various options to provide a water treatment process to allow treatment on surface contact water and underground mine produced water. This treatment process is required to provide effluent water of a quality that meets or exceeds identified existing water quality at the Pickett Mountain Site.

Mine Water Service is a consultancy operated by Brian Danyliw, a mining industry water treatment professional with over 40 years of experience. In addition to a thorough understanding of all aspects of water treatment relating to mining operations, Brian also has extensive process knowledge of underground mining as well as mineral processing of ore bodies similar to Pickett Mountain. In addition to Brian, the team assembled for this project included Kevin Gotschalk, Principle with Oracle Water Services, a water treatment expert with over 40 years of water treatment experience and Dr. Paul Thoen, Chief Technology Officer with Shelton Associates, a company with extensive experience in designing, installing and operating membrane treatment facilities at mining operations throughout the world.

The scope of experience of MWS includes site and technical support on water treatment issues at over 80 mining operations around the world.

### **Project Report Objectives**

The overall objective of this report is to provide a comprehensive and detailed plan for water treatment at the Pickett Mountain site that meets the requirements of the Land Use Planning Commission (LUPC) that treated water will meet existing site water quality. Existing site water quality is based on a set of ten (10) samples collected September 23, 2021 and analyzed by Maine Environmental Laboratory<sup>1</sup>. Detailed analysis reports from these ten samples can be found in Appendix 1 of this report. Water volumes and flow rates are based on the technical memorandum “Proposed Pickett Mountain Mine Project Precipitation Runoff Collection Areas - Mine Only Option” dated May 23, 2022 and revised August 25, 2022, prepared by Wood PLC Engineering consultants.”<sup>2</sup> discussed in detail within this report.

Included in the report is information and background on the water treatment technologies proposed to demonstrate the ability of these technologies to produce the required quality of treated water. This report details the types of treatment that will be employed, the plant process, basis of plant sizing, mass and water

---

<sup>1</sup> Maine Environmental Laboratory, One Main Street, Yarmouth, ME 04096  
Report Information: Batch ID: ONE 10624, Report ID: 10624-211027-1313, Date of Issue: October 27, 2021

<sup>2</sup> Peters, M. (2022, May 23, Revised August 25). TECHNICAL MEMORANDUM, Proposed Pickett Mountain Mine Project Precipitation Runoff Collection Areas - Mine Only Option



balances, treatment efficacy based on computer modeling as well as relevant experience of the authors. The anticipated final treated water quality was developed utilizing input water quality data from a relevant operating mine example (Half Mile Mine- owned by Trevali Mining Corporation located West of Miramichi, New Brunswick, Canada.).

## **Design Criteria**

Daily Identified Water Treatment Requirement:	152.1 USGPM <sup>3</sup>
Flow Contingency:	30%
Design Permeate (final treated effluent) Rate:	200 USGPM
Design Plant Influent Rate:	205 USGPM
Duty:	Continuous, 24 hrs/7/365
Input Water Quality:	Provided by Wolfden – Appendix 1
Background (target) Water Quality:	Provided by Wolfden – Appendix 1

## **Treatment Approach**

The approach to water treatment for the Wolfden Resources, Pickett Mountain Project (Project) is to employ best available technologies to ensure effluent water meets Maine Chapter 200<sup>4</sup> and Title 38, Chapter 3 wastewater discharge requirements<sup>5</sup>. Proposed water treatment technologies for this Project are multistage and scalable. First, membrane filtration utilizing ultrafiltration (UF), which removes particles down to 0.1 micron in size, is a pretreatment stage to remove suspended solids. Second, reverse osmosis (RO) membranes which remove constituents down to atomic radii in size. Through this combination of proven membrane filtration techniques, water quality to meet regulatory requirements can be achieved. RO can effectively remove all contaminants from water, except for some dissolved gases (such as carbon dioxide and oxygen, which are nonhazardous normal constituents of water) and can produce pure water containing only water molecules.

Membrane filtration technologies date back to the late 1950's and were initially developed to allow for the generation of potable water from sea water. Over the years, continued development and refinement of the technology and extensive adoption of the technology across multiple industries and applications has resulted in improved efficacy and reduced costs. In the past decade, membrane filtration water treatment, and in particular some combination of microfiltration (MF), UF, nanofiltration (NF) and RO, has become the industry standard for water and wastewater treatment across multiple industries, including mining and mineral processing. The US Food and Drug Administration (USFDA) guidelines state that "An RO water purification system with several modules connected in series can produce water containing less than 0.1 ppm Total

---

<sup>3</sup> Permeate flow

<sup>4</sup> 06-096 CMR 200

<sup>5</sup> Title 38, Chapter 3: Protection and improvement of Waters. (n.d.). Retrieved July 21, 2022, from <https://www.mainelegislature.org/legis/statutes/38/title38ch3sec0.html>



Dissolved Solids (TDS;(resistivity about 1 megohm-cm).”<sup>6</sup> This level of purity is essentially pure water, containing only water molecules, without any elements, metals, or contaminants present. Many examples of utilization of membrane filtration systems to treat mining and mineral processing influenced waters throughout the world are available. As per the US Environmental Protection Agency (USEPA) Reference Guide for Treatment Technologies for Mine-Influenced Water “[RO] Can remove 90 to 98 percent of TDS. A TDS removal efficiency of 98.5 percent was observed during pilot testing of the membranes tested.”<sup>7</sup>

The approach taken for the Pickett Mountain Project is to design a water treatment system which will accomplish the following,

1. Treatment of surface contact water and underground produced water with the ability to produce effluent which meets or exceeds site-specific existing water chemistry (quality).
2. Treatment plant design to accommodate peak flow expectation with additional contingency flow capacity.
3. Minimization of treatment plant concentrate wastewater flow.

## **How Membrane Water Treatment Works**

### **Ultrafiltration**

The first step employed in the Pickett Mountain water treatment process is ultrafiltration (UF). It is designed to remove particles down to approximately 0.1 micron in size. Membranes manufactured for UF can be polymeric or ceramic and we will employ ceramic UF membranes because of their robust nature and ability to treat a wide range of influent characteristics. Ceramic UF membranes are essentially hollow tubes constructed of sintered metal (such as aluminum oxide) which results in a porous structure (Figure 1). This porous structure allows the ceramic tubes to act as filters while the sintered metal construction provides abrasion resistance, the ability to withstand a wide range of operating conditions (such as temperature extremes), and long life.

Influent water is forced under pressure through the hollow ceramic tubes. Filtrate (clean water) then passes through the pore structure of the tube walls and exits the membrane system.

---

<sup>6</sup> <https://www.fda.gov/inspections-compliance-enforcement-and-criminal-investigations/inspection-technical-guides/reverse-osmosis>

<sup>7</sup> U.S. Environmental Protection Agency, Office of Superfund Remediation and Technology Innovation, REFERENCE GUIDE to Treatment Technologies for Mining-Influenced Water, March 2014 EPA 542-R-14-001



Figure 1. Ceramic UF Membrane  
Image Credit | Wikiwayman [CC BY-SA]

## Reverse Osmosis Overview

Reverse osmosis (RO) represents state-of-the-art technology in water treatment. RO was developed in the late 1950's as a method of desalinating sea water. Today, RO has earned its name as the most convenient and thorough method to filter water. It is used by most water bottling plants, and by many industries that require ultra-refined water in manufacturing, such as microelectronics and pharmaceuticals, as well as high quality water to meet strict environmental discharge requirements. This advanced technology is also available for hiking enthusiasts and to homes and offices for drinking water filtration.

The RO system is dependent upon, and built around, individual membranes. Each membrane consists of a spiral wound sheet of semi-permeable material. Multiple layers of membrane and supporting material (outer wrap, spacers and permeate collection material) are formed into a tube surrounding a perforated central tube (Figure 2). Multiple layers of membrane allow the system to overcome the relatively low flow per unit area through the semi-permeable RO membranes. Feed water enters one end of the RO tube and as it passes down the length of the tube pure water passes through the RO membranes and reaches the perforated central tube. Water containing contaminants (as contaminants don't pass through the membranes) continues along the length of the tube and exists as concentrate (wastewater). Pure water that passes through the membranes is collected in the central perforated tube and exists the system as permeate.



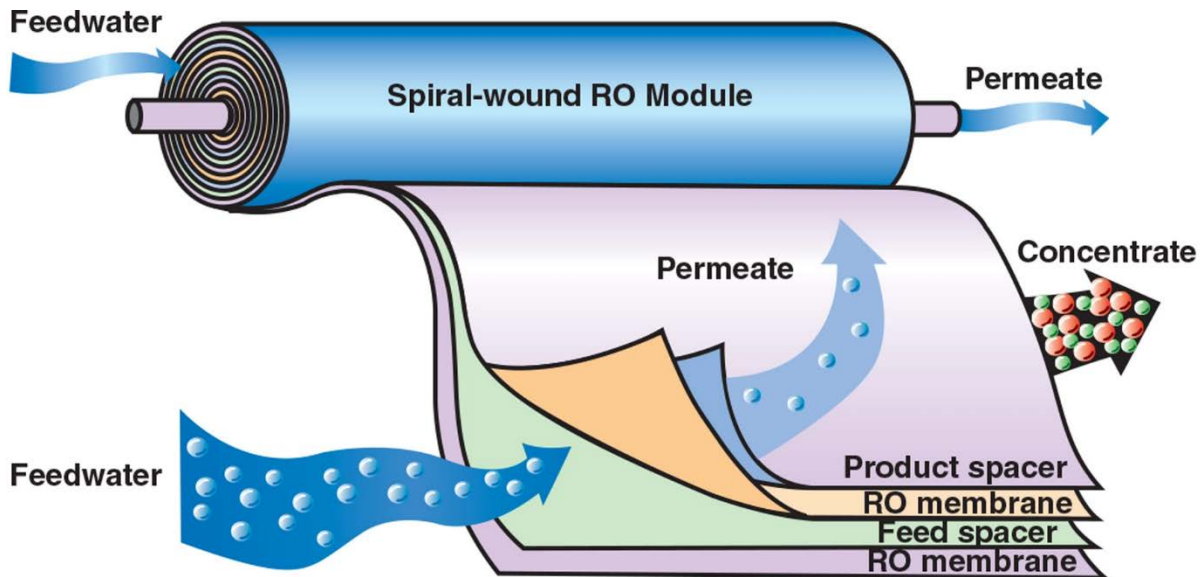

*Source: Ionics Inc.*

*NF—nanofiltration, RO—reverse osmosis*

*Density of dots: highest density—concentrate, medium density—feedwater, lowest density—permeate*

Figure 2. Spiral Wound RO Membrane

### How RO Works

To understand "reverse osmosis," it is best to start with an understanding of normal osmosis. According to Merriam-Webster's Collegiate Dictionary, osmosis can be explained as the "movement of a water through a semipermeable membrane (as of a living cell) into a solution of higher solute concentration that tends to equalize the concentrations of solute on the two sides of the membrane". A semipermeable membrane is a membrane that will pass some atoms or molecules but not others. Saran™ wrap is a membrane, but it is impermeable to almost everything. An interesting example of a semipermeable membrane is the eggshell. Egg shells have pores large enough to allow oxygen and water vapor through, but small enough to prevent bacteria and dust from entering.

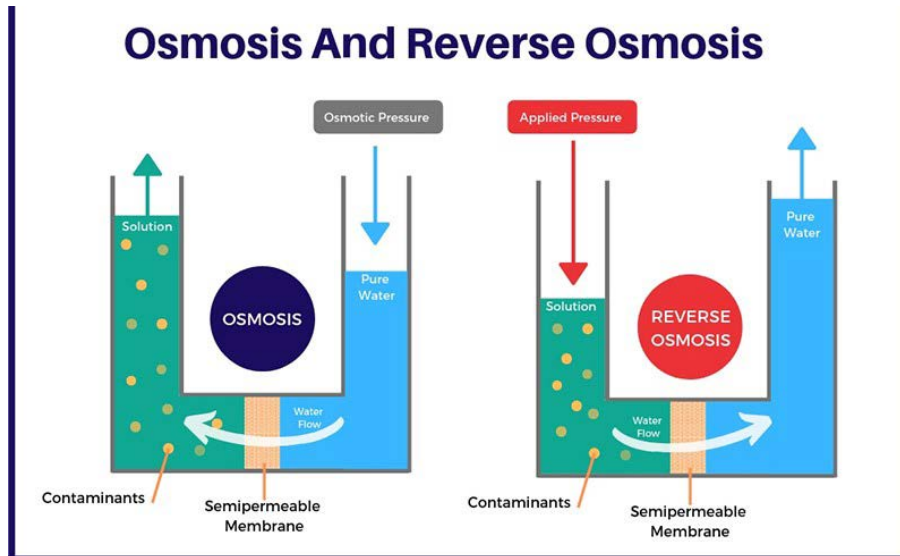

Figure 3, Osmosis and Reverse Osmosis<sup>8</sup>

In Figure 3 above, in the case of osmosis, the membrane allows passage of water molecules but not impurities such as organic molecules, salts or heavy metals. One way to understand osmotic pressure would be to think of the water molecules on both sides of the membrane. They are in constant motion. On the raw water side, some of the pores get plugged with contaminants, but on the pure-water side that does not happen. Therefore, more water passes from the pure-water side to the contaminated water side, as there are more pores on the pure-water side for the water molecules to pass through. The water on the contaminated side rises until one of two things occurs:

- The contaminant concentration becomes the same on both sides of the membrane (which isn't going to happen in this case since there is pure water on one side and contaminated water on the other).
- The water pressure rises as the height of the column of contaminated water rises, until it is equal to the osmotic pressure. At that point, osmosis will stop.

Osmosis is why drinking salty water (like ocean water) will kill you. When you put salty water in your stomach, osmotic pressure begins drawing water out of your body to try to dilute the salt in your stomach. Eventually, you dehydrate and die.

<sup>8</sup> Membracon. (2019, November 26). *Reverse osmosis systems in industrial processes*. Smart Water Magazine. Retrieved August 16, 2022, from <https://smartwatermagazine.com/news/membracon/reverse-osmosis-systems-industrial-processes>

In RO, the idea is to use the membrane to act like an extremely fine filter to create pure water from salty or contaminated water. The contaminated water is put on one side of the membrane and pressure is applied to stop, and then reverse, the osmotic process. It is fairly slow, but it works effectively for water purification (Figure 4).

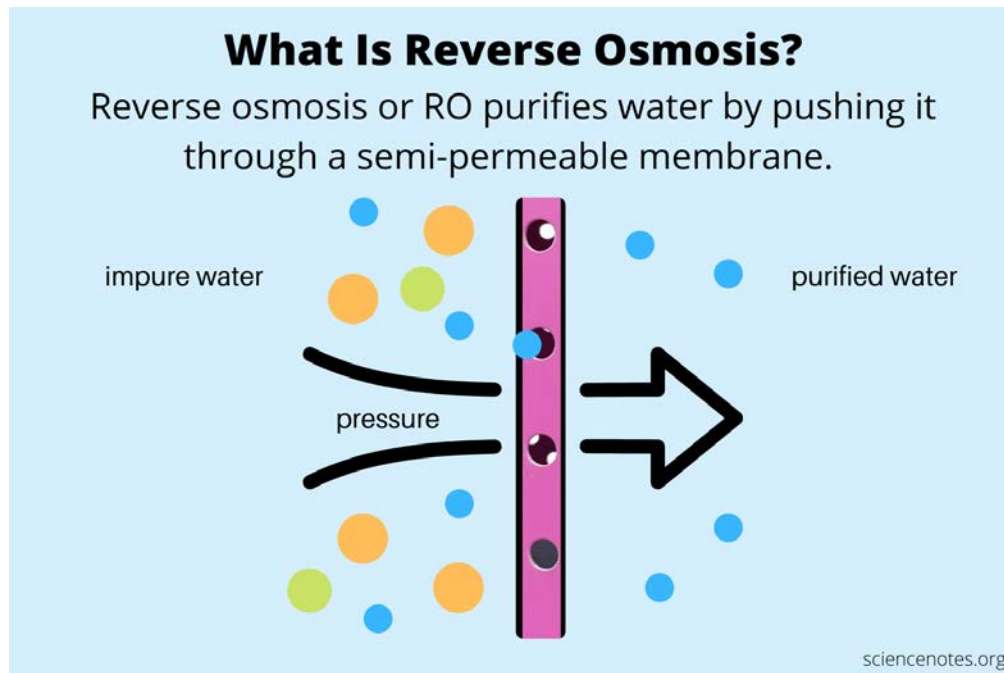

Figure 4. Reverse Osmosis<sup>9</sup>

### Contaminant Removal

Reverse osmosis is an extremely effective technology in removing contaminants from water. The following chart (Figure 5) outlines some of RO's capabilities regarding specific contaminants compared to other filtration methods.

---

<sup>9</sup> Helmenstine, A. (2022, February 21). *What is reverse osmosis?* Science Notes and Projects. Retrieved August 16, 2022, from <https://sciennotes.org/what-is-reverse-osmosis/>

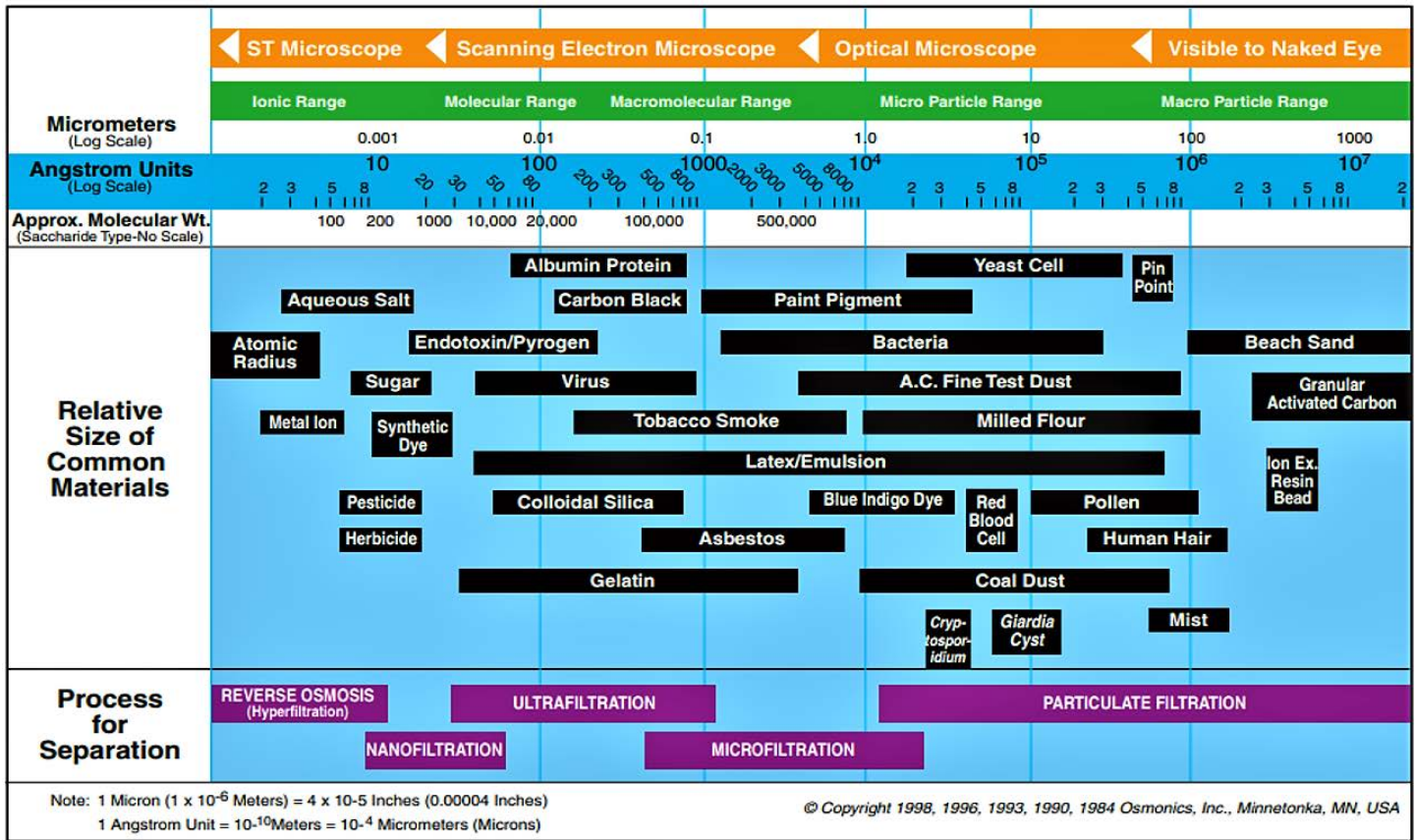

Figure 5, Membrane Filtration Removal Sizes<sup>10</sup>

In the case of heavy metal and other contaminant removal from wastewater, RO can separate all contaminants except for some dissolved gases such as oxygen and carbon dioxide (it should be noted that dissolved gasses are naturally present in all water and are not hazardous). The typical separation efficacy of common ions is listed in the Table 6 below. These rejection efficiencies have been established through a vast number of actual RO system operations and specific documentation for various rejection efficiencies can be found through review of a variety of technical publications. It should be noted that these separation efficiencies are for a single pass through a typical RO membrane of the same type chosen for the Pickett Mountain water treatment plant. Sequential treatment, through a second RO membrane, will result in an additional separation efficacy equal to that listed below. This means, as an example, aluminum separation through two passes would result in 96% - 98% removal in the first pass and an additional 96% - 98% removal of any residual in the second pass for a total removal efficacy of 99.8% - 99.96%. A third pass would therefore result in 99.992% - 99.999% removal.

<sup>10</sup> WP-Content. (2004, August 15). Home. WCP Online. Retrieved July 21, 2022, from <https://wcponline.com/wp-content/uploads/2004/08/Figure-1-3.png>

Ion	% Rejection*	Ion	% Rejection*
Calcium	93-99	Bromide	90-95
Sodium	92-98	Phosphate	95-98
Magnesium	93-98	Cyanide	90-97
Potassium	92-96	Sulfate	96-99
Manganese	96-98	Thiosulfate	96-98
Iron	96-98	Silicate	92-95
Aluminum	96-98	Silica	90-98
Copper	96-99	Nitrate	90-95
Nickel	96-99	Boron	50-70
Cadmium	93-97	Borate	30-50
Silver	93-96	Fluoride	92-95
Zinc	96-98	Polyphosphate	96-98
Mercury	94-97	Orthophosphate	96-98
Hardness Ca&Mg	93-97	Chromate	85-95
Radioactivity	93-97	Bacteria	99+
Chloride	92-98	Lead	95-98
Ammonium	80-90	Arsenic	50-90

Figure 6. Typical Rejection Rates for Thin Film Composite RO Membranes

\*Nominal rejection characteristics of thin film composite reverse osmosis membranes. Membrane Rejection Levels. (n.d.). Retrieved July 21, 2022, from [https://www.watertreatmentguide.com/Membrane\\_Rejection.htm#Thin%20Film%20Composite](https://www.watertreatmentguide.com/Membrane_Rejection.htm#Thin%20Film%20Composite)

## **Membrane Water Treatment in Mining**

Multiple examples of utilization of UF and RO to treat mining influenced waters are available throughout North America and worldwide. These mining operations include examples of treatment of site contact water, underground mine water effluent and tailings facility (TMF) decant water, from both mine only and mine/mill operations, for direct discharge to the environment.

## **Input and Target Water Volume and Quality**

While no actual produced water from the Pickett Mountain operations is available for analysis, the choice of UF and RO for the water treatment plant will allow successful removal of any metals or other contaminants present once further analysis is conducted as part of the Chapter 200 process and the mine is in operation. For the purposes of this study and to facilitate process design and computer modeling, input water quality is based on water chemistry data supplied by Half Mile Mine. Input water is based on the highest value (worst case) from Half Mile Mine samples which were collected throughout the lifecycle of the mine from construction through operation and maintenance. Sampling at Half Mile was completed by the mine site environmental team and samples were collected using lab provided sampling guidelines and analysis





performed by RPC Science and Engineering (Research and Productivity Council). RPC is a certified laboratory based in Fredericton, New Brunswick. Sampling and analysis took place from 2011 through 2019.

While variations in water quality are expected due to variations in site-specific mineral deposits, based on the MWS's experience with multiple polymetallic massive sulfide mining operations, the Half Mile Mine water quality data is similar to other mine only operations and provides an appropriate comparison to water quality data expected from Pickett Mountain.

Produced contact water volumes are based on peak monthly volumes as described in the technical memorandum "Proposed Pickett Mountain Mine Project Precipitation Runoff Collection Areas - Mine Only Option"<sup>11</sup> dated May 23, 2022 and revised August 25, 2022, prepared by Wood PLC Engineering consultants.

Target effluent quality is based on water sampling results from the Pickett Mountain Site collected during groundwater sampling efforts in September 2021 and is the current data set available to evaluate background conditions (Table 1). The average target effluent water quality used in this report is the average of the target analytes from the 10 samples and includes the method detection limit (MDL) value for any samples reported by the lab as non-detect. The highest single value effluent water quality is the highest detected value and does not include the MDL for non-detects. Water analysis data is included in Appendix 1.

---

<sup>11</sup> Peters, M. (2022, May 23, Revised August 25). TECHNICAL MEMORANDUM, Proposed Pickett Mountain Mine Project Precipitation Runoff Collection Areas - Mine Only Option



Table 1. Input and Target Effluent Water Quality

Analyte	Units	Method Detection Limit	Target Effluent Quality Average MG/L	Target Effluent Quality Highest Single Analysis Result MG/L	Influent Water Quality (Highest Half Mile Value) MG/L
TOTAL ALKALINITY	MG/L as CaCO <sub>3</sub>	0.7	6.92	9.2	Not Reported
PHENOLPHTHALEIN ALKALINITY	MG/L as CaCO <sub>3</sub>	0.7	0.7	Not Detectable	Not Reported
BICARBONATE ALKALINITY	MG/L	1.3	Not Reported	Not Reported	Not Reported
CARBONATE ALKALINITY	MG/L	1.3	Not Reported	Not Reported	Not Reported
TOTAL PHOSPHORUS	MG/L	0.01	0.020	0.04	0.04
TDS	MG/L	10	38.5	51	Not Reported
TSS	MG/L	2.5	4.5	9.7	12
MERCURY	MG/L	0.0002	0.0002	Not Detectable	Not Reported
ALUMINUM	MG/L	0.005	0.1767	0.28	0.358
ANTIMONY	MG/L	0.0002	0.00045	0.0014	0.0009
ARSENIC	MG/L	0.0002	0.00042	0.0009	0.005
BARIUM	MG/L	0.003	0.0062	0.009	0.021
BERYLLIUM	MG/L	0.0002	0.0002	Not Detectable	Not Detectable
BORON	MG/L	0.02	0.02	0.02	0.196
CADMIUM	MG/L	0.00002	0.000132	0.00014	0.0477
CALCIUM	MG/L	0.1	2.81	3.6	91.8
CHROMIUM	MG/L	0.002	0.002	Not Detectable	Not Detectable
COBALT	MG/L	0.0003	0.0003	0.0003	0.151
COPPER	MG/L	0.0001	0.00116	0.01	0.383
IRON	MG/L	0.02	0.232	0.56	6.02
LEAD	MG/L	0.0001	0.00018	0.0005	0.0257
LITHIUM	MG/L	0.0001	0.00029	0.0005	0.0037
MAGNESIUM	MG/L	0.1	0.67	0.9	7.17
MANGANESE	MG/L	0.002	0.0334	0.075	1.27
MOLYBDENUM	MG/L	0.005	0.005	Not Detectable	Not Detectable
NICKEL	MG/L	0.002	0.002	Not Detectable	0.013
POTASSIUM	MG/L	0.1	0.28	0.4	5.92
RUBIDIUM	MG/L	0.0005	0.0005	Not Reported	0.0149
SELENIUM	MG/L	0.00006	0.00006	Not Reported	0.002
SILICON	MG/L	0.02	1.93	3	2.6
SILVER	MG/L	0.0003	0.0003	Not Detectable	Not Detectable
SODIUM	MG/L	0.1	0.99	1.2	25
STRONTIUM	MG/L	0.0003	Not Reported	Not Reported	0.25
SULFUR	MG/L	1	1.05	1.4	3
THALLIUM	MG/L	0.0001	0.0002	0.0008	Not Detectable
ZINC	MG/L	0.0002	0.00768	0.045	10
CHLORIDE	MG/L	0.3	0.512	0.62	Not Reported
FLUORIDE	MG/L	0.03	0.03	Not Detectable	Not Reported
NITRATE AS N	MG/L	0.1	0.1	Not Detectable	Not Reported
NITRITE AS N	MG/L	0.03	0.03	Not Detectable	Not Reported
PH	STU	0.01	6.712	6.30 - 7.04 (Range)	7.5
SPECIFIC CONDUCTANCE	µS/CM	25	26.6	28	732
SULFATE	MG/L	0.6	1.9	2.7	Not Reported
TOC	MG/L	0.7	10.06	12	Not Reported
DOC	MG/L	0.7	9.49	12	Not Reported
TOTAL CYANIDE	MG/L	0.005	0.0136	0.015	Not Reported
TURBIDITY	NTU	0.1	3.91	9.7	21.2
TRUE COLOR		5	48	70	Not Reported

Note: Units are milligram per liter (MG/L)

Target effluent quality average utilizes the MDL for all values that were reported by the laboratory as zero.



It should also be noted that oil, grease and other potential organic materials which might enter the wastewater stream through mining operations are considered in the treatment plant design. Modern underground mine design and operations carefully monitors and controls any discharge of oil and grease from underground mobile equipment. In addition to oil and grease separation systems used to separate and recover oil and grease from wash water, mobile equipment contain multiple failsafe devices designed to minimize the risk of any spills occurring due to equipment failures. Even with these safeguards in place, there remains potential for trace amounts of oil and grease to be in the mine effluent water sent to the water treatment plant. The inclusion of ceramic UF as a first treatment stage in the treatment plant design provides proven technology for rejection of oil and grease to the waste stream. This means that any trace amounts of oil and grease that may enter the water treatment plant will ultimately be retained within the mine wastewater system for disposal via cement preparation for backfill. As an example, one study conducted using ceramic UF membranes on oily wastewater documented a 97.6% rejection rate.<sup>12</sup>

## **Modeling Studies**

Modeling of UF RO systems was completed utilizing four different commercially available software packages. The accuracy of computer simulations versus laboratory and pilot studies was examined by the Texas Water Development Board and presented in their “Report 1148321310 Part II. Performance Evaluation of Reverse Osmosis Membrane Computer Models” which was published in 2014. In part their conclusions state, “In summary, the overall accuracy and precision demonstrated by the computer models evaluated as part of this study were within a reasonable level of expectation considering the limited amount of the start-up data available. The level of accuracy for first stage feed pressures was sufficient to facilitate a conservative selection of a first stage feed pump. The level of accuracy for rejection of most ion constituents and total dissolved solids was within the expected range considering the limited amount of start-up feed and permeate water quality data. Computer model accuracy was comparable to the accuracy provided by the results of a pilot study for the one full-scale facility for which pilot test data was available. Another pilot study evaluation demonstrated the similarity of performance provided by pilot testing and computer models in predicting the performance of a full-scale reverse osmosis membrane system. Computer models created to predict the performance of two different membranes used during single-element pilot tests demonstrated a sufficient degree of accuracy to validate the use of computer models in predicting the performance of a full-scale membrane system. The precision demonstrated by the computer models was, in most cases, sufficient to facilitate the design of a membrane system to accommodate similar membranes from multiple membrane manufacturers.”<sup>13</sup>

A number of commercial modeling programs are available, and each program utilize membranes that are commercially available from a single membrane manufacturer. The following programs were utilized to develop this water treatment plan.

---

<sup>12</sup> Chen, J.; Lv, Q.; Meng, Q.; Liu, X.; Xiao, X.; Li, X.; Liu, Y.; Zhang, X.; Gao, P. Study on Treatment of Low Concentration Oily Wastewater Using Alumina Ceramic Membranes. *Crystals* 2022, 12, 127. <https://doi.org/10.3390/cryst12020127>

<sup>13</sup> [https://www.twdb.texas.gov/publications/reports/contracted\\_reports/doc/1148321310\\_Part%20II\\_Performance%20Evaluation.pdf](https://www.twdb.texas.gov/publications/reports/contracted_reports/doc/1148321310_Part%20II_Performance%20Evaluation.pdf)



1. Hyr-RO-Dose from French Creek Software Inc., which is a specialized water treatment modeling program. The hyd-RO-Dose program is primarily designed to predict antiscalant requirements for membrane systems; however, to accomplish this, a detailed model of the membrane system input and output water chemistry is developed by the software. The primary benefit of the hyd-RO-Dose program is modeling of water chemistry parameters to five decimal places making it especially effective for ultra-pure water.
2. Wave software from Dupont. Wave is a modeling program developed by Dupont to support system designers utilizing various Dupont technologies, including UF and RO membranes from Dupont.
3. Winflows from Suez Water Technologies and Solutions. Winflows is a modeling program developed by Suez to support system designers utilizing various Suez technologies, including UF and RO membranes from Suez.
4. IMSDesign from Nitto Hydranautics. IMS Design is a modeling program developed by Nitto/Hydranautics to support system designers utilizing various Nitto/Hydranautics UF and RO membranes.

In all modeling cases, a single UF stage was utilized followed by a two-stage RO system to provide optimal metal and mineral removal. All programs were utilized as a check against each other and because some programs model certain chemical species that others do not. Reduction of reject (waste) water was accomplished through the utilization of a calcite reactor and filter press followed by an additional UF RO stage on the first pass reject water. Final wastewater treatment design utilized IMSDesign software due to its expanded capabilities to model a wider range of metals (as shown on Table 2 “Permeate Water Quality Summary from Multiple Models” on the following page).

The four models generated the following data for permeate water quality (see Table 2 below). It should be noted that slight variations in final effluent quality from one program to another are the result of slight differences in the efficiency of the particular membranes chosen for the model. As per the scope of the Project these various modeling programs were utilized to determine the final permeate quality achievable. Final membrane selection will be based on Mine Water Service’s field experience with similar water quality and include, for example, Hydranautics CPA7-LD low fouling spiral wound membranes for final modeling and plant design.



Table 2. Permeate Water Quality Summary from Multiple Models

Analyte	Units	Method Detection Limit	Target Effluent Quality Average MG/L	Target Effluent Quality Highest Single Analysis Result MG/L	Influent Water Quality (Highest Half Mile Value) MG/L	Modeling Program			
						hyd-RO-Dose	Wave	Winflows	IMSDesign
TOTAL ALKALINITY	MG/L as CaCO <sub>3</sub>	0.7	6.92	9.2	Not Reported	0			
PHENOLPHTHALEIN ALKALINITY	MG/L as CaCO <sub>3</sub>	0.7	0.7	Not Detectable	Not Reported	0			
BICARBONATE ALKALINITY	MG/L	1.3	Not Reported	Not Reported	Not Reported	0.000	1.39	2.170	0.677
CARBONATE ALKALINITY	MG/L	1.3	Not Reported	Not Reported	Not Reported	0.000	0.000	0.000	0.000
TOTAL PHOSPHORUS	MG/L	0.01	0.020	0.04	0.04	0.000	0.000	0.010	0.000
TDS	MG/L	10	38.5	51	Not Reported	0.28	1.420	5.090	0.970
TSS	MG/L	2.5	4.5	9.7	12	0.000	0.000	0.000	0.000
MERCURY	MG/L	0.0002	0.0002	Not Detectable	Not Reported				
ALUMINUM	MG/L	0.005	0.1767	0.28	0.358	0.000			0.000
ANTIMONY	MG/L	0.0002	0.00045	0.0014	0.0009	0.000			
ARSENIC	MG/L	0.0002	0.00042	0.0009	0.005				0.000
BARIUM	MG/L	0.003	0.0062	0.009	0.021	0.000	0.000	0.000	0.000
BERYLLIUM	MG/L	0.0002	0.0002	Not Detectable	Not Detectable				
BORON	MG/L	0.02	0.02	0.02	0.196	0.000	0.000		0.014
CADMIUM	MG/L	0.00002	0.000132	0.00014	0.0477				0.000
CALCIUM	MG/L	0.1	2.81	3.6	91.8	0.05	0.000	0.170	0.000
CHROMIUM	MG/L	0.002	0.002	Not Detectable	Not Detectable				
COBALT	MG/L	0.0003	0.0003	0.0003	0.151				0.0000
COPPER	MG/L	0.0001	0.00116	0.01	0.383	0.000958			0.000
IRON	MG/L	0.02	0.232	0.56	6.02	0.000		0.000	0.000
LEAD	MG/L	0.0001	0.00018	0.0005	0.0257				0.000
LITHIUM	MG/L	0.0001	0.00029	0.0005	0.0037				0.000
MAGNESIUM	MG/L	0.1	0.67	0.9	7.17	0.000		0.050	0.000
MANGANESE	MG/L	0.002	0.0334	0.075	1.27				0.000
MOLYBDENUM	MG/L	0.005	0.005	Not Detectable	Not Detectable				0.000
NICKEL	MG/L	0.002	0.002	Not Detectable	0.013				0.000
POTASSIUM	MG/L	0.1	0.28	0.4	5.92	0.000	0.000	0.120	0.004
RUBIDIUM	MG/L	0.0005	0.0005	Not Reported	0.0149				
SELENIUM	MG/L	0.00006	0.00006	Not Reported	0.002				
SILICON	MG/L	0.02	1.93	3	2.6	0.000	0.000	0.040	0.000
SILVER	MG/L	0.0003	0.0003	Not Detectable	Not Detectable				
SODIUM	MG/L	0.1	0.99	1.2	25	0.010	0.000	1.060	0.261
STRONTIUM	MG/L	0.0003	Not Reported	Not Reported	0.25				0.000
SULFUR	MG/L	1	1.05	1.4	3	0.06		0.003	0.000
THALLIUM	MG/L	0.0001	0.0002	0.0008	Not Detectable				
ZINC	MG/L	0.0002	0.00768	0.045	10				0.004
CHLORIDE	MG/L	0.3	0.512	0.62	Not Reported	0.13	0.000	1.280	0.000
FLUORIDE	MG/L	0.03	0.03	Not Detectable	Not Reported				
NITRATE AS N	MG/L	0.1	0.1	Not Detectable	Not Reported			0.016	0.009
NITRITE AS N	MG/L	0.03	0.03	Not Detectable	Not Reported				
PH	STU	0.01	6.712	6.30 - 7.04 (Range)	7.5	5.76	4.600	5.230	8.140
SPECIFIC CONDUCTANCE	µS/CM	25	26.6	28	732	1.12	9.000	10.000	<10
SULFATE	MG/L	0.6	1.9	2.7	Not Reported	0.000	0.000	0.000	0.000
TOC	MG/L	0.7	10.06	12	Not Reported				
DOC	MG/L	0.7	9.49	12	Not Reported				
TOTAL CYANIDE	MG/L	0.005	0.0136	0.015	Not Reported				
TURBIDITY	NTU	0.1	3.91	9.7	21.2	0	0.000	0.000	0.000
TRUE COLOR		5	48	70	Not Reported	0	0.000	0.000	0.000

1. Empty cells indicate that that specific program does not model that analyte.
2. Minor variations in final water quality from one program to another is due to performance variations in the particular suppliers' membranes.

It should be noted that certain species are not modelled by any of the programs and that certain species were not included in the baseline or Half Mile analytical analysis. A brief description of these species follows.

- Modeling programs automatically adjust chloride, sodium or sulfate to modify input water chemistry to produce a water that is balanced in total anion and cation molar concentration. For this reason, in some instances, chloride, sodium or sulfate concentrations in permeate or concentrate water may not



be exactly equal to the theoretical values based on input water analysis chemistry. An example of this can be found in the Winflows chloride value in Table 2.

- Various alkalinities were not tested for certain samples, and in the case of Half Mile only total alkalinity was reported. Alkalinity in water takes into account natural bicarbonate, carbonate and hydroxide ions and is an equilibrium reached based on carbon dioxide adsorption and buffering capacity of the water. Alkalinity can vary dramatically in water based on rainfall, temperature, and seasonal variability especially associated with ice cover of surface waters. Alkalinity variability will not have any impact on the proposed treatment process or results achievable for all other metals and species present.
- TDS (Total Dissolved Solids) represents the sum of dissolved metals and other species in water and is not required or relevant in modeling UF RO system removal efficiency.
- Mercury was not reported in the Half Mile report and was therefore not modeled. It should be noted however that the IMSDesign program does model mercury removal and imputing mercury concentration at 0.1 mg/l resulted in a permeate mercury residual of not detectable when modeled.
- Rubidium is not currently modeled by any modeling programs due to the infrequent occurrence of rubidium in waters. Removal efficiency of rubidium is expected to be similar to that of strontium based on their similar atomic weights (rubidium = 85.5, strontium = 87.6). Available literature<sup>14</sup> indicates strontium removal utilizing RO ranges from 99.7% to 100% for a single pass. Anticipated removal efficiency for the Pickett Mountain two pass system would therefore be essentially 100%.
- Selenium is not currently modeled by any modeling programs however published literature<sup>15</sup> indicates that rejection rates for selenium are expected to be 90% to 95% for a single pass RO. This indicates a rejection rate in the two-pass Pickett Mountain plant of 99% to 99.75%.
- Sulfate was not reported however low-level sulfate was added to the models representing background sulfate levels.
- TOC (Total Organic Carbon) and DOC (Dissolved Organic Carbon) were not reported for the Half Mile samples and were therefore not modeled.
- Cyanide was not reported for Half Mile samples and was therefore not modeled.
- True color was not reported for Half Mile and was not modeled.

---

<sup>14</sup>Cai, Y.-H.; Yang, X.J.; Schäfer, A.I. Removal of Naturally Occurring Strontium by Nanofiltration/Reverse Osmosis from Groundwater. *Membranes* **2020**, *10*, 321. <https://doi.org/10.3390/membranes10110321>

<sup>15</sup> Abejón, R. A Bibliometric Analysis of Research on Selenium in Drinking Water during the 1990–2021 Period: Treatment Options for Selenium Removal. *Int. J. Environ. Res. Public Health* **2022**, *19*, 5834. <https://doi.org/10.3390/ijerph19105834>



Table 3. Anticipated Final Treated Water Quality (IMSDesign)

Analyte	Units	Method Detection Limit	Target Effluent Quality Average MG/L	Target Effluent Quality Highest Single Analysis Result MG/L	Influent Water Quality (Highest Half Mile Value) MG/L	Modeling Program				Final Expected Water Treatment Plant Effluent Quality MG/L
						hyd-RO-Dose	Wave	Winflows	IMSDesign	
TOTAL ALKALINITY	MG/L as CaCO <sub>3</sub>	0.7	6.92	9.2	Not Reported	0				
PHENOLPHTHALEIN ALKALINITY	MG/L as CaCO <sub>3</sub>	0.7	0.7	Not Detectable	Not Reported	0				
BICARBONATE ALKALINITY	MG/L	1.3	Not Reported	Not Reported	Not Reported	0.000	1.39	2.170	0.677	0.677
CARBONATE ALKALINITY	MG/L	1.3	Not Reported	Not Reported	Not Reported	0.000	0.000	0.000	0.000	Not Detectable
TOTAL PHOSPHORUS	MG/L	0.01	0.020	0.04	0.04	0.000	0.000	0.010	0.000	Not Detectable
TDS	MG/L	10	38.5	51	Not Reported	0.28	1.420	5.090	0.970	0.970
TSS	MG/L	2.5	4.5	9.7	12	0.000	0.000	0.000	0.000	Not Detectable
MERCURY	MG/L	0.0002	0.0002	Not Detectable	Not Reported					
ALUMINUM	MG/L	0.005	0.1767	0.28	0.358	0.000			0.000	Not Detectable
ANTIMONY	MG/L	0.0002	0.00045	0.0014	0.0009	0.000				Not Detectable
ARSENIC	MG/L	0.0002	0.00042	0.0009	0.005				0.000	Not Detectable
BARIUM	MG/L	0.003	0.0062	0.009	0.021	0.000	0.000	0.000	0.000	Not Detectable
BERYLLIUM	MG/L	0.0002	0.0002	Not Detectable	Not Detectable					Not Detectable
BORON	MG/L	0.02	0.02	0.02	0.196	0.000	0.000		0.014	Not Detectable
CADMIUM	MG/L	0.00002	0.000132	0.00014	0.0477				0.000	Not Detectable
CALCIUM	MG/L	0.1	2.81	3.6	91.8	0.05	0.000	0.170	0.000	Not Detectable
CHROMIUM	MG/L	0.002	0.002	Not Detectable	Not Detectable					Not Detectable
COBALT	MG/L	0.0003	0.0003	0.0003	0.151				0.0000	Not Detectable
COPPER	MG/L	0.0001	0.00116	0.01	0.383	0.000958			0.000	Not Detectable
IRON	MG/L	0.02	0.232	0.56	6.02	0.000		0.000	0.000	Not Detectable
LEAD	MG/L	0.0001	0.00018	0.0005	0.0257				0.000	Not Detectable
LITHIUM	MG/L	0.0001	0.00029	0.0005	0.0037				0.000	Not Detectable
MAGNESIUM	MG/L	0.1	0.67	0.9	7.17	0.000		0.050	0.000	Not Detectable
MANGANESE	MG/L	0.002	0.0334	0.075	1.27				0.000	Not Detectable
MOLYBDENUM	MG/L	0.005	0.005	Not Detectable	Not Detectable				0.000	Not Detectable
NICKEL	MG/L	0.002	0.002	Not Detectable	0.013				0.000	Not Detectable
POTASSIUM	MG/L	0.1	0.28	0.4	5.92	0.000	0.000	0.120	0.004	Not Detectable
RUBIDIUM	MG/L	0.0005	0.0005	Not Reported	0.0149					Not Detectable
SELENIUM	MG/L	0.00006	0.00006	Not Reported	0.002					Not Detectable
SILICON	MG/L	0.02	1.93	3	2.6	0.000	0.000	0.040	0.000	Not Detectable
SILVER	MG/L	0.0003	0.0003	Not Detectable	Not Detectable					Not Detectable
SODIUM	MG/L	0.1	0.99	1.2	25	0.010	0.000	1.060	0.261	0.261
STRONTIUM	MG/L	0.0003	Not Reported	Not Reported	0.25				0.000	Not Detectable
SULFUR	MG/L	1	1.05	1.4	3	0.06		0.003	0.000	Not Detectable
THALLIUM	MG/L	0.0001	0.0002	0.0008	Not Detectable					Not Detectable
ZINC	MG/L	0.0002	0.00768	0.045	10				0.004	0.004
CHLORIDE	MG/L	0.3	0.512	0.62	Not Reported	0.13	0.000	1.280	0.000	Not Detectable
FLUORIDE	MG/L	0.03	0.03	Not Detectable	Not Reported					Not Detectable
NITRATE AS N	MG/L	0.1	0.01	Not Detectable	Not Reported			0.016	0.009	Not Detectable
NITRITE AS N	MG/L	0.03	0.03	Not Detectable	Not Reported					Not Detectable
PH	STU	0.01	6.712	6.30 - 7.04 (Range)	7.5	5.76	4.600	5.230	8.140	8.180
SPECIFIC CONDUCTANCE	µS/CM	25	26.6	28	732	1.12	9.000	10.000	<10	<10
SULFATE	MG/L	0.6	1.9	2.7	Not Reported	0.000	0.000	0.000	0.000	Not Detectable
TOC	MG/L	0.7	10.06	12	Not Reported					
DOC	MG/L	0.7	9.49	12	Not Reported					
TOTAL CYANIDE	MG/L	0.005	0.0136	0.015	Not Reported					
TURBIDITY	NTU	0.1	3.91	9.7	21.2	0	0.000	0.000	0.000	Not Detectable
TRUE COLOR		5	48	70	Not Reported	0	0.000	0.000	0.000	Not Detectable

The above modeling results (Table 3) indicate that the proposed treatment plant design will be able to meet existing water quality at the Pickett Mountain site.



## **Water Treatment Facility Design**

The conceptual facility design for the Project is as follows and presented on Figure 7,

1. Surface contact water from the collection/storage pond is fed to the water treatment plant at a rate of 205 USGPM.
2. Feed water passes through a ceramic UF unit for removal of suspended solids.
3. Filtrate is then fed to the first of two stages of RO.
4. Permeate from the first stage RO is fed to the second stage RO.
5. Second stage RO permeate is final effluent (treated water) and is produced at a rate of 200 USGPM.
6. Second stage wastewater (concentrate) is recycled to the first stage RO feed at a rate of 22 USGPM.
7. First stage RO wastewater (concentrate) reports to a reactor where lime (CaO) is added to precipitate excess calcium and alkalinity as calcite (calcium carbonate –  $\text{CaCO}_3$ ) which is removed via filtration and becomes a solid waste material (filter cake). Filter cake volume is anticipated to be 2.6 cubic feet per day (2.9 cubic yards per month) The media filter cake is defined as a special waste under Maine’s Solid Waste Management Rules, Chapter 400, and will be transported and disposed of in conformance with those rules.
8. Reactor overflow water reports to a second UF RO system (concentrate recovery system) at a rate of 58 USGPM.
9. Permeate from the concentrate recovery UF RO system is recycled to the primary UF feed at a rate of 50 USGPM along with calcite filter filtrate at a rate of 3.5 USGPM.
10. Final wastewater (concentrate) exits the plant at a flow rate of 5 USGPM.

Based on the proposed plant design the full capacity water balance is as follows,

Mine Impacted Water Treatment Plant Feed	= 205 USGPM
Final Permeate (Treated) Water to Discharge	= 200 USGPM
Wastewater	= 5 USGPM

Figure 7. Proposed Plant Process Flow Diagram

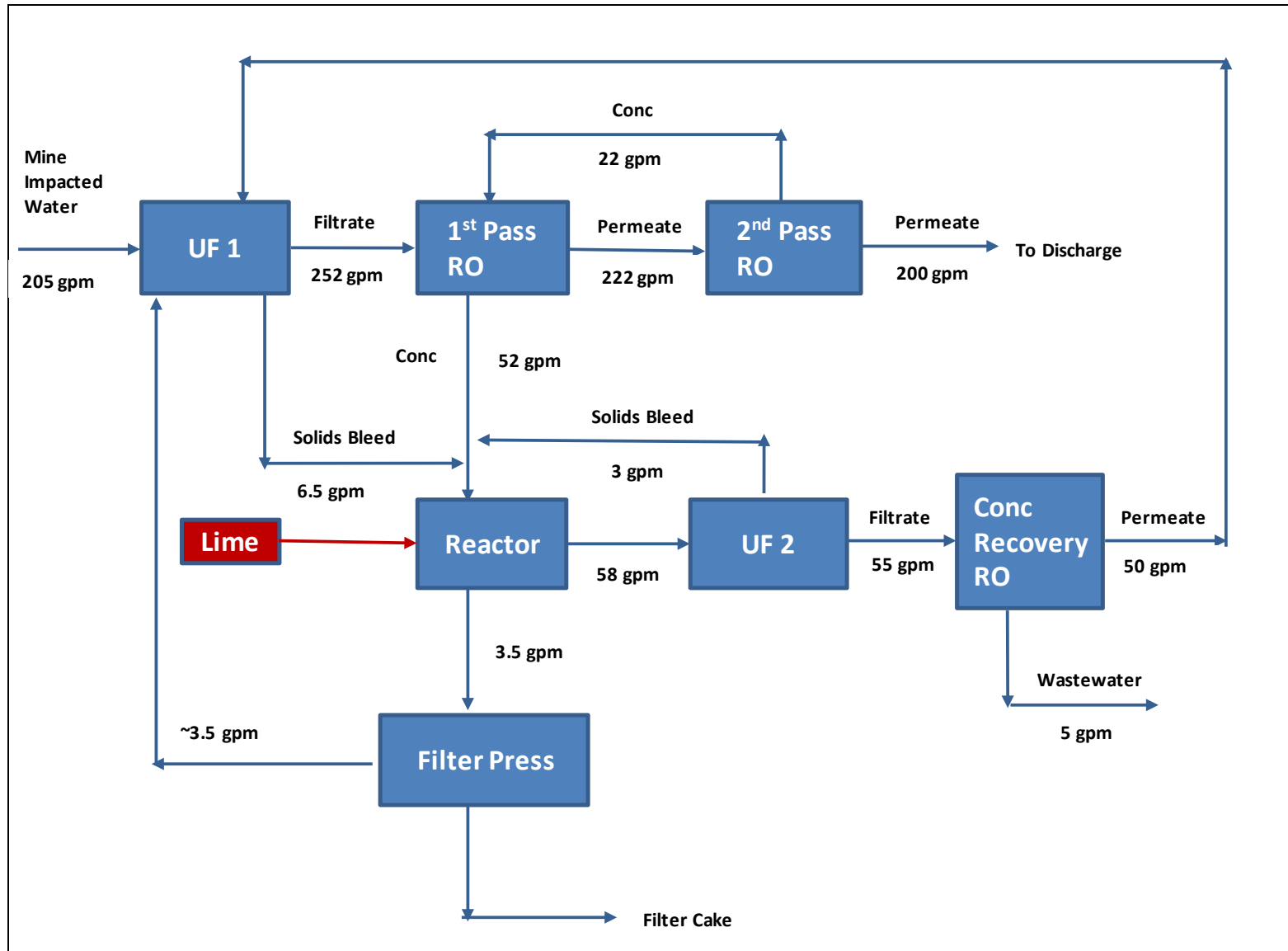



The proposed treatment plant will result in an overall mass balance (Table 4).

Table 4. Mass Balance

Analyte	Units	Target Effluent Quality MG/L	Final Plant Clean Water @ 200 USGPM	Final Plant Waste Stream @ 5 USGPM
TOTAL ALKALINITY	MGCACO3/L	6.92		
PHENOLPHTHALEIN ALKALINITY	MGCACO3/L	0.7		
BICARBONATE ALKALINITY	MG/L		0.677	27.757
CARBONATE ALKALINITY	MG/L		0.004	0.164
TOTAL PHOSPHORUS	MG/L	0.02	Not Detectable	1.64
TDS	MG/L	42.7	1.660	
TSS	MG/L	4.5	Not Detectable	492
MERCURY	MG/L	0.0002		
ALUMINUM	MG/L	0.1767	Not Detectable	14.678
ANTIMONY	MG/L	0.00045	Not Detectable	0.0369
ARSENIC	MG/L	0.0004	Not Detectable	0.205
BARIUM	MG/L	0.0062	Not Detectable	0.861
BERYLLIUM	MG/L	0.0002	Not Detectable	Not Detectable
BORON	MG/L	0.02	Not Detectable	8.036
CADIUM	MG/L	0.000132	Not Detectable	1.9557
CALCIUM	MG/L	2.81	Not Detectable	3763.8
CHROMIUM	MG/L	0.002	Not Detectable	Not Detectable
COBALT	MG/L	0.0003	Not Detectable	6.191
COPPER	MG/L	0.00116	Not Detectable	15.703
IRON	MG/L	0.232	Not Detectable	246.82
LEAD	MG/L	0.00018	Not Detectable	1.0537
LITHIUM	MG/L	0.00029	Not Detectable	0.1517
MAGNESIUM	MG/L	0.67	Not Detectable	293.97
MANGANESE	MG/L	0.0334	Not Detectable	52.07
MOLYBDENUM	MG/L	0.005	Not Detectable	0.0943
NICKEL	MG/L	0.002	Not Detectable	0.533
POTASSIUM	MG/L	0.28	Not Detectable	242.72
RUBIDIUM	MG/L	0.0005	Not Detectable	0.6109
SELENIUM	MG/L	0.005	Not Detectable	0.082
SILICON	MG/L	1.93	Not Detectable	106.6
SILVER	MG/L	0.0003	Not Detectable	Not Detectable
SODIUM	MG/L	0.99	0.281	1025
STRONTIUM	MG/L	0.0003	Not Detectable	
SULFUR	MG/L	1.05	Not Detectable	123
THALLIUM	MG/L	0.0002	Not Detectable	Not Detectable
ZINC	MG/L	0.00768	0.004	410
CHLORIDE	MG/L	0.512	Not Detectable	41
FLUORIDE	MG/L	0.03	Not Detectable	
NITRATE AS N	MG/L	0.1	Not Detectable	203.2
NITRITE AS N	MG/L	0.03	Not Detectable	
PH	STU	6.3 - 7.04 (Range)	8.140	8.18
SPECIFIC CONDUCTANCE	µS/CM	26.6	<10	30012
SULFATE	MG/L	1.9	Not Detectable	110.7
TOC	MG/L	10.06		492
DOC	MG/L	9.49		492
TOTAL CYANIDE	MG/L	0.0136		0.615
TURBIDITY	NTU	3.91	Not Detectable	869.2
TRUE COLOR		48	Not Detectable	2870





## Plant Sizing

The water treatment plant size proposed is based on peak monthly treatment volumes as described in the technical memorandum “Proposed Pickett Mountain Mine Project Precipitation Runoff Collection Areas - Mine Only Option” dated May 23, 2022 and revised August 25, 2022, prepared by Wood PLC Engineering consultants and prepared by Wood PLC Engineering consultants. Table 5 below provides a summary of the anticipated runoff flows summarized in this technical memorandum, with the peak or highest flow months highlighted in red (Table 5). Treatment plant sizing is based on the highest monthly estimated flow of 6.57 million gallons which equates to 152.08 USGPM. Normal contingency factors added to water treatment plant designs range from 20% to 30% and a 30% excess flow contingency was used for design of the Pickett Mountain plant. The proposed treatment plant is therefore sized to discharge treated water at the anticipated peak monthly flow with a 30% additional contingency capacity which equates to 197.71 USGPM which was rounded up to 200 USGPM.

Total annual estimated runoff volume is 43.73 million gallons which equates to a nominal treatment rate of 119,808.2 gallons per day or 83.2 USGPM. Based on an optimized waste stream flow of 5 USGPM at full plant capacity the annual wastewater volume is expected to be 1,075,200 gallons per year (2.13 USGPM at 83.2 USGPM permeate production rate). It should also be noted that the proposed UF RO design for the Pickett Mountain plant is modular in nature. While the proposed plant is currently sized to accommodate peak flows as per the table below should further study result in changes to anticipated flows the proposed plant design can easily be modified to accommodate any anticipated flow.

Table 5. Peak Monthly Runoff Flows

Jan	Feb	Mar	Apr	May	Jun	Jul	Aug	Sept	Oct	Nov	Dec
<b>Average Precipitation in Inches</b>											
3.28	2.57	3.07	3.85	4.02	3.81	4.08	3.99	4.02	4.27	4.38	3.69
<b>Runoff Volume in Million Gallons</b>											
2.22	1.72	2.07	2.29	2.41	2.26	2.45	2.39	2.41	2.59	2.67	2.51
<b>Assumed Runoff Factor Due to Temperature</b>											
0.15	0.10	0.70	2.30	1.60	1.00	1.00	1.00	1.00	1.00	0.95	0.90
<b>Estimated Runoff Volume Adjusted for Temperature in Million Gallons</b>											
0.33	0.17	1.45	5.28	3.87	2.26	2.45	2.39	2.41	2.59	2.54	2.26
<b>30 GPM Mine Dewatering Monthly Volume in Million Gallons</b>											
1.34	1.21	1.34	1.30	1.34	1.30	1.34	1.34	1.30	1.30	1.30	1.34
<b>Total Monthly Treatment Volume in Million Gallons</b>											
1.67	1.38	2.79	6.57	5.20	3.56	3.79	3.73	3.71	3.89	3.84	3.60

Blue: Winter Months - frozen conditions with reduced runoff.

Grey/Blue: Late Fall-Early Winter or Late Winter- Early Spring - some reduced runoff.

Green: Spring months - increased runoff with snow melt.



## **Pre and Post Production Water Management**

Water management during the construction phase of the Project will entail water collection, storage, treatment and discharge but with reduced volumes due to a reduced site footprint resulting in reduced collection and water treatment requirements. Water will be collected from the waste rock storage pad and the storage ponds. Water from these pads and ponds will be collected and treated as if it was contaminated. After treatment through the water treatment plant, effluent will be discharged into the Post -Treatment Water Storage Pond, tested, then discharged into the surrounding groundwater via infiltration galleries. Reject water from the water treatment plant will be pumped back into the large Pre-Treatment Water Storage Pond where it will mix with additional impacted water collected from the site.

Approximately 32% of the site assets will not be established until near production. The headframe and associated pads will not be developed until 3 years post startup of the project. This means that prior to start up and well into production the actual water requiring collection for treatment will be less than the projected maximum volume. Prior to start up, with development of site assets representing only 68% of the total site footprint, the precipitation requiring collection and treatment represents 29,750,000 gallons of water over a 12-month construction/preproduction period (68% of the total projected annual volume of 43.73 million gallons). This represents a nominal treatment plant clean water production rate of 56.58 USGPM which will result in a nominal reject water rate of 1.414 USGPM.

The total volume of stored water capacity in the pre water treatment storage pond is projected to be 6,870,000 Gallons. Over the duration of 1 full year pre-production (at 68% asset development), the maximum reject water produced is 743,410 gallons or 10.82% of the total volume of the pond. The total volume of water requiring treatment in the first year of operation can be treated with the proposed water treatment plant in 104 days at peak design flow.

Chemical and mineral loading in the 743,410 gallons of stored reject water will be minimal due to continued dilution from precipitation. After the first construction year and when production and backfilling commence, this stored water will be treated again, and contaminants further concentrated. Final concentrates can then be used in the mining process as backfill cement mix water as described in the next section of this report.

Postproduction impacted water will continue to be collected in the pre water treatment storage pond, processed through the water treatment plant and stored in the Post-Treatment Water Storage Pond, tested and once verified to meet existing water quality will be discharged into the surrounding groundwater via infiltration galleries. It is anticipated that once production ceases eventual dilution from natural precipitation will result in the site impacted water reaching background quality without the requirement for treatment. In the case that this is incorrect, water treatment will take place until a small volume of wastewater remains in storage. This water can then be collected and removed from site to be stored at a certified water management facility or evaporated until only solids remain, which would then be removed and disposed of in an approved landfill.



## **Water Treatment Plant Waste Water Management**

The proposed treatment plant will produce, at peak flow, 5 USGPM of wastewater which will be directed to the Pre-Treatment Water Storage Pond within the Pickett Mountain Site. Wastewater will be stored until backfill production commences and will then be used to prepare cement to be utilized for backfill placement underground as a means of ground stabilization. Annual water treatment requirements for the Pickett Mountain Site are projected to be 43.73 million gallons which equates to an average water treatment plant permeate production rate of 83.2 USGPM (utilizing 365 days per year plant operation) during production. Wastewater production from the plant at this treatment rate will be 2.13 USGPM or 3,072 US gallons per day based on the Wood PLC Engineering study cited above.

Backfill production is based on the use of cemented rock fill with an anticipated fill placement rate of 6.6 tons per day of rock placement and 5% cement binder content. Daily water requirements for cement preparation are estimated to be 6,340 US gallons. Daily wastewater production from the UF RO plant is projected to be 3,072 US gallons. This means that all wastewater generated from the RO plant can be used for cement production during production.

## **Reagent Use and Final Disposition**

Various chemical reagents are employed to treat the various membrane systems for scale and deposit control as well as required periodic cleaning. While cleaning frequency can't be determined until the plant is in actual operation MWS's experience with UF RO plants treating similar quality water indicates that cleaning frequency will likely be less than monthly and more likely quarterly for first stage UF and first and second stage RO. Cleaning frequency for the brine recover UF (UF 2) and RO will be slightly more frequent due to the nature of the water being treated at this stage of the process however anticipated frequency would still be not more than monthly. All chemicals are applied to the influent side of the UF and RO system and therefore report to the wastewater side of the process. In all cases, the reagents do not represent a hazard for downstream use of wastewater in the Pickett Mountain operations. The anticipated maximum consumption of reagents that will be utilized in operation of the plant are outlined below in Table 6.



Table 6. Water Treatment Plant Anticipated Reagent Use

Reagent	Composition	Purpose	Addition Point	Dosage (mg/l)	Anticipated Monthly Consumption at Peak Flow	Anticipated Monthly Consumption at Nominal Flow
Sodium Hydroxide	Sodium hydroxide 50%	RO stage 2 feed pH adjustment	RO stage 2 feed	110	6,820 lb.	3,290 lb.
Lime	CaO 100%	Calcite reactor	Calcite reactor	TBD	TBD	TBD
Osmonix WL3000 or BWA Flocon 885 Antiscalant or similar	Proprietary (Biodegradable)	Scale control for RO membranes	RO stage 1 feed	5	351.5 lb.	150 lb.
Disinfectant	Sodium hypochlorite (bleach)	Biofouling cleaning of UF	UF chemically enhanced backwash	Periodic - weekly	125 lb.	125 lb.
Low pH Cleaner	Hydrochloric or Citric acid 10%	RO membrane cleaning	RO clean In place	Periodic - monthly	20 lb.	20 lb.
Alkaline Cleaner	Sodium hydroxide 10%	RO membrane cleaning	RO clean In place	Periodic - monthly	20 lb.	20 lb.

Note: Monthly consumption based on peak plant flow.

All chemical reagents utilized in the operation of the plant ultimately report to the waste stream and will not pass through the RO membranes to end up in the final permeate discharge water. While all wastewater generated from the water treatment plant will be utilized for cement preparation it should be noted that even prior to this the reagents will be eliminated through natural reactions in the wastewater holding pond. The sodium hydroxide, low pH cleaner and alkaline cleaner will naturally decompose to form sodium chloride (table salt) and water. Sodium hypochlorite will degrade naturally to form, once again, sodium chloride and water. The proprietary antiscalant is biodegradable<sup>16</sup> and contains no components that would be harmful to people or the environment.

In addition to periodic cleaning both UF and RO membranes are periodically replaced due to wear and in some cases fouling due to inorganic scale formation which results in reduced flow rates and excessive operating pressure. The proposed plant design will include a high degree of instrumentation allowing the operators to monitor membrane performance and schedule membrane replacements prior to any operational impact on the plant. Membranes which are replaced can be safely disposed of in landfill.

### **Re-Mineralization**

In many instances, treated water from RO plants is re-mineralized prior to discharge to the environment to add back constituents in to enhance the discharge water quality. In the case of the Pickett Mountain Project, this remineralization could be undertaken to add calcium and alkalinity to provide levels equal to the background water quality targets. Remineralization is accomplished by adding calcium, normally in the form of calcium chloride, and alkalinity normally in the form of sodium carbonate.

Remineralization is easily included in the overall water treatment plant design and control systems. Instrumentation included in the plant design will automatically calculate and adjust addition rates of calcium chloride and sodium carbonate based on plant operating rate to achieve calcium and alkalinity targets. The

<sup>16</sup> <http://www.dormeco.co.il/wp-content/uploads/2012/12/Flocon-885.pdf>



need for and amount of remineralization will be determined in conjunction with the Chapter 200 permitting for the Project.

Anticipated remineralization reagent usage is as follows (Table 7).

Table 7. Anticipate Re-Mineralization Reagent Requirements

Reagent	Composition	Purpose	Addition Point	Dosage (mg/l)	Anticipated Monthly Consumption at Peak Flow	Anticipated Monthly Consumption at Nominal Flow
Calcium Chloride	CaCl <sub>2</sub> 32%	Addition of calcium to final effluent	Final effluent	50	3,515 lb.	1,496 lb.
Sodium Carbonate	Na <sub>2</sub> CO <sub>3</sub> 100%	Addition of alkalinity to final effluent	Final effluent	50	3,515 lb.	1,496 lb.





## **Appendix 1. Wolfden Supplied Input and Existing Water Quality**



## Input Water Quality (Half Mile Mine)

Analyte	Units	Influent Water Quality (Highest Half Mile Value) MG/L
TOTAL ALKALINITY	MG/L as CaCO <sub>3</sub>	Not Reported
PHENOLPHTHALEIN ALKALINITY	MG/L as CaCO <sub>3</sub>	Not Reported
BICARBONATE ALKALINITY	MG/L	Not Reported
CARBONATE ALKALINITY	MG/L	Not Reported
TOTAL PHOSPHORUS	MG/L	0.04
TDS	MG/L	Not Reported
TSS	MG/L	12
MERCURY	MG/L	Not Reported
ALUMINUM	MG/L	0.358
ANTIMONY	MG/L	0.0009
ARSENIC	MG/L	0.005
BARIUM	MG/L	0.021
BERYLLIUM	MG/L	Not Detectable
BORON	MG/L	0.196
CADMIUM	MG/L	0.0477
CALCIUM	MG/L	91.8
CHROMIUM	MG/L	Not Detectable
COBALT	MG/L	0.151
COPPER	MG/L	0.383
IRON	MG/L	6.02
LEAD	MG/L	0.0257
LITHIUM	MG/L	0.0037
MAGNESIUM	MG/L	7.17
MANGANESE	MG/L	1.27
MOLYBDENUM	MG/L	Not Detectable
NICKEL	MG/L	0.013
POTASSIUM	MG/L	5.92
RUBIDIUM	MG/L	0.0149
SELENIUM	MG/L	0.002
SILICON	MG/L	2.6
SILVER	MG/L	Not Detectable
SODIUM	MG/L	25
STRONTIUM	MG/L	0.25
SULFUR	MG/L	3
THALLIUM	MG/L	Not Detectable
ZINC	MG/L	10
CHLORIDE	MG/L	Not Reported
FLUORIDE	MG/L	Not Reported
NITRATE AS N	MG/L	Not Reported
NITRITE AS N	MG/L	Not Reported
PH	STU	7.5
SPECIFIC CONDUCTANCE	µS/CM	732
SULFATE	MG/L	Not Reported
TOC	MG/L	Not Reported
DOC	MG/L	Not Reported
TOTAL CYANIDE	MG/L	Not Reported
TURBIDITY	NTU	21.2
TRUE COLOR		Not Reported

Water Sampling Locations and Existing Water Quality – Pickett Mountain Site







## **Appendix 2. Individual Modeling Program Data – Two Pass Primary Treatment**





Hyd-RO-dose



**hyd-RO-dose®**

**WATER CHEMISTRY SUMMARY  
AT 75.0 % RECOVERY**

Report Date: 06-06-2022    Sampled: 06-06-2022  
 Sample ID: 0                                  at 1658

<b>CATIONS (mg/L)</b>	<b>Raw</b>	<b>Feed</b>	<b>Product</b>	<b>Brine</b>
Calcium(as Ca)	2.04	2.04	0.05	8.00
Magnesium(as Mg)	0.16	0.16	0.00	0.63
Barium(as Ba)	0.00	0.00	0.00	0.00
Strontium(as Sr)	0.00	0.00	0.00	0.00
Sodium(as Na)	0.56	0.56	0.01	2.20
Potassium(as K)	0.13	0.13	0.00	0.51
Lithium(as Li)	0.00	0.00	0.00	0.00
Iron(as Fe)	0.13	0.13	0.00	0.51
Ammonia(as NH <sub>3</sub> )	0.00	0.00	0.00	0.00
Aluminum(as Al)	0.01	0.01	0.00	0.04
<b>ANIONS (mg/L)</b>				
Chloride(as Cl)	5.03	5.03	0.13	19.72
Sulfate(as SO <sub>4</sub> )	0.06	0.06	0.00	0.24
Dissolved CO <sub>2</sub>	0.0	0.0	0.0	0.0
Bicarbonate	0.2	0.2	0.0	0.7
Carbonate	0.0	0.0	0.0	0.0
Silica(as SiO <sub>2</sub> )	0.14	0.14	0.00	0.55
Phosphate(as PO <sub>4</sub> )	0.00	0.00	0.00	0.00
H <sub>2</sub> S (as H <sub>2</sub> S)	0.00	0.00	0.00	0.00
Fluoride(as F)	0.00	0.00	0.00	0.00
Nitrate(as NO <sub>3</sub> )	0.01	0.01	0.00	0.04
Boron(as B)	0.00	0.00	0.00	0.00
<b>PARAMETERS</b>				
pH	7.00	7.00	5.76	7.84
Temperature (°C)	25.00	25.00	25.00	25.00
Calculated T.D.S.	8.59	8.59	0.28	33.70
Calculated Cond.	19.22	19.22	1.12	73.79

**French Creek Software, Inc.**  
**1220 Valley Forge Road, Suite 21, Valley Forge, PA 19460**

Wave



Concentrations (mg/L as ion)						
	Feed	Concentrate		Permeate		
		Stage1	Stage2	Stage1	Stage2	Total
NH <sub>4</sub> <sup>+</sup>	0.07	0.14	0.55	0.00	0.00	0.00
K <sup>+</sup>	0.01	0.02	0.09	0.00	0.00	0.00
Na <sup>+</sup>	0.04	0.08	0.33	0.00	0.00	0.00
Mg <sup>+2</sup>	0.00	0.01	0.04	0.00	0.00	0.00
Ca <sup>+2</sup>	0.06	0.11	0.44	0.00	0.00	0.00
Sr <sup>+2</sup>	0.00	0.00	0.00	0.00	0.00	0.00
Ba <sup>+2</sup>	0.00	0.00	0.00	0.00	0.00	0.00
CO <sub>3</sub> <sup>-2</sup>	0.00	0.00	0.00	0.00	0.00	0.00
HCO <sub>3</sub> <sup>-</sup>	1.72	2.07	4.81	1.38	1.39	1.39
NO <sub>3</sub> <sup>-</sup>	0.00	0.00	0.00	0.00	0.00	0.00
F <sup>-</sup>	0.00	0.00	0.00	0.00	0.00	0.00
Cl <sup>-</sup>	0.00	0.00	0.00	0.00	0.00	0.00
Br <sup>-1</sup>	0.00	0.00	0.00	0.00	0.00	0.00
SO <sub>4</sub> <sup>-2</sup>	0.00	0.00	0.00	0.00	0.00	0.00
PO <sub>4</sub> <sup>-3</sup>	0.00	0.00	0.00	0.00	0.00	0.00
SiO <sub>2</sub>	0.01	0.02	0.06	0.00	0.00	0.00
Boron	0.01	0.03	0.09	0.00	0.00	0.00
CO <sub>2</sub>	57.61	58.28	59.42	56.90	57.63	57.24
TDS*	1.96	2.50	6.42	1.41	1.42	1.41
Cond. µS/cm	8	8	10	9	9	9
pH	4.7	4.8	5.2	4.6	4.6	4.6

Footnotes:

\*Total Dissolved Solids Includes Ions, SiO<sub>2</sub> and B. It does not include NH<sub>3</sub> and CO<sub>2</sub>



## Winflows

SUEZ Water Technologies & Solutions					
Winflows Version 4.04		DataBase Version 4.04			
Streams Analytical Data					
Ions, mg/l		Raw Feed	RO1 Element Feed	DownStream Perm RO1	RO1 Concentrate
Calcium (Ca)		83.00	83.00	0.17	276.36
Magnesium (Mg)		25.00	25.00	0.05	83.24
Sodium (Na)		106.00	106.00	1.06	350.97
Potassium (K)		8.00	8.00	0.12	26.39
Ammonia - N (NH4)		2.00	2.00	0.11	6.42
Barium (Ba)		0.05	0.05	0.00	0.17
Strontium (Sr)		0.10	0.10	0.00	0.33
Iron (Fe)		1.00	1.00	0.00	3.33
Manganese (Mn)		0.10	0.10	0.00	0.33
Sulfate (SO4)		3.00	3.00	0.00	9.99
Chloride (Cl)		303.61	303.61	1.28	1009.33
Fluoride (F)		1.00	1.00	0.01	3.30
Nitrate (NO3)		5.00	5.00	0.07	16.51
Bromide (Br)		0.00	0.00	0.00	0.00
Phosphate (PO4)		1.00	1.00	0.01	3.32
Boron (B)		0.00	0.00	0.00	0.00
Silica (SiO2)		5.00	5.00	0.04	16.57
Hydrogen Sulfide (H2S)		0.00	0.00	0.00	0.00
Bicarbonate (HCO3)		145.78	145.78	2.17	479.45
Carbon Dioxide (CO2)		20.53	20.53	20.43	21.34
Carbonate (CO3)		0.10	0.10	0.00	1.11
TDS, mg/l		689.73	689.73	5.09	2287.12
Flow	gpm	351.09	351.09	245.80	105.30
Temperature	°C	25.00	25.00	25.00	25.00
Pressure	psi	0.00	148.40	0.00	91.55
Hardness	ppm as CaCO3	310.23	310.23	0.62	1032.95
Density	kg/m3	997.49	997.49	997.00	998.63
Ionic Strength		0.01	0.01	0.00	0.05
Osm. Pressure	psi	6.72	6.72	0.22	21.27
pH		7.00	7.00	5.23	7.45
Conductivity at 25°C	µS/cm	1268.00	1268.00	10.00	3939.00
<b>Saturation Data</b>					
BaSO4	%	6.34	6.34	0.00	25.02
CaF2	%	10.09	10.09	0.00	<b>223.43</b>
CaSO4	%	0.10	0.10	0.00	0.43
SiO2	%	3.99	3.99	0.02	13.20
SrSO4	%	0.01	0.01	0.00	0.03
Struvite	%	0.00	0.00	0.00	0.03
LSI		-0.37	-0.37	-6.47	0.80
S&DI		-0.71	-0.71	-6.98	0.72



IMSDesign

Ion (mg/l)	Raw Water	Feed Water	Permeate Water	Concentrate
Hardness, as CaCO3	256.89	236.43	0.000	471.7
Ca	91.00	83.76	0.000	419.6
Mg	7.17	6.60	0.000	33.1
Na	25.53	34.21	0.261	168.0
K	5.96	5.62	0.004	27.5
NH4	0.01	0.01	0.000	0.0
Ba	0.021	0.019	0.000	0.1
Sr	0.250	0.230	0.000	1.2
Zn+2	10.000	9.200	0	46.103
CO3	0.68	13.53	0.004	23.0
HCO3	392.00	384.74	0.677	1898.8
SO4	3.00	2.76	0.000	13.8
Cl	1.00	0.92	0.000	4.6
NO3	10.00	9.32	0.009	46.1
PO4	0.04	0.04	0.000	0.2
OH	0.00	0.16	0.011	0.0
SiO2	2.60	2.40	0.000	12.0
B	0.20	0.24	0.014	0.9
CO2	21.12	19.43	0.01	19.43
NH3	0.00	0.00	0.00	0.00
<b>TDS</b>	<b>549.46</b>	<b>553.60</b>	<b>0.97</b>	<b>2694.98</b>
<b>pH</b>	<b>7.50</b>	<b>7.53</b>	<b>8.14</b>	<b>8.18</b>

STATE OF MAINE  
DEPARTMENT OF AGRICULTURE, CONSERVATION & FORESTRY  
LAND USE PLANNING COMMISSION

IN THE MATTER OF	)	Pre-Filed Direct Testimony of Don
REZONING PETITION ZP 779A	)	Dudek on Behalf of Wolfden Mt.
WOLFDEN MT. CHASE, LLC	)	Chase, LLC

On behalf of Wolfden Mt. Chase, LLC (“Wolfden”), Don Dudek, P. Geo. is submitting this pre-filed direct testimony in support of ZP 779A.

**I. QUALIFICATIONS AND EXPERIENCE**

I am the Vice President Exploration of Wolfden Resources Corporation since July of 2020. I am a Professional Geologist of Ontario, Canada since March 2004 with previous professional registrations in the provinces of Alberta, Saskatchewan and Manitoba during the period from 1985 to 2003. I also served on the grandfathering committee when Professional Geoscientists were initially required to register in Manitoba. I have a Bachelor of Arts in Geology with Honors from the University of Saskatchewan (1982), Saskatoon, Saskatchewan, Canada.

My work experience includes the following:

- **1979 to 1982 Geological Assistant to Project Geologist**, Western Canada.
- **1983 to 1989 Consultant Project Geologist** - focused on gold and base metal projects in Canadian Arctic and the Province of Manitoba. Our work resulted in the discovery two new gold deposit and one new base metal. One of the gold deposits was subsequently mined.
- **1989 to 1985 – Project Geologist and exploration office manager for Noranda Mining and Exploration.** Focused on base metal and gold exploration in Western Canada.
- **1985 to 2007 – Project Geologist to Exploration Manager North and Central America for Aur Resources Inc.** – focused on base metal projects until company taken over by Teck Resources.



- **2008 to 2012 – Senior Vice President Exploration for Avion Gold Corp.** – part of team that recommended acquisition and re-development of a historic gold mine in Mali. West Africa. Discovered Houndé Gold deposit which contained >5 million ounces of gold. Was directly involved in promotion and financing of over CDN\$100 million, to support mine development and exploration. Company was purchased by Endeavour Mining in 2012.
- **2012 -2014 – Senior Vice President Technical Services for Endeavor Mining** – Managed the feasibility study of the Houndé Gold deposit including development of environmental and social license and Burkina Faso Government ESG review.
- **2014 to 2019 – President and CEO Savary Gold Corp.** – Managed all corporate and exploration strategies until sold to Semafo in 2019. Raised \$12 million for field work which resulted in the discovery and delineation of over 700,000 ounces of gold.

Additionally, I have served in the following roles:

- **Desert Gold – Director, Technical consultant from 2017 to current**
- **Omai Gold Mines Inc. – Director and Chairman from 2022**
- **Sierra Grande Minerals Inc. – Strategic advisor 2021 to current**
- **Roscan – Director, Technical consultant from 2018 to 2020**
- **Alder Resources Ltd. – Chairman, Director and President & CEO 2011-2016**
- **Sulliden Gold Corporation Ltd. – Director to 2015**
- **Avion Gold Corporation – Director June 2008 to January 2011**
- **Bell Copper Corporation – Director June 2011 to April 2012**

## II. INVOLVEMENT WITH THE PICKETT PROJECT

In early 2020 I was contracted to review the geology and potential formation of the Pickett Mountain Project. After the visit, I was appointed to Wolfden’s Technical Advisory Board and later moved into the role as Wolfden’s Vice President of Exploration for U.S.A projects. My team and I designed and managed exploration programs at Pickett Mountain from 2020 through to mid-2022. This work led to an update of the geological model and an increase in the mineral resource estimate.

The goals of the exploration programs on and near the Pickett Mountain deposit were to delineate and discover additional mineralization, improve our understanding of the mineralized system and to better define the formation of the mineralized zones. This work resulted in a new

geological/structural/geochemical model in early fall 2021 to better define the mineralization, alteration and associated geological setting. The new model resulted in an increase in overall mineral resources and an improved understanding of the geology and associated alteration zones, as reported in a press release on November 17, 2021.

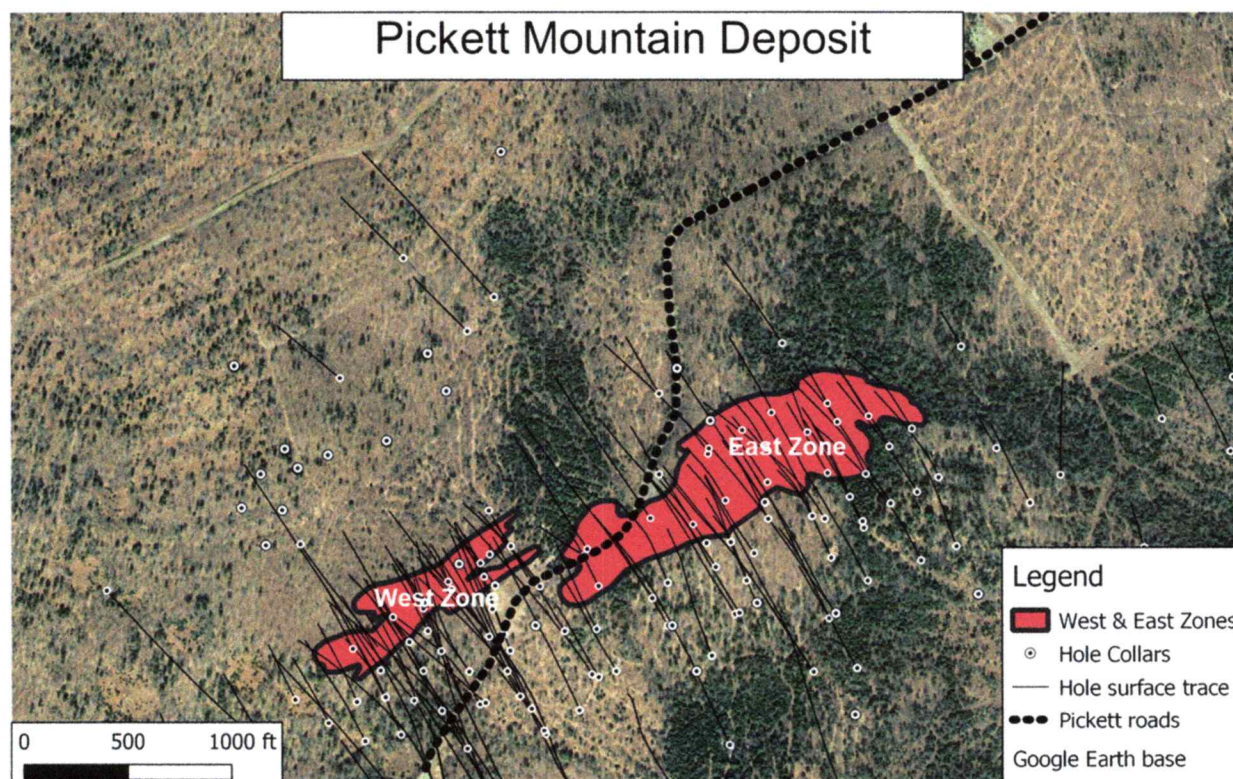

Analytical and observational data were collected for 204 core holes totaling over 165,000 feet. In addition to assay samples collected to document metal content, an additional 1,849 lithochemical samples were analyzed for major oxides and up to 63 trace elements to document rock type and alteration. This data, while not directly measuring a rock's ability to produce acid under the right conditions, does provide a very good indication, along with detailed rock descriptions, if a rock could potentially contribute to acid mine drainage. An additional seven samples of footwall and hanging wall rocks were collected in 2021 to test their ability to produce acid if exposed to air and water as reported by Botha and Cheung (2021). Observational



data comprises detailed to generalized descriptions of the various rock units encountered in all drill holes with greater detail in holes logged by Wolfden. This data forms part of the local and regional technical records of information gathered to date for the project.

As a result of my work experiences, I am very familiar with most geological, geochemical and geophysical aspects of this deposit type. The Pickett Mountain deposit is, in general, a typical volcanogenic massive sulphide deposit with a cross-cutting footwall alteration zone and cap rocks that preserved this sub-seafloor mineral deposit. The deposit is special due to its generally high grades, which are likely related to the nuances of its formation.

### **III. POTENTIAL FOR ACID MINE DRAINAGE**

Acid rock drainage is a process that occurs when minerals that contain sulfide react with oxygen and water to produce sulfuric acid. This sulphuric acid would then have the potential to leach metals from the adjacent rocks if they are sulphide-bearing. The most common mineral that causes acid rock drainage is pyrite (iron sulfide,  $\text{FeS}_2$ ). Pyrite is a component of the Pickett Mountain deposit ores and West Zone footwall alteration zone. Other minerals that can contribute to acid rock drainage include aluminosilicate and iron-rich carbonates – based on preliminary drill core results, these do not appear to be a factor at the Pickett Mountain deposit.

From a mining point of view, the shape of the sulphide zone and the character of the adjacent rocks will determine how the material is mined and the potential for acid rock drainage. My work, in part, focuses on defining the chemistry of the deposit and surrounding rock, which in turn informs the potential for and how to mitigate acid rock drainage. The West Zone is nearly vertical and generally has a strong footwall alteration zone. Alteration in this context refers to changes in the overall chemistry of the original rock units by subsequent metal-rich hydrothermal fluids which passed through the rocks and created the West Zone directly and East

Zone indirectly. In this case, strong alteration indicates that the original rocks chemistry was strongly modified and weak alteration indicates that the original rock chemistry was weakly modified. Rocks that are moderately to strongly altered are more likely to contain minerals (iron sulphides and iron carbonates), that, if exposed to air and water, could result in the formation of acidic fluids that could leach metals out of the nearby rocks.

The East Zone, dips steeply to moderately to the south with a generally non-existent footwall alteration (limited to no pyrite or iron carbonates) zone. Rocks on the hanging wall, are generally not sulphide-bearing or altered, with testwork to date indicating that they would not generate acid during weathering.

A preliminary Acid Base Accounting (“ABA”) study was performed on seven (7) samples taken from representative areas within waste rock where development drifts and raises are currently planned. Five (5) samples were taken from drill holes in the footwall of the orebody and two (2) samples were taken from the hanging wall. A range of rock types were selected for the ABA work, including mafic volcanics, felsic volcanics, and mafic intrusives. Preliminary acid base accounting (‘ABA’) test work indicates that the West Zone footwall would be acid generating if exposed to air and water, which is consistent with visual observations. The data is mixed for the footwall of the East Zone with two samples exhibiting non-acid generating characteristics and one sample exhibiting weak potential for acid generation. Overall, the north side of the East Zone is only weakly hydrothermally altered or sulphide-bearing and is not expected to generate acid if exposed to air and water. In addition to the ABA samples, we will plan several samples for humidity cell testwork that is longer term testwork that accounts for the delay or gap between air and water exposure and acid generation from a specific sample. These samples will be guided by early stage acid base accounting tests.

All samples of the hanging wall rocks or rocks to the south of the West and East Zone deposits that were subjected to ABA testing, did not exhibit potential to generate acid, which was expected since the rocks did not display hydrothermal alteration and were not sulphide-bearing. Additional ABA test work of the rocks to the north of the known zones, especially under the East Zone, will be carried out. However, both geochemical and observational data indicates that the underground infrastructure proposed to access the West and East Zone deposits, could be located where the existing ABA testing, visual observations and lithochemical sample results, indicate there is no potential to generate acid.

Note that the goal of the ABA sampling, geological observations and lithochemical data, is to provide information for detailed mine planning specifically regarding where underground infrastructure could be installed to minimize or eliminate any potential for acid mine drainage.

A more comprehensive Metal Leaching and Acid Rock Drainage (“MLARD”) study will be completed once fresh core has been collected from an infill drill program planned to take place during the Chapter 200 application process. Additional samples will be collected in ore, waste rock, and low-grade ore, including typical rock types to be encountered during underground development and production. Most of the underground development is currently designed in the footwall of the orebody; however, final detailed mine design will be completed once additional MLARD samples are analyzed, and geo-mechanical drilling programs have taken place. The near-vertical geometry of the deposit allows for some flexibility with mine design, such that the most appropriate locations, geochemically and geotechnically, will be selected for underground development. Low-grade ore will be handled like higher-grade ore. It can be processed on its own and still produce an incremental profit or it can be blended with



higher grade “pods” of ore to generate a consistent mill feed grade. If low-grade ore is not consumed throughout the life of the operation, it is processed through the concentrator before closure and reclamation begin.

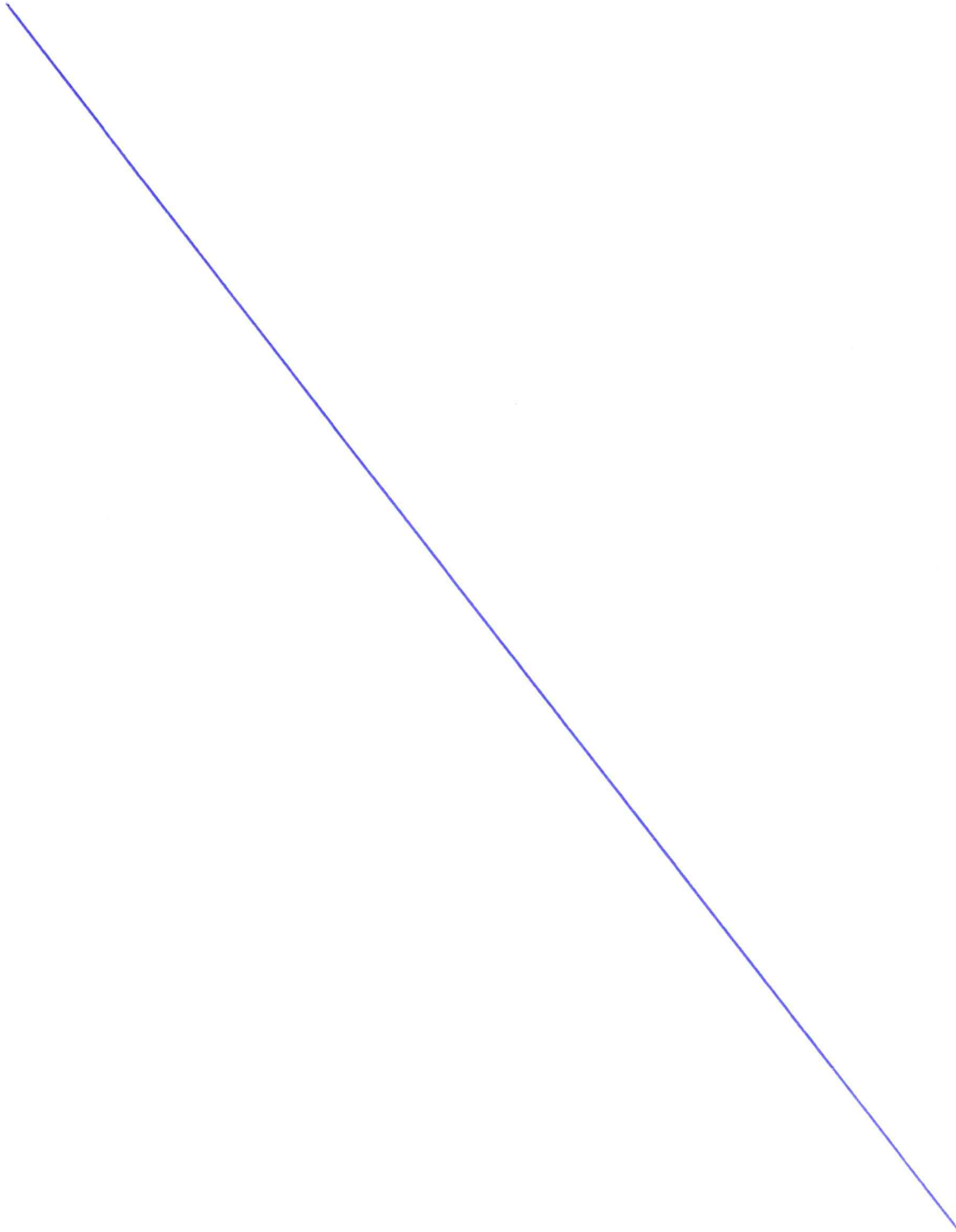

Dated: Sept. 20, 2023

  
Don Dudek

Signed at Georgetown, ON

Date: September 20, 2023

Personally appeared before me the above-named Don Dudek, who, being duly sworn, did testify that the foregoing testimony was true and correct to the best of his knowledge and belief.

Before me,

Witnessed as to execution only.

No advice sought or given.



Notary Public

My commission expires: does not expire

**Kuldip Kahlon-Gill**  
**Licensed Paralegal, No. P19328, and Commissioner**  
Province of Ontario  
My Commission **does not expire.**

**ARNOLD, FOSTER LLP**  
Barristers & Solicitors  
232A Guelph Street, Suite 201  
Georgetown, Ontario L7G 4B1



STATE OF MAINE  
DEPARTMENT OF AGRICULTURE, CONSERVATION & FORESTRY  
LAND USE PLANNING COMMISSION

IN THE MATTER OF	)	Pre-Filed Direct Testimony of Jim
REZONING PETITION ZP 779A	)	Finley on Behalf of Wolfden Mt.
WOLFDEN MT. CHASE, LLC	)	Chase, LLC

On behalf of Wolfden Mt. Chase, LLC (“Wolfden”), Jim Finley, Ph.D., P.G. is submitting this pre-filed direct testimony in support of ZP 779A.

**I. QUALIFICATIONS AND EXPERIENCE**

I am a Principal Geochemist with Stantec Consulting Services, Inc. I hold a Doctor of Philosophy in Geology from the University of Wyoming (1992) with an emphasis in geochemistry and am a Professional Geologist (Wyoming) since 1996. I have worked in the hard-rock mining industry for 27 years providing geochemical services to all stages of the mine life cycle from green-fields material characterization and water quality prediction through mine reclamation and closure. I have project experience with both underground and open pit operations for mines located in North and South America, Australia, and New Zealand.

My work experience includes the following:

- **1993 to 1996 – Assistant Professor of Geology**, Miami University, Oxford, Ohio.
- **1996 to 1999 – Geochemist**, Shepherd Miller, Inc.
- **2000 to 2001 Geochemist**, Geotrans, Inc.
- **2001 to 2014 – President**, Telesto Solutions, Inc .
- **2014 to Present – Principal Geochemist**, Stantec Consulting Service, Inc. –

My curriculum vitae is attached as Exhibit A.

### **III. INVOLVEMENT WITH THE PICKETT PROJECT**

I am providing testimony specific to the question of the viability of implementing a mining plan for the Project that will meet the requirements of Maine's stringent mining law and, in particular, prevent degradation of surface or groundwater quality. My testimony is drawn mainly from my experience in planning and conducting geochemical characterization programs that provide necessary background data to support permitting, but that also continues beyond mine permitting into mine operations, reclamation, and closure.

### **IV. ACID ROCK DRAINAGE AND METAL LEACHING**

Acid rock drainage (ARD) and metal leaching (ML) arise when mineralized rock is extracted from the ground and is exposed to air and water at the surface and exposed surfaces in the underground. In hard-rock ore deposits, the geological processes leading to formation of an economic ore body also deposit other minerals, specifically pyrite (or "fool's gold"), that are an integral part of geochemical characterization for purposes of assessing the potential for ARD/ML and evaluating potential impacts of the mining process to the environment.

The intent of an ARD/ML geochemical characterization program is to collect samples of all rock types that will be intersected by the mining operation and conduct laboratory testing to classify various rock materials as to the potential to generate ARD and/or ML. Chapter 200<sup>1</sup> specifies classification of mine rock as Class A (mine waste that has acid-generating potential or exhibits a characteristic of hazardous waste as defined in 06-096 C.M.R. ch. 850), Class B (mine waste has no acid-generating potential and may release soluble pollutants at concentrations which exceed performance requirements for groundwater or surface water), or Class C (mine waste does not have the potential to violate water quality standards other than sedimentation or

---

<sup>1</sup> Maine Department of Environmental Protection. 2017. Chapter 200: Metallic Mineral Exploration, Advanced Exploration and Mining. Available at: <http://www.maine.gov/sos/cec/rules/06/096/096c200.docx>.

turbidity) that captures the range of geochemical properties of non-ore (waste) rock. How the mine rock is managed during mining and in reclamation/closure depends on the geochemical classification of the rock. The geochemical characterization program is typically tied closely to the mine development plan such that the volume of each rock type is also determined, as the volume of rock in each classification is important in understanding just what type of management plan is needed to limit the geochemical reactivity of various ARD/ML rock types. Well-researched and thorough references for developing effective geochemical characterization programs are available.<sup>2</sup>

An equally important part of the geochemical characterization program is the assessment of the capability of the mine rock to neutralize ARD and limit ML. Just as the ARD focus is mainly on the presence of the mineral pyrite, the neutralization capacity of the same mine rock is mainly focused on the presence of the mineral calcite. Think of calcite as the Alka-Seltzer of minerals. Most folks at some point in time have mixed vinegar (an acidic liquid) with baking soda (a neutralizing solid) and observed the bubbling that accompanies the reaction. When mixed in the right proportions, the final liquid is no longer acidic. The same principle applies to the balance of how much potential acidity is contained in mine rock versus how much potential neutralization is contained in the same rock. The balance between total acidity and total neutralizing capacity is the basis for the Acid Base Accounting (ABA) analysis. Results of ABA testing address the question related to the potential of different mine rocks to produce acid rock

---

<sup>2</sup> See International Network for Acid Prevention. 2014. *Global Acid Rock Drainage Guide* (available at: <http://www.gardguide.com>); Waste Rock, Overburden, and Ore Characterization and Evaluation – Guidance Document. 2020. Bureau of Mining Regulation and Reclamation, Nevada Department of Environmental Protection. August 30.



drainage. Generally speaking, a rock is considered non-potentially acid generating if the amount of neutralizing capacity is three times larger than the acid generating potential.

Acid base accounting is a so-called static test in that the measurement considers only total amounts of potential acid generation and neutralizing capacity. An additional important consideration, one that is specified in the Chapter 200 rules is the question of time period before onset of ARD would occur. That is, after rock is excavated and exposed to air and water, how long before ARD might occur, or would ARD occur at all. Would the production of ARD occur within a few months or years? The question of how long before onset of ARD is important in the context of the mining operation because if the mine plan would either consume the rock or otherwise store the rock before the onset of ARD, then the potential for ARD would be addressed. There are laboratory and field-scale tests that generate the information needed to address the question of timing. Either laboratory humidity cell tests or field-scale bin tests both expose mine rock to air and water with periodic rinsing and measurement of the rinse water chemistry to provide time-dependent information about potential geochemical reactions. In either the HCT or field bin, the resulting water chemistry accounts for the combined effects of ARD and neutralization.

Additional characterization of the rock minerals, through mineralogical analysis, provides important information about what types of minerals are present, and what minerals are likely to contribute to ARD and neutralizing capacity. Chapter 200, section 20(E)(2)(b) requires this kind of mineralogical analysis as part of the baseline information needed to support a mine permit.

## **V. PICKETT MOUNTAIN PROJECT AND GEOCHEMISTRY**

Underground mining at the Pickett Mountain Project will generate much less mine rock than the more common open pit mining, which, while not understating concerns about ARD/ML,

means more availability for implementing a geochemical characterization program. Because ARD/ML does not occur without water, a general description of groundwater in the context of geochemistry is provided.

Advancing the underground workings will require temporarily (duration of active mining) lowering the groundwater table that will result in creating a depression in the local groundwater system. Because water flows downhill, as long as the depression in the groundwater system exists, groundwater will flow into the mine workings. When mining is finished, the pumps used in support of mining will be turned off and the groundwater depression will slowly fill until re-establishing pre-pumping groundwater levels. Detailed evaluation of differences between shallow and deep groundwater will be further investigated as part of the Chapter 200 baseline analysis.

From the perspective of geochemistry, there is need to characterize the geochemical properties of the rock excavated and describe how the rock will be managed at the surface both during mining and following reclamation. In the current mine plan, a portion of the mine rock will be returned to the underground as a means to provide ground support for the mining operation. A portion of the mine rock backfill will have added cement (i.e., neutralizing material) that adds to the geomechanical properties of the placed rock. Mine rock will be placed back into the mine workings, though will remain temporarily at the surface during mining. Detailed mine material management plans will be developed during the Chapter 200 process.

The geochemistry of the mine rock is important to following during active mining to know the geochemical properties of rock placed underground. Currently available geochemical data support the feasibility of designing mine access development in non-acid generating rock.

Thus, there is good reason to continue the geochemical characterization program beyond the baseline and permitting period.

Regarding the underground mine workings, mapping and geochemical sampling of mine wall rock will confirm the geochemical properties of rock exposed in the mine openings. During mine development and active operations, the walls of the mine openings are exposed to air associated with the ventilation system required to support work underground. The combination of air and humidity from groundwater seepage in the underground openings generates conditions that could cause production of ARD/ML if the mine walls contain pyrite without accompanying minerals to contribute neutralizing capability. Should there be ARD/ML production in the mine walls due to the mineralogy of rock exposed, there could be a flush of ARD/ML materials during re-filling of the underground by groundwater at the end of mining. Again, characterizing the mine wall rock and developing a plan to address potential first flush conditions (i.e., acidity, sulfate, and metals) would be part of an ARD/ML management plan. The chemistry of mine water during the period of time that re-filling occurs could be effectively modified to address ARD/ML should that condition arise. Also, after groundwater refills the underground mine openings, there would no longer be production of ARD/ML because the groundwater effectively blocks air entry returning the submerged rock to an oxygen restricted environment eliminating the potential for reaction.

In terms of concerns related to geochemistry and potential for impacts to the surrounding surface and groundwater, the Pickett Mountain Project can be implemented and would achieve the performance standards outlined in Chapter 200 through implementation of a thorough geochemical characterization program that begins with background work, continues into and

through active mining, and evolves as the understanding of the rock geochemistry improves with time.

Dated: Sept. 19 2023

Jim B. Finley  
Jim B. Finley

STATE of Colorado

County of LaRimer

Date: 9/19/23

Personally appeared before me the above-named Jim B. Finley, who, being duly sworn, did testify that the foregoing testimony was true and correct to the best of his knowledge and belief.

Before me,

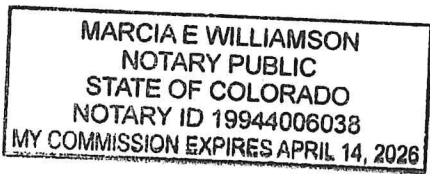

Marcia E Williamson  
Notary Public  
My commission expires: 4/14/26



# **EXHIBIT A**

Dr. Finley is based in Stantec's Fort Collins, Colorado office. He is a principal geochemist with over 25 years of experience in the application of geochemical and hydrological principles to address water quality and management issues in a variety of environments associated with natural resource extraction and use. He has worked in coal, uranium, and hard-rock mining for his consulting career completing projects in North and South America, New Zealand, and Australia. He has extensive experience in mining at all phases of the mine life cycle from baseline work in support of permitting, active agency interaction, preparation of EIS/EIA documents, support for active mine operations, and participation in analysis and design for reclamation and closure of mines. Dr. Finley has expertise in the following technical areas: aqueous geochemistry, geochemical modeling, isotope geochemistry and hydrology, trace metal chemistry, watershed hydrology, and dynamic systems modeling. He has also provided technical services as an expert witness regarding the influences of hydrology and geochemistry on surface and ground water chemistry.

## EDUCATION

Ph.D., Geology, University of Wyoming, Laramie, Wyoming, 1992

M.S., Geology/Hydrology, Colorado State University, Fort Collins, Colorado, 1984

BS, Forestry, University of Montana, Missoula, Montana, 1979

## REGISTRATIONS

Professional Geologist #PG-3079, State of Wyoming

## MEMBERSHIPS

Member, International Association of GeoChemistry

Member, Geological Society of America

## PROJECT EXPERIENCE

### Mining

Cerro Blanco, Guatemala (Principal Geochemist)

*Managed development implementation of a geochemical characterization program for a green-field gold mine. Required consideration of a historical dataset in development of a more robust, defensible geochemical testing program to support mine development. Program adjusted to reflect shift from an underground mine plan to an open pit mine that results in significantly more material remaining at surface.*

Climax Mine, Colorado (Principal Geochemist; Project Technical Lead)

*Lead a team of engineers and scientists to identify sources, potential source controls, and water treatment options for addressing molybdenum in water discharged from the facility. Served as the technical expert for interactions with the Colorado Water Quality Control Commission and Water Quality Control Division related to establishing a water quality standard for molybdenum in water supply.*

Platoro Mine, Colorado (Project Manager/Geochemist)

*Responsible for overall project and client management. Significant regulatory interaction with State and Federal agencies. Provide technical guidance on water management, water treatment, geochemistry, hydrogeology, site characterization and reclamation.*

Equity Mine, Houston, British Columbia (Principal Geochemist)

*Participated as a member of the Technical Review Board assembled to evaluate geochemical and geochemical conditions in the tailing dams at the Equity Mine. Conducted a field visit to observe conditions, reviewed technical documents related to annual tailing dam inspections and monitoring systems placed to continuously monitor conditions in the tailing dams. Also reviewed recent programs instituted to investigate conditions associated with the presence of potentially acid generating material that was placed in one of the dams. Assisted in writing a report of TRB finding for submission to the BC Provincial government.*

# Jim B. Finley Ph.D., PG

Principal Geochemist

---

## Gold Standard Ventures, Nevada (Principal Geochemist)

*Developed a geochemical characterization program to develop information in support of developing baseline characterization for a greenfield project. Also provided senior technical review of hydrogeological characterization program for determination of baseline conditions. Interfaced with state and federal regulatory agencies in development of characterization plans and following review of final reports.*

## Goldstrike Mine, Nevada (Principal Geochemist)

*Lead development of field and laboratory testing program to evaluate the geochemical reactions and products related to sulfide oxidation and low-level combustion of carbon-bearing rock. Interfacing with geotechnical team to consider influence of geochemical changes on geotechnical stability.*

## Marigold Mine, Nevada (Principal Geochemist)

*Prepare sections of a draft environmental impact statement for the planned mine expansion. Involved identifying and describing potential environmental impacts associated with the planned expansion.*

## Hycroft Mine, Nevada (Principal Geochemist)

*Prepare sections of a draft environmental impact statement for the planned mine expansion. Involved identifying and describing potential environmental impacts associated with the planned expansion.*

## Long Canyon Mine, Nevada (Principal Geochemist)

*Prepare sections of a draft environmental impact statement for the planned mine expansion. Involved identifying and describing potential environmental impacts associated with the planned expansion.*

## Gold Rush Mine, Nevada (Principal Geochemist)

*Prepare sections of a draft environmental impact statement for the planned mine expansion. Involved identifying and describing potential environmental impacts associated with the planned expansion.*

## Rhyolite Ridge Mine, Nevada (Principal Geochemist)

*Prepare sections of a draft environmental impact statement for the planned mine expansion. Involved identifying and describing potential environmental impacts associated with the planned expansion.*

## Safford Mine, Arizona (Dynamic Systems Modeler)

*Developed a dynamic systems model of a pit lake that will be formed under a new mine expansion. Model incorporated relevant hydrologic and geochemical processes to allow prediction of future pit lake chemistry. Results were used in the NEPA analysis of the project.*

## Florida Canyon Mine\*, Nevada (Geochemist)

*Conducted dynamic systems modeling to evaluate closure alternatives for the heap leach pad. Incorporated effects of dynamic climate, use of preg ponds for evaporation, and heap leach draindown chemistry to project future management of draindown solutions in closure.*

## Sleeper Mine\*, Nevada (Geochemist)

*Developed dynamic systems model of heap leach pad draindown to predict long-term drainage water quality. Evaluated use of preg ponds for evaporation of draindown solution, salt accumulation, and management requirements. Also conducted a geochemical characterization study of the tailing to identify options for closure of the tailing impoundment including predictions of long-term water chemistry.*

## Cyprus Tohono Mine\*, Arizona (Principal Geochemist)

*developed a dynamic systems model to predict long-term pit water chemistry based on chemical mass loading from multiple sources, effects from historical upset of heap leach solution (copper) to the pit lake, and effects of arid climate and evapoconcentration. Also conducted geochemical characterization of long-term heap leach draindown chemistry and resulting management options.*

## Cerro Verde Mine, Arequipa, Peru (Senior Technical Review – Geochemistry)

*Provided technical support for the interpretation of groundwater geochemistry and stable isotopes to evaluate a multi-year water chemistry and isotope data set in regard to the effectiveness of a water management system for a large tailings storage facility. Analysis included interpretation of groundwater and tailings solution chemistry, the application of geochemical modeling (PHREEQC) to understand mineral precipitation and dissolution, degree of mixing of native groundwater and tailings solution, and interpretation of stable isotopes of oxygen and hydrogen in water. Additionally provided geochemical services to assist in identifying probable native sources of elevated concentrations of chloride in the vicinity of a new tailings storage facility.*

\* denotes projects completed with other firms

## Jim B. Finley Ph.D., PG

Principal Geochemist

---

### San Luis Mine\*, San Luis, Colorado (Project Manager/Project Geochemist)

*Conducted geochemical and hydrogeologic evaluation of pit backfill materials, surrounding pit wall materials, and adjacent alluvial valley fill to determine the major processes controlling the rate of groundwater flow from a backfilled mine pit and the evolution of groundwater chemistry. Resulting data were used to predict rinsing times of pit backfill and assist in regulatory permitting. Also evaluated the potential for land application of groundwater that required analysis in support of a Supplemental Supply Plan for water rights and an evaluation of potential impact to the larger groundwater system by analysis of groundwater modeling results obtained from the Rio Grande Decision Support System's groundwater MODFLOW model. Responsible for overall project management. Successfully assisted in negotiating a resolution of the CDO/NOV from CDPHE and preventing further action by Region 8 EPA.*

### The GNWT Department of Infrastructure, Northwest Territories, Canada (Senior Technical Review)

*Provided senior technical and quality review of two reports that address ARD/ML properties of potential quarry rock for use in upgrading Highway 3 and 4.*

### Constancia Mine, Cusco, Peru (Principal Geochemist)

*Provided senior review of geochemical data and plans to place potentially acid generating material in the downstream shell of the tailing dam. Provided interface with the independent review board and guidance on additional studies that would produce information in support of the plan.*

### Freeport McMoRan NM, AZ, CO Operations\* (Expert Support Services – Geochemistry, Hydrology, Regulatory)

*Provided expert support in developing responses/comments for submission in the matter of potential new regulations imposed by the U.S. EPA regarding Financial Assurance determinations for hard rock mines. Developed text and worked with legal team to finalize response document.*

### Los Bronces Mine, Santiago, Chile (Principal Geochemist)

*Assisted in review of the current water management system to evaluate potential methods to optimize water use and metals recovery in the copper leach circuit. Additionally, the analysis also helped the client alter the water management system to minimize potential development pod scaling (mainly gypsum) in the system.*

### Nickel West IPS Study – Kalgoorlie Residue Ponds, Western Australia (Senior Technical Review – Geochemistry)

*Provide senior technical review of geochemical analysis conducted by a third party contractor to evaluate the potential for metal leaching mine materials to impact groundwater. Entailed review of technical report, evaluation of the analysis conducted, and summarizing comments in a technical memorandum.*

### Pogo Mine, Delta Junction, Alaska (Principal Geochemist)

*Developed a field investigation plan to gather information and water solids samples to identify the probable cause of biogenic slimes and blue-staining on mine walls in the underground mine. Conducted a field visit to observe and sample features. Managed laboratory analyses of water and solids sample, evaluated resulting laboratory information and prepared a technical memorandum to address client objectives.*

### KSM Mine, Northwest British Columbia (Principal Geochemist)

*Participated in a major design review of water rock facilities associated with the planned KSM project. The objective of the review was to identify potential methods for limiting sulfide oxidation in the waste pile at all states of the facility development. Provided technical input as to methods applicable to limit the sulfide oxidation reaction.*

### Tyrone Mine, Silver City, New Mexico (Technical Lead)

*Acting a technical lead in conducting a pre-feasibility and feasibility study for implementing water treatment into the mine water management system. The tasks include conducting a pre-feasibility evaluation of potential water disposal options for treatment effluent to select a preferred option, then carrying the selected option through full feasibility-level study.*

\* denotes projects completed with other firms

## Jim B. Finley Ph.D., PG

Principal Geochemist

---

### Hardrock Mine, Geraldton, Ontario (Senior Technical Review – Geochemistry)

*Provided technical review of documents created to establish baseline conditions and to evaluate potential impacts to the environment from development of a gold mine. Major challenge with the mine plan is providing a realistic evaluation of likely water quality conditions of the pit lake that will develop after mine closure. Closure objective is to create a permanently stratified pit lake to sequester mine runoff in the deep portion of the lake.*

### New Mine Project, Monument Bay, Northern Ontario (Senior Technical Review – Geochemistry)

*Provided technical support for development and implementation of a geochemical characterization program for a new mine project in northern Ontario. Geochemical information will be used to develop a baseline characterization report for use in conducting an environmental assessment of the mine plan.*

### Pierina Mine, Peru (Senior Technical Review – Geochemistry)

*Provided technical expertise in geochemistry and hydrology as part of a team conducting a closure readiness review. Evaluation of technical studies conducted in support of development of a closure plan as well as evaluating the need for any additional technical studies. The project team addressed all facets of closure requirements related to regulatory and internal closure standards.*

### Grasberg Mine, Nola, Indonesia (Senior Technical Review – Geochemistry)

*Provided third-party technical review of permitting documents that analyze potential environmental impacts associated with long-term storage of sulfide concentrate. Focus of review was on components of the plan affected by geochemical processes as influenced by the plan for disposal and storage of material that measures about 82 percent by weight pyrite. Information included standard and modified kinetic testing data, methods to incorporate geochemical modeling directly in a GoldSim™ model and review of geochemical testing data of tailing cover material used in final closure.*

### Prohibition Mine, Waiuta, New Zealand (Project Geochemist)

*Served as project geochemist working with engineers and environmental scientists to conduct a feasibility evaluation of closure options for an historical mine site in the northwest of New Zealand's south island. Historical mining and processing produced a localized environment where soils contain up to 40 percent (by weight) of arsenic. After selection of the best option that met the closure objectives, the remedy was completed.*

### New Mexico Operations\*, New Mexico (Expert Witness – Geochemistry)

*Provided expert witness testimony on portions of the Copper Rule that involved geochemistry (waste rock facilities, pit lakes and tailings facilities). Member of a team of experts that helped get the rule passed by the New Mexico Water Quality Control Commission.*

### Polymet Mine\*, Minnesota (Senior Technical Review – Geochemistry)

*Provided third-party technical review for geochemical modeling incorporated into the dynamic systems model used for project analysis.*

### Idaho Cobalt Project\*, Idaho (Project Manager/Project Geochemist/Dynamic Systems Modeler)

*Lead geochemist project manager providing baseline hydrologic and geochemical characterization in support of a NEPA evaluation, lead developer of a dynamic systems model coupled with the PHREEQC geochemical model to evaluate potential impacts to the environment related to discharge of mine water to a receiving stream, lead technical representative for proponent during interactions with the U.S. Forest Service, Idaho Department of Environmental Quality and Region 10 EPA. Product served as basis for the EIS/ROD issued by the US Forest Service.*

\* denotes projects completed with other firms



# Jim B. Finley Ph.D., PG

Principal Geochemist

---

## Golden Sunlight Mine\*, Montana (Project Geochemist/Dynamic Systems Modeler)

*Participated in a program to complete geochemical characterization of waste rock to determine changes in mineralogy, and grain size, associated with sulfide oxidation. Conducted geochemical characterization of tailings materials in combination with a geotechnical and hydrologic evaluation to predict long-term tailing drawdown chemistry. Produced summary technical documents that were used in completing an SEIS. Assisted in development of a dynamic systems model of the tailings facility that is used to track the mine process water balance.*

## El Galeno Project\*, Peru (Project Geochemist/Project Manager)

*Project manager for implementing a geochemical characterization program testing mine rock materials based on the current mine plan. Testing included standard static test procedures (ABA, MWMP, NAG) and humidity cell testing. Results of geochemical testing were used in developing conceptual geochemical models (including use of PHREEQC) of project facilities and in making predictions of drainage water chemistry for use in completing the ESIA and BFS for the mine plan.*

## Oil & Gas

### Mahogany Project\*, Piceance Basin, Colorado (Project Manager/Geochemist)

*Served in role of project coordinator for baseline environmental studies in anticipation of commercializing the pilot-scale testing of in situ conversion of oil shale. Oversaw five specialized consulting companies and coordinated schedules within the larger, overall project schedule. Conducted geochemical characterization of the regional Piceance Basin groundwater system based on water chemistry data obtained from groundwater monitoring wells. Was lead author and technical analyst for an isotope study that included both stable and radiogenic isotopes to further interpret groundwater flow and geochemical evolution of groundwater in the Piceance Basin.*

## MTBE Biodegradation Study, Martinez, California (Senior Technical Review – Geochemistry)

*Provided support to the interpretation of geochemical data collected as part of a field-scale evaluation of natural attenuation. An historical leak of MTBE to a shallow groundwater aquifer caused development of a plume. Natural attenuation, via a coupled microbially-mediated oxidation of the hydrocarbon using inorganic constituents, was evaluated through sampling of groundwater and evaluation of both the geochemistry and microbiology of the groundwater.*

## Industrial

### Indirect Potable Reuse Feasibility Study, Elsinore, California (Project Geochemist)

*Conducted geochemical modeling and water chemistry analysis to evaluate the potential effects of deep aquifer injection of treated effluent. Evaluation considered the ambient chemistry of groundwater, historical injection programs and the chemistry of the treated effluent. Geochemical modeling was conducted to determine the potential for mineral formation that might affect the overall efficiency of the potable reuse program. Additionally, an evaluation was completed regarding the potential for deep well injection activities to influence the concentration of arsenic in the deep aquifer; historical water quality data demonstrate that arsenic exists in the aquifer and an important condition of the potable reuse plan is to minimize the potential for additional mobilization of arsenic.*

### Read Boyd Farm, Upper Chichester, Pennsylvania (Principal Geochemist)

*Provided technical input for interpreting soil and groundwater geochemical processes influencing groundwater chemistry in the vicinity of sludge ponds containing acidic waste material from petroleum refining. Provided input to development of a geochemical testing program to determine soil and aquifer geochemical properties that influence groundwater chemistry. Developed a dynamic systems model using GoldSim® to incorporate groundwater flows and geochemical processes to evaluate potential options to aid in achieving regulatory water chemistry standards in the adjacent Marcus Hook Creek.*

\* denotes projects completed with other firms

Jim B. Finley Ph.D., PG

Principal Geochemist

---

#### Coal Combustion Residuals Services

(Principal Geochemist)

*Provided geochemical services to team evaluating sources of arsenic in groundwater adjacent to pond containing coal combustion residue. Reviewed site development history, geochemical analyses of residue materials, and groundwater chemistry. Conducted geochemical modeling to assess the potential effect of aquifer material properties on arsenic mobility in the groundwater system. Assisted in development of an aquifer material testing program to further elucidate the geochemical function of the aquifer and the implications for remediation of the site.*

\* denotes projects completed with other firms

## PUBLICATIONS

Finley, J.B. "Contaminant Transport Hazards During Flooding". In, E.E. Wohl, ed., *Flood Hazards in the Riparian Environment*. Cambridge University Press, 2000.

Finley, J.B., R.C. Ford, K. Behnke, J. Danni. "Management of Acid Drainage at Mining Facilities Using Dynamic Systems Modeling (DSM)". *Proceedings of the 4th International Conference on Acid Rock Drainage, Denver, CO, May 22 to May 24, 2000*.

Finley, J.B. and J.I. Drever. "Chemical Mass Balance and Rates of Mineral Weathering in High-Elevation Catchments". *Hydrological Processes*, vol. 11, pp. 745-764, 1997.

Finley, J.B., J.I. Drever, and J.T. Turk. "Sulfur Isotope Dynamics in a High-Elevation Catchment, West Glacier Lake, Wyoming". *Water, Air and Soil Pollution*, vol. 79, pp. 224-241, 1995.

Drever, J.I. and J.B. Finley. "Weathering and Pedogenesis at the Watershed Scale: High-Elevation Catchments in Silicate Terrains". *Chemical Geology*, vol. 107, pp. 289-292, 1993.

Mazor, E., J.I. Drever, J.B. Finley, P.W. Huntoon, and D.A. Lundy. "Hydrochemical Implications of Groundwater Mixing: An Example from the Southern Laramie Basin, Wyoming". *Water Resources Research*, vol. 29, pp. 193-205, 1993.

Finley, J.B. "Baseline Groundwater as a Foundation on which to Build a Successful Permitting Action". *American Exploration & Mining Association, Annual Meeting, Reno, Nevada, 2016*.

Finley, J.B. "Managing pit lakes for closure". *Session in a MWH sponsored workshop, Mine Closure: Lessons Learned and Closure Concepts, Lima Peru, 2015*.

Finley, J.B. and K.J. Johnson. One Day Geochemistry Training Session. *Environmental Department of the Cerro Verde Mine, Arequipa Peru, 2015*.

Rathburn, S.L., J.B. Finley, S.M. Klein, and Whitman, B.R. "Assessing Reservoir Sedimentation Using Bathymetric Comparison and Sediment Loading Measurements". *Geol. Soc. Am., Abstracts with Programs*, Vol. 36, No. 5. October, 2004.

Rathburn, S.L., J.B. Finley, S.M. Klein, and S.R. Smith. "A Sediment Budget for a Semi-Arid Reservoir: Preliminary Results". *American Geophysical Union Fall Meeting, San Francisco, CA. December 5-11, 2002*.

Finley, J.B., W.L. Niccoli, and R.C. Ford. "Application of Dynamic Systems Modeling to Integrate Hydrologic Processes in Mine Settings". *2002 Society of Mining and Metallurgical Engineers Annual Meeting, Phoenix, AZ, March 25 - 27, 2002*.

Finley, J.B., L.E. Eary, M. Shields, D.D. Runnells. "Dynamic Systems Modeling: A Method for Extending the Modeling of Pit-Lake Hydrology and Geochemistry". *Workshop on the Characterization, Modeling, Remediation, and Monitoring of Pit Lakes, Sponsored by the U.S. Environmental Protection Agency, Reno, NV, April 4 - 6, 2000*.

Finley, J.B. and W. Niccoli. Short course entitled, "Mine Closure Design - Mine Pit Lakes/Groundwater & Surface Water Baseline Data". *Presented at the Mine Design, Operations & Closure Conference, April. Polson, MT, 1999*.

## Jim B. Finley Ph.D., PG

Principal Geochemist

---

Finley, J.B., M. Shields, and D.D. Runnells. "Managing Water Quantity and Quality Using Dynamic Systems Modeling". *Presented at the Mine Design, Operations & Closure Conference, April, Polson, MT, 1999.*

Finley, J.B. and D.D. Runnells. "Managing Arsenic and Selenium in Mining Operations". *Presented at the 1st Annual Workshop on Heavy Metal Contaminants in Water, U.S. EPA, U.S. DOE, U.S. Army Corps of Engineers, and MSE Inc., Butte, MT, 1998.*

Finley, J.B., M. Shields, and D.D. Runnells. "Application of Dynamic System Modeling: A Simulation Tool for Water Management for the Mining Industry". *Presented at the Annual Environmental Managers Meeting, Kinross Gold, USA, Fairbanks, Alaska, 1998.*

Finley, J.B., D.D. Runnells, and R.C. Laird. "Seasonal Recharge and Manganese Concentrations in an Alluvial Aquifer, Platoro, Colorado". *American Water Resources Association—Colorado Section, Annual Meeting, Denver, Colorado, 1998.*

Shields, M., J.B. Finley, and D.D. Runnells. "Water and Chemical Mass Balance Modeling at Mine Sites: A Dynamic System Approach". *American Water Resources Association—Colorado Section, Annual Meeting, Denver, Colorado, 1998.*

Finley, J.B., D.D. Runnells, and J.F. Callender. "Isotope Geochemistry of a Low pH, Metal-Bearing Ground Water Plume, Southwest Jordan Valley, Utah". *Geol. Soc. Am. Abstracts with Programs, Vol. 29, 1997.*

Hall, D.J., J.W. Birkinshaw, C.R. Stevens, J.F. Callender, J.R. Bowman, D.K. Solomon, and J.B. Finley. "Investigation of Flow and Transport Model Parameters at the Bingham Canyon Mine, Southwest Jordan Valley, Utah". *Geol. Soc. Am. Abstracts with Programs, Vol. 29, 1997.*

Jett, S.M. and J.B. Finley. "Inorganic Phosphate Cycling in a Eutrophic, Warm-Water Lake". *EOS, Trans. Am. Geoph. Union, vol. 77, 1996.*

Finley, J.B. and D.K. Nordstrom. "Evaluation of the Chemical Model in WATEQ4F: 1. The Major Ion Activity Coefficients—Na, K, Ca, Mg, Cl". *Mineral. Mag. vol. 58A, p. 270-271, 1994.*

Finley, J.B., J.M. Beiswenger, and J.I. Drever. "Palynologic, Sedimentologic, and Geochemical Evidence of Environmental Conditions During Recent Deglaciation, West Glacier Lake, Snowy Range, Wyoming". *Geol. Soc. Am. Abstracts with Programs Vol. 26, pp. A62, 1994.*

Finley, J.B., J.I. Drever, and C.D. Frost. "Eolian Flux to an Alpine Catchment, Snowy Range, Wyoming". *Geol. Soc. Am. Abstracts with Programs, Vol. 25, pp. A318, 1993.*

Finley, J.B., J.I. Drever, and J.T. Turk. "Sulfur Isotope Dynamics In a High-Elevation Catchment, West Glacier Lake, Wyoming". *2nd Int. BioGEOMon, Abstract, Prague, Czech Republic, September, 1993.*

Finley, J.B. and J.I. Drever. "Seasonal Variations of Geochemical Processes in an Alpine Catchment, Snowy Range, Wyoming." *EOS, Trans. Am. Geoph. Union vol. 73, pp. 178, 1992.*

Jim B. Finley Ph.D., PG

Principal Geochemist

---

Finley, J.B. and J.I. Drever. "Solute Budgets in an Alpine Catchment: A Process-Level Investigation.". *EOS, Trans. Am. Geoph. Union, vol. 72, pp. 204, 1991.*

Finley, J.B. and J.I. Drever. "Sulfur Sources in the Glacier Lakes Catchment, Snowy Range, Wyoming.". *2nd Int. Symp. Environ. Geochem., Abstract, Uppsala, Sweden, September, 1991.*



STATE OF MAINE  
DEPARTMENT OF AGRICULTURE, CONSERVATION & FORESTRY  
LAND USE PLANNING COMMISSION

IN THE MATTER OF	)	Pre-Filed Direct Testimony of
REZONING PETITION ZP 779A	)	Lisa Turner, P.E., L.S.S. on Behalf
WOLFDEN MT. CHASE, LLC	)	of Wolfden Mt. Chase, LLC

On behalf of Wolfden Mt. Chase, LLC (“Wolfden”), Lisa Turner is submitting this pre-filed direct testimony in support of ZP 779A.

**I. QUALIFICATIONS AND EXPERIENCE**

Sevee & Maher Engineers, Inc. (SME) has been in business for 38 years, working on hydrogeologic and environmental engineering projects throughout the country. I am a Maine Professional Engineer and Licensed Soil Scientist. My primary practice has been hydrogeology and landfill design. In addition, my family had a large commercial vegetable farm for 25 years, which gave me extensive experience with various types of irrigation equipment.

In addition to myself, SME founders Peter Maher, P.E. and John Sevee, P.E., L.G. and SME president Erik Clapp, Ph.D., L.G., worked on this project.

My curriculum vitae is attached as Exhibit A.

**II. INVOLVEMENT WITH THE PICKETT MOUNTAIN PROJECT**

SME was retained by Wolfden to evaluate alternative methods for returning treated surface and mine water back to the environment. As discussed in the expert reports and pre-filed testimony of WSP and Mine Water Services (MWS), any surface water that may contact mined material will be collected and, along with water from mine dewatering, will be treated to appropriate background water quality standards. SME’s work focused on the reintroduction of this treated water back to the environment. We prepared two key reports: Water Management at

the Pickett Mountain Mine Site dated December 19, 2022 (included as Attachment 10-E in the initial application and as Exhibit B herein); and a response to staff comments dated April 12, 2023 (included herein as Exhibit C).

### **III. WATER MANAGEMENT OBJECTIVES**

The key objective of the water management system is to reintroduce the treated water to the site in a way that best maintains the existing hydrology of the surrounding wetlands. As described in the expert testimony submitted by WSP and MWS, any surface water that comes in contact with mining activities and all mine water will be treated using reverse osmosis technology to ensure it meets background water quality prior to its reintroduction to the site. In addition to evaluating various technologies for returning treated water back to the site, we also selected the appropriate location for disposition of treated water to maintain the current hydrology for each watershed as it recharges each of the site's wetland areas.

### **IV. WATER MANAGEMENT ALTERNATIVES**

There are four established disposition methods that were evaluated for the project: drip irrigation; infiltration galleries; spray irrigation; and snowmaking. Each is described below.

OPTION 1: DRIP IRRIGATION – Drip irrigation requires burying numerous pipes underground and allowing the water to infiltrate into the soil, similar to some agricultural applications such as is used in strawberry production. It is not commonly used in New England for year-round water disposition, and as such is not a proven technology for this location. Since a large number of buried pipes would be required, there would be a significant amount of soil disturbance for installation which may decrease infiltration, as well as more disturbance of the natural vegetation causing additional change in the natural character of the site. The piping must remain above the water table and be kept from freezing, which would require substantial build-

up with cover material. For these reasons, we concluded it was not an appropriate method to use at Pickett Mountain.

OPTION 2: INFILTRATION GALLERIES – Infiltration galleries are similar to a domestic leachfields, and generally include numerous chambers buried under a large land area. They are used extensively and successfully in Maine, and they have the benefit of requiring less land area than other alternatives and allow for year-round water disposition. Due to the dense soils at the site and large volume of water to be managed, a very large system would be required. Similar to a drip irrigation system, infiltration galleries will require a substantial disturbance of the natural vegetation and soils at the site, and require a build-up of soil on top of the chambers to prevent freezing. Typical wastewater has some biological activity that heats the water somewhat, but the reverse osmosis-treated water at Pickett Mountain will not have any of the biological activity. Therefore, for both drip irrigation and infiltration galleries, a greater thickness of soil cover will need to be added for freeze protection than that needed for a typical wastewater leachfield system. Removal of the system at the end of the project, as required by LUPC rules, will entail additional disturbance of soil and vegetation at that time.

Infiltration galleries were originally evaluated but for the reasons described below, a combination of spray irrigation and snowmaking is the preferred alternative. Infiltration galleries remain a viable back-up option, and would require additional field investigations to properly site and size such systems.

OPTION 3 SPRAY IRRIGATION – Spray irrigation includes pumping water through piping to spray nozzles that distribute the treated water to the site. Photographs of typical spray irrigation systems are included as Exhibit D. Spray irrigation is a proven technology for wastewater disposal in New England, and is currently used by several municipalities in Maine to

dispose of large volumes of treated wastewater. Spray irrigation allows for evaporation, transpiration, and infiltration. It can be easily installed without significant soil disturbance or tree clearing and provides a flexible distribution system for treated water. These systems can only be used in spring, summer, and early fall due to the freezing that occurs in colder months. These systems require a relatively large land area and active management.

OPTION 4 SNOWMAKING – Snowmaking is another proven technology for wastewater disposal in New England and, like spray irrigation, is currently in use by several municipalities in Maine. Snowmaking equipment for water disposition is the same as that used at ski resorts, and requires a similar installation of piping and equipment. Photos of snowmaking equipment are included as Exhibit E. Snowmaking is often used to manage water during the winter months at sites that use spray irrigation to dispose of treated wastewater during the warmer months. Like spray irrigation, it is a flexible technology for disposition of treated water and requires minimal soil disturbance or clearing of trees. It is available only during colder months and, like spray irrigation, requires active management. The acreage requirement for snowmaking is in addition to the land area required for spray irrigation because the snow will take time to melt in the spring.

## **V. PROPOSED WATER MANAGEMENT METHOD**

Based on our evaluation of the alternatives, it was determined that a combination of spray irrigation and snowmaking is the best method for managing treated water disposition at Pickett Mountain. These are proven technologies that are being used successfully to manage large volumes of water at municipal sites in Maine, including several spray irrigation systems with flows ranging from 74 to over 230 million gallons per year (MGY) sprayed on areas ranging from 36 to 113 acres. Likewise, several snowmaking systems are permitted in Maine and

currently dispose of 29 to 104 MGY using areas from 26 to 113 acres. Dave Roque, retired State Soil Scientist and LUPC third party reviewer, strongly encourages the use of spray irrigation and snowmaking as an alternative to infiltration galleries and SME concurs with his conclusion. As he noted, use of spray irrigation allows soils to remain relatively undisturbed, leaving the existing vegetation, an organic duff layer, and good soil structure.

It is expected that the Pickett project will require the disposition of 43.8 MGY of treated water, which is well within the range of other operating systems in Maine. In our April 2023 Response to LUPC comments (Exhibit C), SME evaluated each wetland catchment to determine the area that could be used for recharge. A total of 57 acres were delineated for spray irrigation, with spray rates ranging from 0.3 to 2.3 inches per week, which is less than the 3 to 4 inches per week used at other wastewater spray irrigation sites in Maine. The low spray rate means that there is excess capacity in the available recharge area, which will provide additional capacity and flexibility to accommodate any unforeseen changes in the estimated volumes of treated water to be managed, and will allow water to be directed to the most appropriate locations to maintain the hydrology of the surrounding wetlands.

Figure 3 in Exhibit C shows these potential recharge areas at the site, as well as the snow storage areas. The snow will be sprayed into piles at the upper elevations of three of the affected watersheds, so that the treated water will be able to infiltrate into the wetland watershed as the snow melts in the spring.

As an example, the Carrabassett Valley Sanitary District has been successfully using spray irrigation and snowmaking to dispose of their treated sanitary wastewater for nearly 30 years. Currently, Carrabassett Valley is permitted for 54 MGY, nearly four times as much as



proposed at Pickett Mountain. The Carrabassett Valley system, like Pickett Mountain, is located in an area with Class AA streams, trout fisheries, and relatively undisturbed wilderness.

## **VI. PROTECTION OF WETLAND AND STREAM HYDROLOGY**

We understand that the on-site wetlands must be maintained in their natural condition throughout the mine development period, as well as the post-closure period. Maintaining the current condition of each wetland requires estimating the current precipitation recharge and matching that amount. To do this, SME determined the current area of the watershed that recharges each wetland based on the available topographic mapping of the site. We then calculated a volume of water in each watershed, based on published annual precipitation data. Using the proposed site plan prepared by WSP, SME determined the area of recharge available to each wetland during the active period of mine development and determined the difference in precipitation recharge between the existing conditions and the active phase to determine the area of recharge lost to each watershed, and therefore the quantity of recharge to be replaced.

SME then added the total values for affected stormwater runoff and mine water as provided by WSP. It was assumed that snowmaking would occur for about one third of the year, and spray irrigation for approximately two thirds of the year. Due to the additional difficulty inherent in handling water during the winter months, snow stockpile areas were located in three of the wetland catchment areas closest to the ponds to minimize the risk of freezing of the water lines. Next, evaporative losses from the spray irrigation were calculated, which slightly reduced the total volume of water to be managed. The remaining volume to be sprayed was apportioned to each wetland watershed, based on the calculation of recharge to be replaced in a given watershed.

Maintaining a consistent recharge to wetland areas is a condition unique to this project and has not been required of municipalities that dispose of their treated wastewater through spray irrigation and/or snowmaking. As a result, the system proposed here is designed to achieve greater environmental protection than the systems in use elsewhere in the State.

The current design for disposition of water is a conceptual design. Additional field work will be required to complete the design, including accurate topographic mapping to better define the wetland watersheds, verification of the available soil mapping, and the installation of soil borings and piezometers to determine the depth to seasonal high-water table. Final design will incorporate these criteria, and include a final layout of piping as well as engineering calculations to determine the correct size for all pumps, pipes, sprinkler heads, and snow making equipment to ensure that the system functions correctly.

We appreciate the opportunity to provide this information to the LUPC and answer questions from the Commission, staff, and parties at the public hearing.

Dated: 9/18/23

*Lisa Turner*

Lisa Turner, P.E., L.S.S.

State of Maine, County of  
Cumberland

Date: 9/18/2023

Personally appeared before me the above-named Lisa Turner, who, being duly sworn, did testify that the foregoing testimony was true and correct to the best of her knowledge and belief.



Before me,

*Megan Johndro*

Notary Public

My commission expires: 06-22-2028

# **EXHIBIT A**

**LISA L. TURNER, P.E., L.S.S.**

EDUCATION

University of Maine – B.S. in Civil Engineering, with highest distinction, 1984  
University of Maine – B.S. in Soil Science, with highest distinction, 1984

PROFESSIONAL REGISTRATIONS AND CERTIFICATIONS

Professional Engineer – Maine  
Licensed Soil Scientist – Maine

EMPLOYMENT HISTORY

2021 to present – Sevee & Maher Engineers, Inc., Cumberland, Maine, Project Manager/ Senior Project Engineer  
2016 to 2017 – Sevee & Maher Engineers, Inc., Cumberland, Maine, Project Manager/Environmental Engineer  
1997 to 2021 – Laughing Stock Farm, Freeport, Maine, Owner/Manager  
1986 to 1992 – Sevee & Maher Engineers, Inc., Cumberland, Maine, Hydrogeologist/Project Engineer  
1984 to 1986 – E.C. Jordan, Portland, Maine, Project Engineer  
1981 to 1982 – Univ. of Maine Plant and Soil Department, Orono, Maine, Soil Laboratory Technician

AFFILIATIONS

Maine Vegetable and Small Fruit Growers Association (MVSFGA) – member; past president and board member  
Maine Organic Farmers and Gardeners Association (MOFGA) – past president and board member  
Greater Freeport Chamber of Commerce – past treasurer and board member

APPOINTMENTS

Land for Maine’s Future Board – 2016 to 2021

AWARDS

Commissioner’s Distinguished Service Award, 2014 – Maine Department of Agriculture, Conservation, and Forestry

PROFESSIONAL EXPERIENCE

Ms. Turner has been involved in solid and hazardous waste site feasibility studies, landfill design, monitoring, and hydrogeologic computer modeling. She has conducted exploratory field investigations to evaluate site suitability for acceptance of wastes; used computer groundwater models to evaluate groundwater and chemical transport; prepared waste management designs at feasibility and final design level; and monitored landfill construction. Projects she has been involved in have required coordination with: test boring and test pitting contractors, surveyors, site evaluators, geologists, chemical engineers, hydrogeologists, and general contractors.



Typical assignments in her various areas of expertise include:

#### Solid Waste/Landfill

- Prepared landfill designs for solid waste landfills including landfill base grades, liner systems, operating plans, access roads, surface water drainage, leachate generation estimates, leachate collection systems, pump sizing, leachate pond sizing, erosion control calculations, detention ponds, closure caps, and cost estimates.
- Monitored test pitting and drilling on numerous sites in support of landfill development, subdivision development, and geotechnical investigations;
- Prepared computer groundwater model to predict possible failure scenarios for a proposed paper mill landfill;
- Performed Hydrologic Evaluation of Landfill Performance (HELP) model calculations for numerous landfills;
- Interpreted geologic data including test pit logs, boring logs, and seismic logs to prepare geologic profiles for numerous sites;
- Performed site searches for new paper mill landfills, including evaluating soil surveys, geologic maps, seismic maps, and sand and gravel aquifer maps; review of state regulatory requirements, and site reconnaissance to locate potential sites with suitable characteristics; monitored test pitting and drilling to evaluate new sites;
- Performed construction monitoring for conventional and secure landfills in central Maine. Responsibilities included daily inspections of construction contractor to ensure that construction progress followed plans and specifications, review clay and synthetic liner testing data, and review of payment quantities and budgets;
- Designed demolition debris transfer station including access road, retaining wall, and interim waste storage bin;
- Reviewed water quality data for annual reporting for numerous sites and made recommendations for monitoring programs; and
- Performed hydrogeologic evaluations, including review and analysis of data and incorporation of various numerical and analytical computer groundwater models.

#### Site Development

- Prepared Maine Department of Environmental Protection permit applications for sand and gravel and clay borrow pits;
- Prepared a Natural Resource Protection Act (NRPA) permit for coastal development;
- Performed soil mapping for selection of appropriate sites for land application of industrial wastes, residential development, gravel pit permitting, and wetlands;
- Performed analysis of soil stability and settlement for foundations for oil storage tank, access road, and group residential building ;
- Prepared groundwater models to predict nitrogen pathways from septic systems in numerous large subdivisions to evaluate safety of potable water both on and off site; and
- Prepared grading plan and drainage for 75' by 96' gutter-connect greenhouse.

### Site Evaluation and Remediation

- Prepared 2.5D computer groundwater model of a 2.5 square mile area to characterize and predict flows of groundwater and contaminants for an old landfill under consent decree with U.S. Environmental Protection Agency;
- Managed evaluation and cost estimate for remediation of asbestos at a paper mill;
- Performed Phase I Environmental Site Assessment; and
- Studied the statistical correlation between the properties of organic chemicals and their affinities for various soils, based on measurable soil characteristics.

### Research

- Performed chemical and physical analyses to assist in Soil Conservation Service classification of the soils of Maine; and
- Developed analytical method for estimating seepage through engineered RCRA Subtitle C surface impoundments for U.S. EPA.

## **EXHIBIT B**

## TECHNICAL MEMORANDUM

TO: Doug Stewart, Stantec

FROM: Peter Maher, P.E.  
Erik Clapp, L.G.  
Lisa Turner, P.E., L.S.S.

DATE: December 19, 2022

SUBJECT: **WATER MANAGEMENT AT THE PICKETT MOUNTAIN MINE SITE**

### **1.0 PURPOSE AND BACKGROUND**

Wolfden Mt. Chase LLC (Wolfden) is proposing to mine zinc, lead, copper, silver, and gold from a metallic mineral deposit located in T6R6 in Penobscot County, Maine, named the Pickett Project. The land where the mine will be located is in the General Management (M-GN) Subdistrict and needs to be rezoned to the D-PD Subdistrict, to allow for a well-planned mining development. Mining is regulated under LUPC Chapters 10, 12, and 13 Rules. If rezoning is approved, mining operations must also satisfy Maine Department of Environmental Protection (MEDEP) Chapter 200 Metallic Mineral Exploration, Advanced Exploration and Mining Rules, and receive a mining permit. The information contained herein is being prepared in support of the LUPC rezoning from M-GN to D-PD Subdistrict.

The Project is proposed as a “mine only” operation which will limit the volume of water from precipitation events that will require treatment. Any surface water that may contact mine materials will be collected and, along with water from mine dewatering, will be treated to appropriate water quality standards and returned to the on-site environment. Sevee & Maher Engineers, Inc. (SME) was tasked by Stantec to review available information and develop conceptual methods for returning treated water back to the on-site environment.

### **2.0 BACKGROUND DOCUMENTS REVIEWED**

Several documents were made available to SME to assist in our evaluation of water treatment alternatives for the Pickett Mountain site. These documents include:

- Conceptual Site Plan (prepared by WSP, dated October 17, 2022)
- Soil Suitability Map 2 (prepared by Wood dated September 28, 2022)
- Mine Water Treatment Scoping Study (prepared by Mine Water Service dated September 11, 2022)
- Technical Memorandum re: Precipitation Runoff Collection Areas (prepared by Wood, dated August 25, 2022)

- Soil Suitability Evaluation (prepared by WSP and Watershed Resource Consultants, dated September 2022)

### **3.0 WATER MANAGEMENT ALTERNATIVES ANALYSIS**

Wolfden is proposing to rezone 374 acres (WSP, September 2022) to accommodate the mining project. Within the 374-acre area, there will be approximately 28.39 acres where materials will be stored and contact water will be generated from precipitation events. Approximately 28 million gallons per year (MGY) of water will be collected from within these 28.39 acres. Additionally, the mine will be dewatered to facilitate operations. The mine dewatering will generate an additional 15.8 MGY (about 30 gallons per minute [gpm]) of water, for a total of 43.8 MGY to be collected, treated, and re-introduced to the watershed (Wood, August 25, 2022). An on-site collected water treatment facility, which will use ultrafiltration and reverse osmosis technologies, will treat the 43.8 MGY of collected runoff and groundwater to applicable water quality standards (Mine Water Services, September 11, 2022). The objective of SME's efforts is to identify viable alternatives for the on-site disposition of this treated water.

Four water disposition methods were identified and evaluated by SME:

- Drip irrigation;
- Infiltration galleries;
- Spray irrigation; and
- Snowmaking.

Major considerations used to evaluate each of the treatment alternatives included the on-site soil and geologic characteristics (including soil permeability, depth to bedrock, depth to water table, and slopes), available suitable land within the 374 acres proposed for rezoning, maintaining the existing hydroperiod for on-site wetlands, and climate considerations (summer and winter disposition).

#### **3.1 Drip Irrigation**

While drip irrigation would be "out of the way" once installed, it had several disadvantages identified during our study, making it the least attractive of the alternatives identified for this site for the following reasons:

- Requires large acreage;
- Not commonly used in New England (not a proven technology in our area);
- Requires substantial cover material build-up and continuous flows to avoid freeze-ups in the winter due to a lack of biological activity in the disposition water;
- Requires burial and therefore substantial soil disturbance for installation; and
- Installation is intended for flat fields and not a wooded environment.



### 3.2 Infiltration Galleries

Infiltration galleries are similar to a subsurface wastewater disposal system. They are used extensively throughout New England to dispose of municipal, industrial, and residential wastewater. There are several large systems (11 to 26 MGY) located in the state of Maine which have been operating successfully for as long as 30 years and is a proven wastewater disposal technology. The advantages of infiltration galleries are that they have the potential to be a year-round disposition option if constructed with adequate cover, use less land area than the other alternatives evaluated, and are “out of the way” once constructed. Disadvantages of infiltration galleries include:

- Expensive to construct;
- Require suitable soils, and soils at this site may be too fine-grained to accept the infiltration rates expected for this project without constructing a very large system;
- Installation will require soil disturbance (i.e., potential compaction and smearing) of existing soils and organic layers, potentially reducing the infiltration capacity;
- A substantial amount of cover material build-up would be required to avoid freeze-ups in the winter due to a lack of biological activity in the disposition water; and
- Galleries will need to be removed at the end of the project.

### 3.3 Spray Irrigation

Spray irrigation is a proven technology for wastewater disposal in New England. It allows for evaporation, transpiration, and infiltration. It is easily installed without significant soil disturbance or clearing of trees and provides flexible distribution of the treated water. Spray irrigation will facilitate the evaporation of some of the disposition water, which will allow for the best match of pre- and post-development water infiltration at the site. A number of spray irrigation systems are permitted and successfully operated in northern New England with flows ranging from 74 to over 230 MGY sprayed on 36 to 113 acres. The disadvantages of spray irrigation are that it:

- Can only be used in the late spring, summer, and early fall;
- Requires active management; and
- Requires sufficient acreage.

### 3.4 Snowmaking

Snowmaking is also a proven technology for wastewater disposal in New England. It is often combined with spray irrigation to minimize the storage requirement for treated water during the winter months. Similar to spray irrigation, snowmaking is a flexible technology for the disposition of treated water. Also, similar to spray irrigation, a number of systems are permitted in New England, successfully disposing of 29 to 104 MGY applied to 26 to 113 acres. Snowmaking is a proven technology for wastewater disposition, is easily installed without significant soil disturbance or clearing of trees, and dovetails well

with spray irrigation, thereby reducing storage requirements for treated water. Disadvantages of snowmaking include:

- Only an option during late fall, winter, and early spring;
- Requires active management;
- Potential for freeze-ups during winter operations; and
- Has an acreage requirement that is separate from the acreage for spray irrigation.

### 3.5 Spray Irrigation/Snowmaking Combination

There are numerous combination Spray Irrigation/Snowmaking systems in operation in New England. These systems are typically in locations where there is no opportunity to discharge treated wastewater to a surface water. Examples of these systems operating in Maine include:

Moosehead System. This facility has been in operation for over 40 years and treats 206 MGY. The spray irrigation portion of the system uses an application rate of 2.5 inches/week and the snowmaking system uses an application rate of 4.1 inches/week. Approximately 89 acres of glacial till soils are used for this system.

Carrabassett Valley System. The Carrabassett Valley System treats a total of 183 MGY. The spray irrigation portion applies 3.7 inches/week over 129 acres and the snowmaking portion applies 2.9 inches/week over 54 acres. This site is located on approximately 75 acres of glacial till soils.

Rangeley System. This facility treats 103 MGY. The spray irrigation portion applies 2.5 inches/week over 36 acres and the snowmaking portion applies 1.6 inches/week over 28 acres. Similar to the Moosehead and Carrabassett Systems, it is located on glacial till soils not unlike those found at Pickett Mountain.

Wolfeboro, NH. This system treats 97 MGY of treated wastewater on 46 acres. The application rate is 3 inches/week. They do not use snowmaking, which requires them to have larger storage lagoons.

Pineland Farms Potatoes. This system is designed to treat 337 MGY of wastewater from a potato processing facility in Aroostook County. The spray irrigation portion applies 2 inches/week, and the snowmaking portion applies less than one inch/week over a total of 113 acres.

## **4.0 SELECTED ALTERNATIVE**

Based on our analyses of the four alternatives, a combination of spray irrigation and snowmaking, combined with water storage is the preferred alternative for the Project. Both are proven technologies for the disposition of treated wastewater in New England. It is expected that this combination of technologies will readily manage the disposition of the 43.8 MGY of treated water.

The spray irrigation/snowmaking alternative allows for the flexible disposition of treated water to maintain the hydroperiod of the nearby wetland. Furthermore, application rates can be tailored to mimic natural, long-term precipitation patterns.

The use of infiltration galleries is another alternative that could possibly be utilized; however, additional soils investigations will need to be conducted to determine if appropriate soils are present to handle the water generated. It may be possible to utilize this technology in combination with spray irrigation and snowmaking if areas with suitable soils are identified. If this alternative were to be utilized, it would require additional supporting information from a detailed soil investigation.

Figure 1 (attached) presents a site plan which shows potential Water Recharge Areas where treated water can be disposed. A total of 60 acres is available for use for water recharge. Based on application rates of 2 to 4 inches of water per week (typical of the systems described in Section 3.5), approximately 15 to 29 acres would be required for the Spray Irrigation/Snowmaking alternative. A 46-acre solar farm is proposed at the site and some of this land could also be utilized for treated water disposition.

## **5.0 SUMMARY AND RECOMMENDATIONS**

The combination of pre-treatment and post-treatment water storage, coupled with spray irrigation and snowmaking, will adequately handle the disposition of treated water at the Project site. Using these technologies, and application rates typical of similar projects at similar sites, will require between 15 and 29 acres of land required for disposal. There are at least 60 acres of available land which could be utilized for treated water disposition within the 374 acres proposed for rezoning.

The selection and positioning of land areas selected for treated water disposition can be determined once detailed soil studies and site topography have been completed. It will be critical to understand the hydrology of the on-site wetlands so that the pre-development water balance of these features can be maintained.

### Attachment

- Figure 1 – Potential Collected Water Recharge Areas

I:\SERVER\cfs\Stantec\Pickett\_MLACAD\Plans\SP05 PM Drawing 2022R10.dwg, WDA FIG 1, 12/19/2022, 3:23:05 PM, jrl

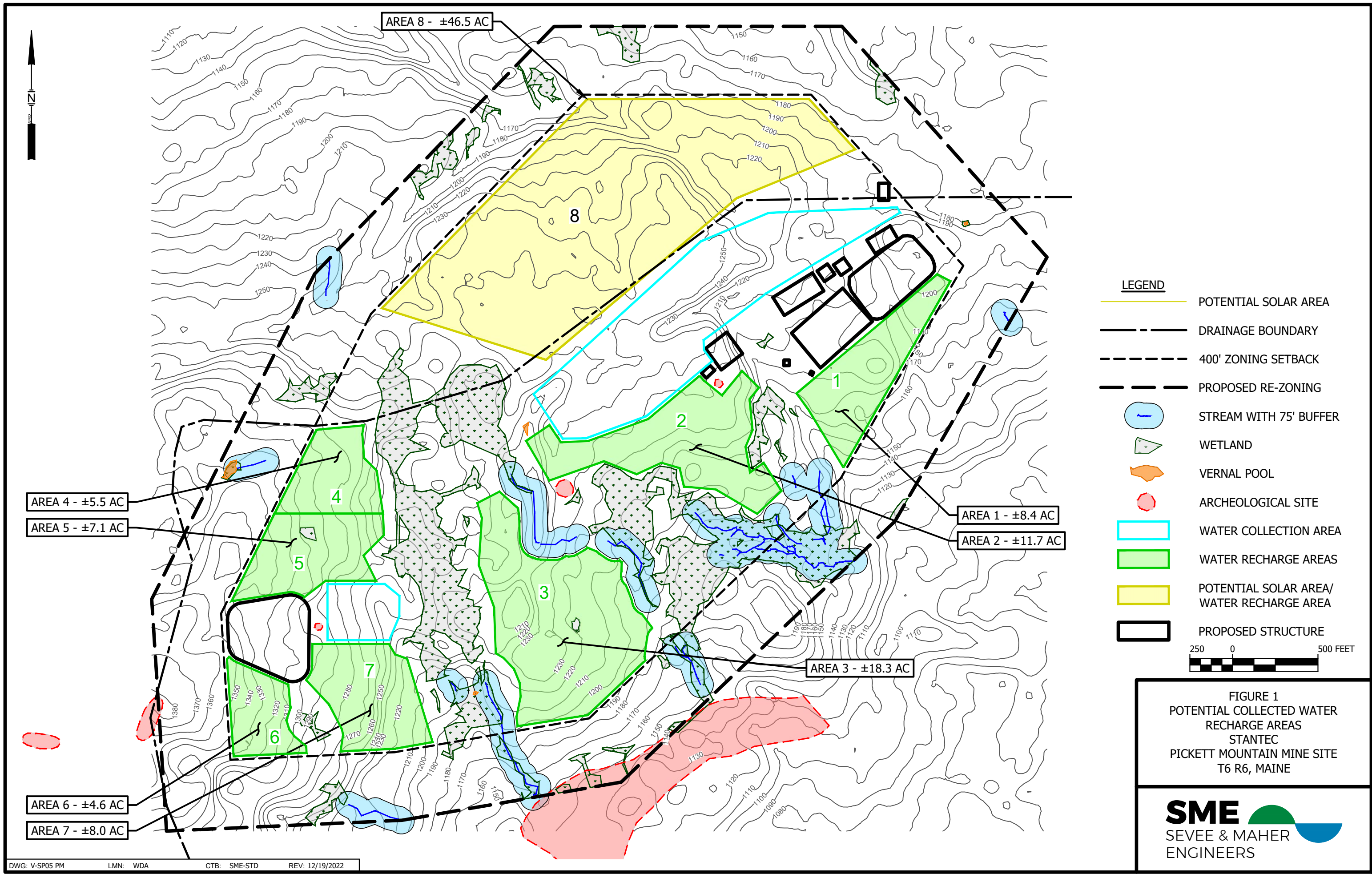

FIGURE 1  
 POTENTIAL COLLECTED WATER  
 RECHARGE AREAS  
 STANTEC  
 PICKETT MOUNTAIN MINE SITE  
 T6 R6, MAINE



# **EXHIBIT C**



## TECHNICAL MEMORANDUM

TO: Jeremy Ouellette, Wolfden Resources Corporation

FROM: Peter Maher, P.E.  
Erik Clapp, L.G.  
Lisa Turner, P.E., L.S.S.

DATE: April 12, 2023

SUBJECT: **WATER RESOURCE PRESERVATION AT THE PICKETT MOUNTAIN MINE SITE**

### LUPC COMMENT 11 - STORMWATER AND MINE WATER MANAGEMENT

The application does not include a sufficient demonstration that the discharge of collected storm and mine waters would have no undue adverse impact on downgradient wetland and stream hydrology, especially considering the timing and quantity of water flows. If any wetland or flowing water will receive more or less water than pre-development, provide evidence to demonstrate that there will not be undue adverse impacts on those habitats or the species depending on those habitats. Consider if water would be diverted from one subcatchment area to another and that water from mine shaft dewatering may not have reached the streams pre-development and therefore will be a source of additional volume.

#### SME's Response:

#### Hydrogeologic Overview of the Site's Water Resources

The Pickett Mountain site is located on the crest of a hill; therefore, it is assumed that there is no discharge of deep groundwater to the site's surface water. The only recharge to the ground and surface water system at the site is from precipitation. A portion of the precipitation will be lost to evapotranspiration, a portion will infiltrate through the overburden to the bedrock groundwater system, and the remainder will either infiltrate into the shallow overburden groundwater or run off to downgradient areas.

Given the sloping topography of the site and the generally low permeability of bedrock in the area, it is anticipated that as the shallow groundwater reaches the wetlands at the toe of the slope, it will discharge and, along with the site's runoff, recharge the wetlands. These wetlands subsequently discharge to the intermittent and perennial streams on-site and surrounding the site. In order to retain the character of the wetlands and streams, it will be necessary to maintain a similar amount of recharge to each wetland after mine development. Based on the analysis presented below, pre-development and post-development inflow to the site wetlands will vary by less than one percent.

### Precipitation Recharge to the Undeveloped Site

Sevee & Maher Engineers, Inc. (SME) used an average precipitation value of 45 inches per year (Wood, Technical Memorandum to Wolfden, revised August 25, 2022) to calculate a total average precipitation inflow of approximately 456 million gallons per year (MGY) for the 374-acre site. LIDAR topography was reviewed relative to the wetland areas on and immediately adjacent to the site, and seventeen separate wetland catchments were identified for the pre-development condition. These wetland catchments are depicted on Figure 1.

### Precipitation Recharge to the Developed Site

Three separate areas totaling approximately 31 acres will require collection of precipitation once the site is developed. These are shown as water collection areas on Figure 2 and include the following:

- 1R1 and 1R2 - the pre-treatment and post-treatment ponds,
- 1S - the main developed area in the center of the site, and
- 1T - Ore Storage Pad #2 and Waste Rock Pad #2.

The proposed development will occur in seven of the initial 17 wetland catchments (1E, 1F, 1G, 1H, 1N, 1O, and 1P) and will alter natural precipitation recharge in those areas. To estimate the recharge to each wetland catchment during the developed condition, the affected wetland catchments delineated in Figure 1 were reduced to reflect the removal of the water collection areas from the wetland catchments (see Figure 2).

A new, reduced value for total water inflow from precipitation was calculated for each of the seven affected catchments. In the pre-development condition, these catchments collectively receive approximately 347 MGY of inflow from precipitation. In the post-development condition, they will receive only 309 MGY of inflow from precipitation, a total reduction of inflow of 38 MGY or 11 percent of the initial inflow to the affected catchments.

### Quantity of Treated Water to be Introduced to the Developed Site

Based on the HydroCAD evaluation prepared by Wood (August 2022), of the estimated 38 MGY of precipitation falling on the water collection areas, only 28 MGY will be collected as surface water runoff. The remainder is an evaporative loss of 10 MGY, as calculated by the HydroCAD model, which is consistent with the average evapotranspiration values for the northeast (Hanson, R.L., 1991, Evapotranspiration and Droughts, in Paulson, R.W., Chase, E.B., Roberts, R.S., and Moody, D.W., Compilers, National Water Summary 1988-89--Hydrologic Events and Floods and Droughts: U.S. Geological Survey Water-Supply Paper 2375, p. 99-104). An additional 15.8 MGY of mine water (Wood, August 2022) will be treated and require disposition, for a total of 43.8 MGY to be reintroduced to the site's water recharge system.

Of this 43.8 MGY, approximately 11.8 MGY is planned to be distributed on the site as snow through the utilization of snow making equipment, with the remaining 32 MGY being distributed through spray irrigation. A sprinkler evaluation nomograph (Frost and Schwalen, 1955) and typical

atmospheric conditions at the site (based on climatic data for Patten, Maine on [weather-us.com/en/maine-usa/patten-climate](https://weather-us.com/en/maine-usa/patten-climate)) during the spray season (April through September) were used to determine that approximately 8.5 percent, or 2.7 MGY of the spray irrigation water will evaporate during spraying. This leaves 29.3 MGY of spray irrigation water along with the 11.8 MGY of snow that will be added back to the water recharge system, a total of 41.1 MGY.

#### Introduction of Treated Water to the Developed Site

38 MGY of the total 41.1 MGY of water to be introduced can be apportioned back to replace the water lost from the seven wetland catchments that were reduced in size by the development. This leaves a remaining 3.1 MGY of water that will need to be apportioned to the site. Because this is such a small percentage of the total inflow to the affected catchments (0.9 percent of the initial precipitation recharge of 347 MGY) and falls well within the natural variation at the site (see discussion below), it is not necessary to apportion the excess water over the entire site. The excess water can be distributed to the seven affected catchments within the natural variation of precipitation for the site and is not anticipated to have an adverse impact on the associated wetland and stream resources. A summary of the water inflows to each catchment for the pre-development and developed conditions is included in Table 1.

Potential areas were designated for the spray irrigation and snow stockpiles for treated water, as depicted on Figure 3. Final locations will be determined as part of the final design for the disposition of treated water.

TABLE 1

WETLAND CATCHMENT AREAS AND INFLOWS  
PRE- AND POST-DEVELOPMENT

Catchment ID	Contains Wetlands	Pre-Development Area (SF)	Developed Area (SF)	Decreased Inflow Post-Development (SF)	Pre-Development Precipitation (gal/yr)	Post-Development Precipitation (gal/yr)	Precipitation Deficit (gal/yr)	Total Post-Development Inflow Including Precipitation (gal/yr)	Additional Post-Development Flow to Catchment (gal/yr)
<b>CATCHMENTS REDUCED BY DEVELOPMENT</b>									
1E	Adjacent	687,000	430,000	-257,000	19,270,000	12,062,000	7,208,000	125,000	7,333,000
1F	Adjacent	492,000	472,000	-20,000	13,801,000	13,240,000	561,000	137,000	698,000
1G	No	786,000	449,000	-337,000	22,047,000	12,594,000	9,453,000	131,000	9,584,000
1H	Yes	2,439,000	2,413,000	-26,000	68,414,000	67,685,000	729,000	703,000	1,432,000
1N	Yes	3,284,000	3,152,000	-132,000	92,116,000	88,414,000	3,702,000	918,000	4,620,000
1O	Yes	1,041,000	948,000	-93,000	29,200,000	26,591,000	2,609,000	276,000	2,885,000
1P	Yes	3,656,000	3,171,000	-485,000	102,551,000	88,947,000	13,604,000	924,000	14,528,000
Total		12,385,000	11,035,000		347,399,000	309,533,000	37,866,000	3,214,000	41,080,000
Percent of Pre-Development Precipitation							10.9%	0.9%	11.8%
<b>CATCHMENTS UNAFFECTED BY DEVELOPMENT</b>									
1A	No	50,000	50,000	0	1,403,000	1,403,000	0	0	0
1B	Yes	192,000	192,000	0	5,386,000	5,386,000	0	0	0
1C	No	737,000	737,000	0	20,673,000	20,673,000	0	0	0
1D	Yes	422,000	422,000	0	11,809,000	11,809,000	0	0	0
1I	No	12,000	12,000	0	337,000	337,000	0	0	0
1J	Yes	370,000	370,000	0	10,379,000	10,379,000	0	0	0
1K	Yes	251,000	251,000	0	7,013,000	7,013,000	0	0	0
1L	No	670,000	670,000	0	18,794,000	18,794,000	0	0	0
1M	Yes	507,000	507,000	0	14,221,000	14,221,000	0	0	0
1Q	Yes	674,000	674,000	0	18,934,000	18,934,000	0	0	0
		3,884,000	3,884,000						
<b>DEVELOPED AREAS (ALL PRECIPITATION COLLECTED)</b>									
1R	Two Ponds		253,000						
1S	Development		966,000						
1T	Development		131,000						

The total number of inches per week of precipitation added to each snow stockpile from snowmaking was calculated and is included as Table 2. On average, assuming a 20-week-long snowmaking season, an equivalent of approximately 3.0 inches of precipitation per week will be added to wetland catchments 1E, 1G, and 1P, as shown in Table 2. This is below the up to four inches of weekly recharge typically seen at other wastewater snowmaking sites in Maine.

**TABLE 2**

**PROPOSED INCHES OF RECHARGE ADDED THROUGH SNOWMAKING**

Catchment ID	Total Proposed Length of Snow Pile (feet)	Total Precipitation Deposited per Catchment as Snowmaking (gal/yr of water)	Inches of Water Added per Week (inches)
1E	500	1,790,000	3.0
1G	1,090	3,903,000	3.0
1P	2,320	8,307,000	3.0
<b>TOTAL</b>	3,910	14,000,000	

The volume of precipitation added to each wetland catchment as snow was subtracted from the total amount of precipitation to be added to provide recharge to the catchment. The remaining quantity of additional water to be added to each affected wetland catchment through spray irrigation was divided by the square footage of the proposed spray irrigation areas and an assumed 20-week spray irrigation period. The weekly recharge rate ranges from a low of 0.3 inches per week in wetland catchment 1H to a high of 2.3 inches per week in wetland catchment 1E. This demonstrates that there is more than enough area in each affected wetland catchment to allow water to be added at rates below the up to four inches of recharge typically seen at other wastewater spray irrigation sites in Maine (see application Attachment 10-E) and provide sufficient water to recharge the wetlands. These recharge values are summarized in Table 3.

**TABLE 3**

**PROPOSED INCHES OF RECHARGE ADDED THROUGH SPRAY IRRIGATION**

Catchment ID	Additional Post - Development Flow to Catchment (gal/yr)	Total Snow Recharge Deposited per Catchment (gal/yr of water)	Remaining Flow to be Added to Catchment as Spray Irrigation (gal/yr)	Total Proposed Spray Recharge Area (square feet)	Inches of Water Added as Spray Irrigation per Week (inches)
1E	7,333,000	1,790,000	5,543,000	<b>191,800</b>	2.3
1F	698,000	0	698,000	<b>99,900</b>	0.6
1G	9,584,000	3,903,000	5,681,000	<b>267,700</b>	1.7
1H	1,432,000	0	1,432,000	<b>406,000</b>	0.3
1N	4,620,000	0	4,620,000	<b>590,900</b>	0.6
1O	2,885,000	0	2,885,000	<b>103,900</b>	2.2
1P	14,528,000	8,307,000	6,221,000	<b>836,100</b>	0.8
	41,080,000				



As can be seen on Figure 3, a portion of the spray irrigation areas in wetland catchments 1E, 1F, 1G, and 1P will be within the 400-foot setback from the edge of the rezoning area. No structures or clearing will be located in the setback, the usage is simply adding spray water recharge to maintain the wetland areas.

#### Variation in Naturally Occurring Precipitation

To assess the impact of an additional 0.9 percent of inflow to the wetlands, SME reviewed the historical precipitation data for Caribou, Maine, from 1939 to 2018 (National Oceanic and Atmospheric Administration), which is the nearest station to Patten with long-term data available. The data was averaged in ten-year increments, beginning in 1939. The lowest ten-year average was 34.8 inches from 1959 through 1968, the highest was 43.7 inches from 2009 to 2018, a 25 percent difference. The lowest individual precipitation year was 28.1 inches in 1987, the highest year was 55.4 inches in 2011, a 97 percent difference. Given the large variability in natural precipitation in the area, it is assumed that an additional 0.9 percent inflow to the wetlands will not cause an undue adverse impact on the water resources at the site. A graph of the eighty years of precipitation data showing the annual variability is included as Figure 4.

#### **LUPC COMMENT 4 - SPRAY IRRIGATION AND SNOWMAKING**

**Provide conceptual schematics for proposed spray irrigation and snowmaking equipment for the Water Recharge Areas (WRAs).**

SME's Response: Attachment 1 contains photos and schematics of typical spray irrigation equipment commonly used at wastewater treatment plants. Attachment 2 contains photos and schematics of typical snow making equipment commonly used at wastewater treatment plants, as well as some examples of snow stockpiles. Attachment 3 includes a case study of wastewater disposal through spray irrigation and snowmaking in Carrabassett, Maine.

Potential areas were designated for the spray irrigation and snow stockpiles of treated effluent, as depicted on Figure 3. Due to the inherent challenges in managing water during the winter at below freezing temperatures, the proposed snow stockpiles were selected to be near the storage ponds and to be at the highest points in the wetland catchments so that melting snow will drain to the wetland areas. Final locations will be determined as part of the final design for the disposition of treated water.

#### **LUPC COMMENT 6 – SNOW STORAGE IN AFFECTED AREA**

**Provide evidence that sufficient area is set aside for storing snow from the collection area.**

SME's Response: The following table provides an estimate of the annual snow storage requirement for the developed area. It is anticipated that only one third of the site will require snow removal, with the remainder of the developed portion of the site consisting of the treatment ponds, rock storage areas, etc. The required storage volume assumes a snow compaction rate of 70 percent, which is expected to occur during placement and settling. The 2.6-acre snow storage area shown on Figure 5 would require only a 16-foot-high snow pile, as calculated in Table 4. The average annual snowfall was taken from climate data for Caribou Municipal Airport, Maine as reported by the

National Oceanic and Atmospheric Administration (NOAA), National Snowfall Analysis. ([National Gridded Snowfall Analysis - NOHRSC - The ultimate source for snow information \(noaa.gov\)](https://www.noaa.gov/education/outreach-and-communication/national-snowfall-analysis))

**TABLE 4**

**DEVELOPED AREA SNOW STORAGE**

Annual Snow Fall	118	inches
Collection Footprint	1,350,000	SF
Percent of Footprint requiring snow removal	33%	
Volume of Snow to be Stockpiled	4,388,000	CF
Snow Compaction from Placement and Settling	70%	
Compacted Snow Volume Collected	1,316,000	CF
Proposed Snow Storage Footprint	2.6	acres
Required snow storage height	16	ft
<p><u>Abbreviations:</u> ft = feet SF = square feet CF = cubic feet</p>		

Attachments:

Figures 1 through 5



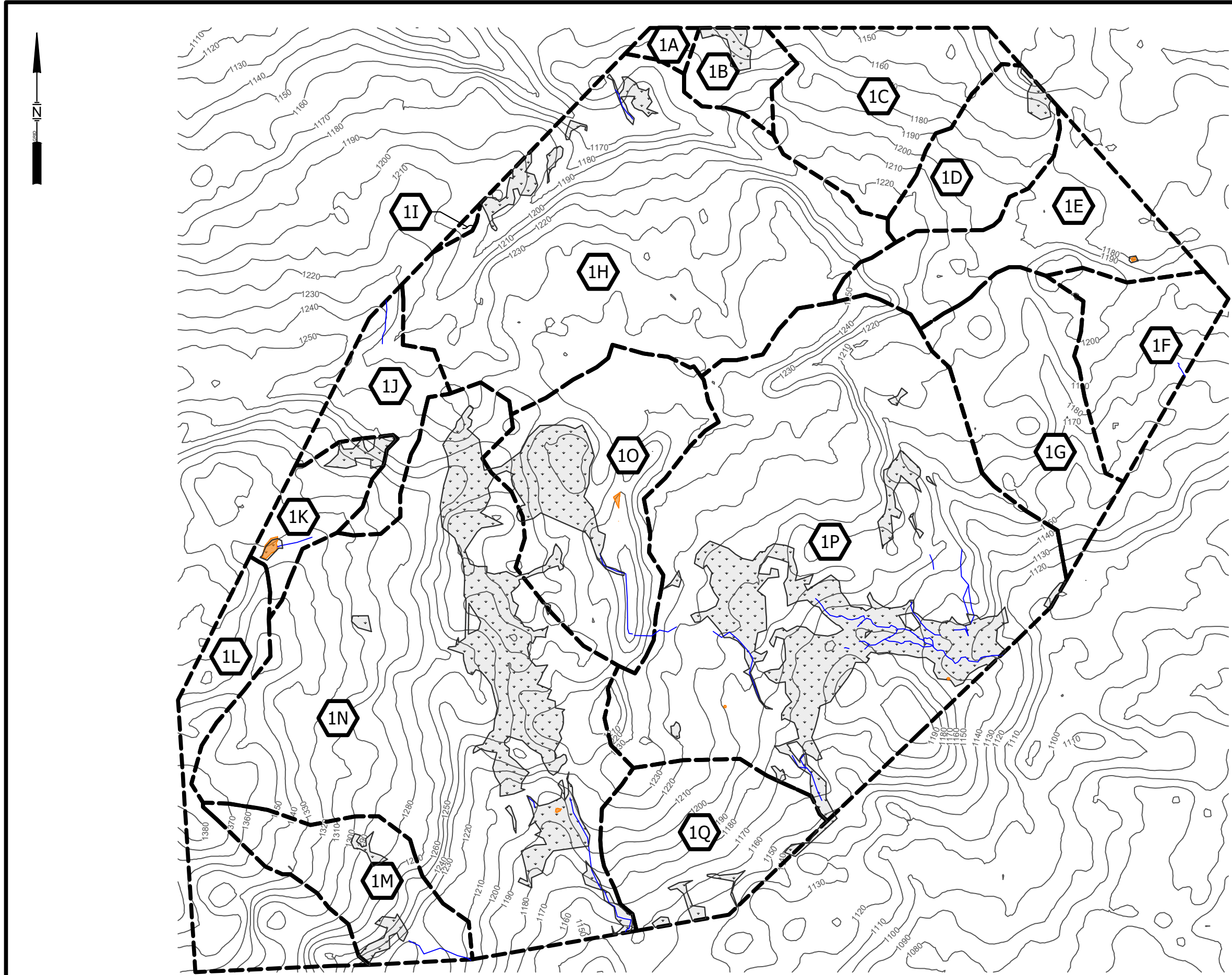

Attachment 1 Spray Irrigation Systems and Equipment

Attachment 2 Snowmaking Systems and Equipment

Attachment 3 Case Study: Carrabassett, Maine Wastewater Disposal through Spray Irrigation and Snowmaking



**LEGEND**

-  PRE-DEVELOPMENT WETLAND CATCHMENTS
-  CATCHMENT DESIGNATION
-  STREAM
-  WETLAND
-  VERNAL POOL



**FIGURE 1**  
**PRE-DEVELOPMENT**  
**WETLAND CATCHMENTS**  
**WOLF DEN RESOURCE CORPORATION**  
**PICKETT MOUNTAIN MINE SITE**  
**T6 R6, MAINE**





I:\SERVER\cts\Wolfden\ACAD\Plans\BASE.dwg, FIG 2 - SMP-POST-DEV, 3/21/2023 7:58:22 AM, jrl

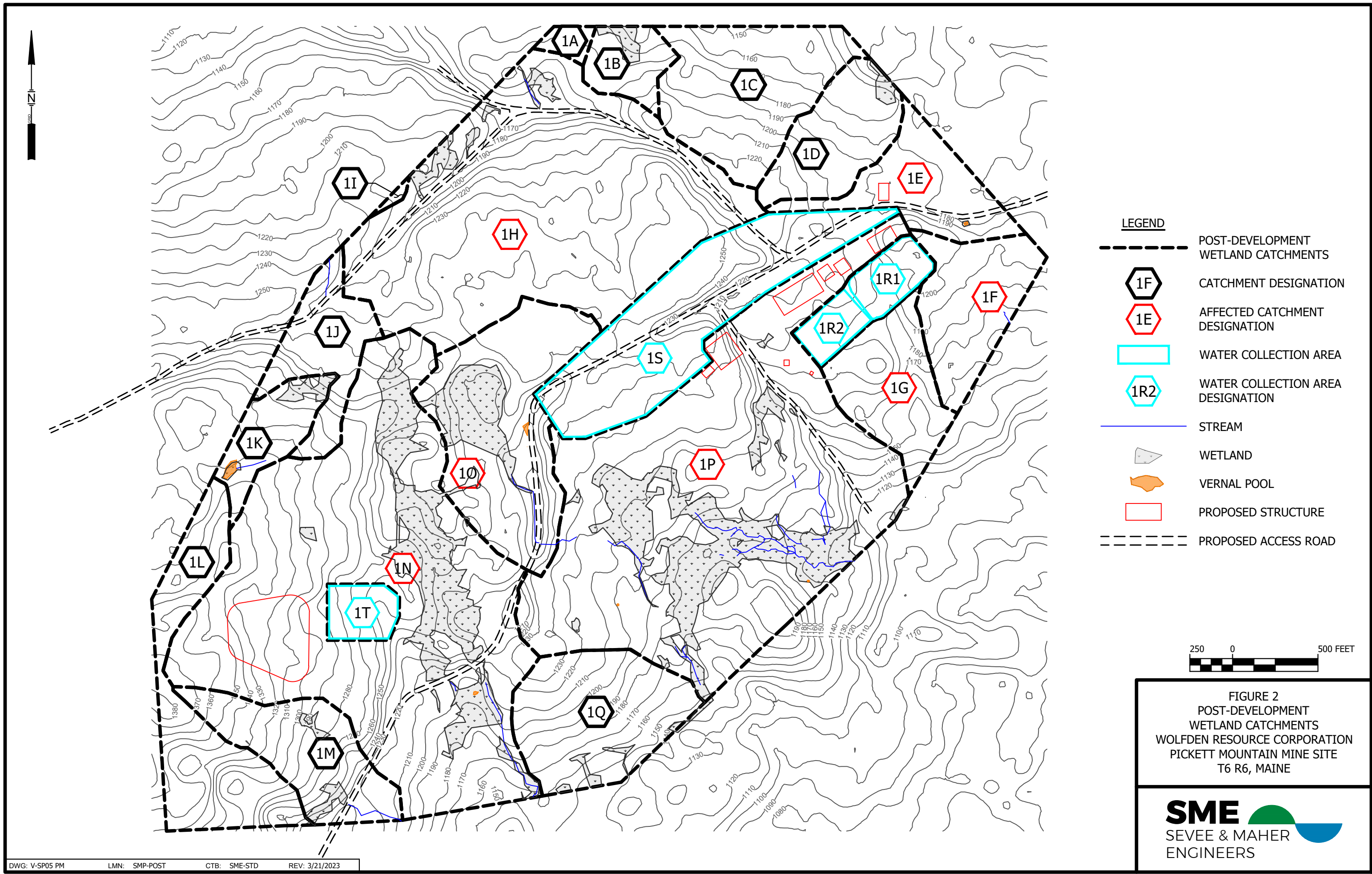
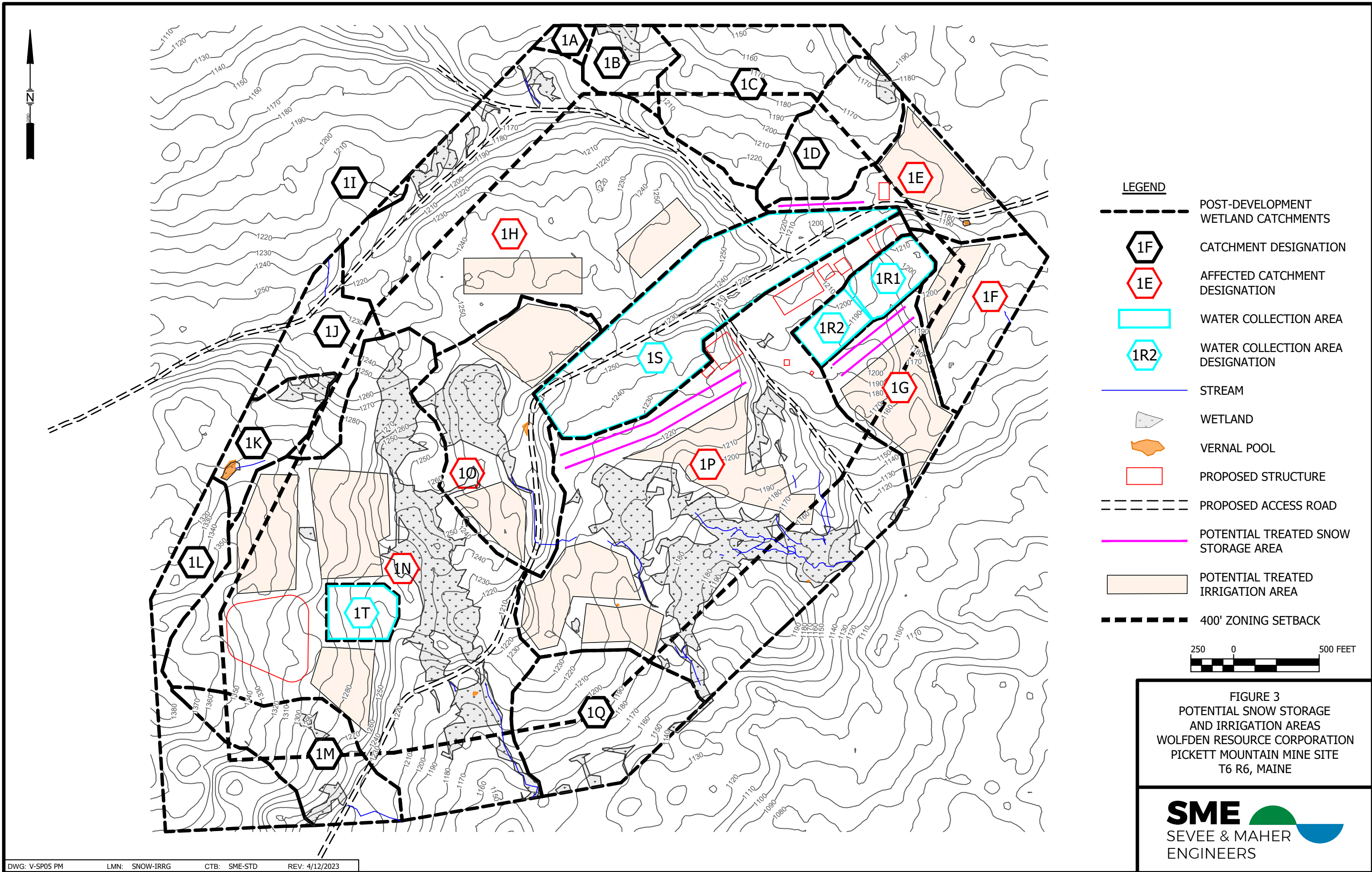

FIGURE 2  
 POST-DEVELOPMENT  
 WETLAND CATCHMENTS  
 WOLF DEN RESOURCE CORPORATION  
 PICKETT MOUNTAIN MINE SITE  
 T6 R6, MAINE





I:\SERVER\ctis\Wolfden\ACAD\Plans\BASE.dwg, FIG 3 - SNOW-IRRG, 4/12/2023 8:37:48 AM, jrl



**LEGEND**













-  POST-DEVELOPMENT WETLAND CATCHMENTS
-  CATCHMENT DESIGNATION
-  AFFECTED CATCHMENT DESIGNATION
-  WATER COLLECTION AREA
-  WATER COLLECTION AREA DESIGNATION
-  STREAM
-  WETLAND
-  VERNAL POOL
-  PROPOSED STRUCTURE
-  PROPOSED ACCESS ROAD
-  POTENTIAL TREATED SNOW STORAGE AREA
-  POTENTIAL TREATED IRRIGATION AREA
-  400' ZONING SETBACK

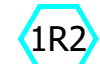

FIGURE 3  
 POTENTIAL SNOW STORAGE  
 AND IRRIGATION AREAS  
 WOLFDEN RESOURCE CORPORATION  
 PICKETT MOUNTAIN MINE SITE  
 T6 R6, MAINE

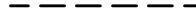

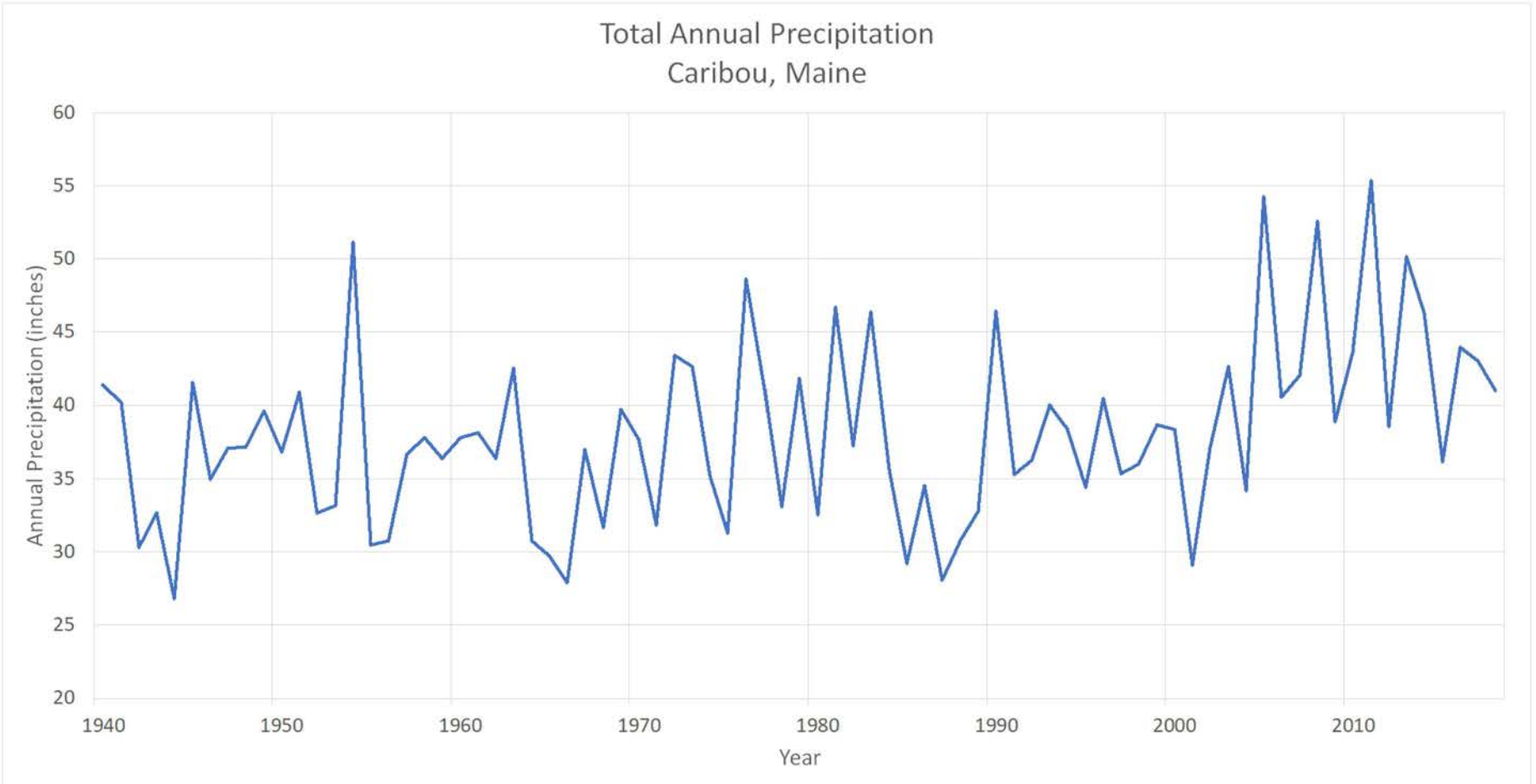
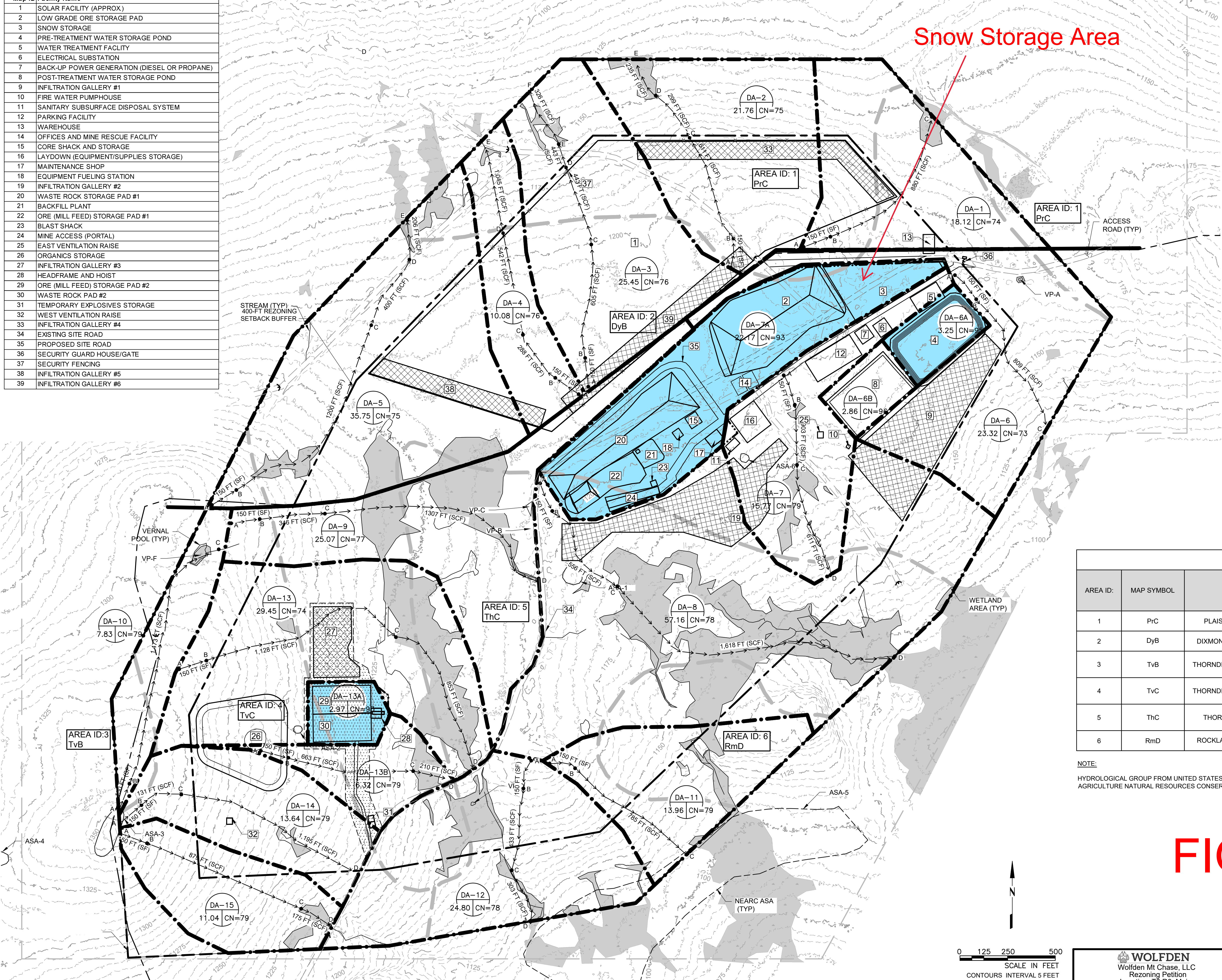

FIGURE 4  
TOTAL ANNUAL PRECIPITATION  
WOLF DEN RESOURCES CORPORATION  
PICKETT MOUNTAIN MINE SITE  
T6 R6, MAINE





Map ID	Facility Name
1	SOLAR FACILITY (APPROX)
2	LOW GRADE ORE STORAGE PAD
3	SNOW STORAGE
4	PRE-TREATMENT WATER STORAGE POND
5	WATER TREATMENT FACILITY
6	ELECTRICAL SUBSTATION
7	BACK-UP POWER GENERATION (DIESEL OR PROPANE)
8	POST-TREATMENT WATER STORAGE POND
9	INFILTRATION GALLERY #1
10	FIRE WATER PUMPHOUSE
11	SANITARY SUBSURFACE DISPOSAL SYSTEM
12	PARKING FACILITY
13	WAREHOUSE
14	OFFICES AND MINE RESCUE FACILITY
15	CORE SHACK AND STORAGE
16	LAYDOWN (EQUIPMENT/SUPPLIES STORAGE)
17	MAINTENANCE SHOP
18	EQUIPMENT FUELING STATION
19	INFILTRATION GALLERY #2
20	WASTE ROCK STORAGE PAD #1
21	BACKFILL PLANT
22	ORE (MILL FEED) STORAGE PAD #1
23	BLAST SHACK
24	MINE ACCESS (PORTAL)
25	EAST VENTILATION RAISE
26	ORGANICS STORAGE
27	INFILTRATION GALLERY #3
28	HEADFRAME AND HOIST
29	ORE (MILL FEED) STORAGE PAD #2
30	WASTE ROCK PAD #2
31	TEMPORARY EXPLOSIVES STORAGE
32	WEST VENTILATION RAISE
33	INFILTRATION GALLERY #4
34	EXISTING SITE ROAD
35	PROPOSED SITE ROAD
36	SECURITY GUARD HOUSE/GATE
37	SECURITY FENCING
38	INFILTRATION GALLERY #5
39	INFILTRATION GALLERY #6



**LEGEND:**

- BOUNDARY DRAINAGE
- TC FLOW PATH
- MINE FACILITY DRAINAGE AREAS WHERE PRECIPITATION RUNOFF IS COLLECTED AND TREATED
- EXISTING CONTOURS
- SOIL SERIES BOUNDARY
- STREAM
- PICKETT MOUNTAIN POND / PLEASANT LAKE WATERSHED DIVIDE
- WETLAND
- 400-FOOT REZONING SETBACK BUFFER
- PROPOSED REZONING
- VERNAL POOLS

**ABBREVIATION:**

- DA - DRAINAGE AREA
- TC - TIME OF CONCENTRATION
- CN - CURVE NUMBER
- POA - POINT OF ANALYSIS
- SF - SHEET FLOW
- SCF - SHALLOW CONCENTRATION FLOW

**DA=7**  
25.50 CN=98  
AREA IN ACRES

SOIL KEY					
AREA ID:	MAP SYMBOL	SOIL SERIES	DRAINAGE CONDITION	SLOPE (%)	HYDROGRAPHICAL GROUP
1	PrC	PLAISTED VERY STONY LOAM	WELL DRAINED	8-15	C
2	DyB	DIXMONT VERY STONY SILT LOAM	SOMEWHAT POORLY DRAINED	2-8	C/D
3	TvB	THORNDIKE VERY STONY SILT LOAM	SOMEWHAT EXCESSIVELY DRAINED	2-8	D
4	TvC	THORNDIKE VERY STONY SILT LOAM	SOMEWHAT EXCESSIVELY DRAINED	8-15	D
5	ThC	THORNDIKE SHALY SILT LOAM	SOMEWHAT EXCESSIVELY DRAINED	8-15	D
6	RmD	ROCKLAND, THORNDIKE MATERIA	EXCESSIVE DRAINAGE	15-25	-

**NOTE:**  
HYDROLOGICAL GROUP FROM UNITED STATES DEPARTMENT OF AGRICULTURE NATURAL RESOURCES CONSERVATION SERVICE

# FIGURE 5

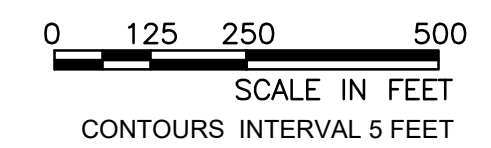

**WOLFDEN**  
Wolfden Mt Chase, LLC  
Rezoning Petition  
Location: T6 R6, Maine

**wood.**  
Environment & Infrastructure Solutions, Inc.  
511 Congress St., Suite 200, Portland, ME 04101  
P: (207) 775-5481 F: (207) 772-4762 www.woodco.com

Prepared/Date: WJM 08/24/22  
Checked/Date: MAP 08/24/22

PROPOSED WATERSHED CONDITIONS  
Project 3617-19-7478  
Figure 2

C:\Users\william.williams\OneDrive - Wood - F:\C\Projects\Wolfden - Resources\B.O. Drenning\Design - 2022\Sheets\Figure 2 - Watershed Proposed Conditions.dwg Wed Aug 24 2022 9:40am william.williams



**ATTACHMENT 1**

**SPRAY IRRIGATION SYSTEMS AND EQUIPMENT**

**FOR MORE INFORMATION:**

<https://www.kometirrigation.com/products/big-sprinkler/long-distance-sprinkler>



WASTEWATER SPRAY IRRIGATION SYSTEMS

## Nelson SR150 End Gun, Part Circle



SKU: SR150

Brand: [Nelson](#)

\$2177.32

Qty:

---

### Description

*Nelson SR150 End Gun, Part Circle is Valley, Lindsay/Zimmatic, Reinke, Pierce, Olson and Lockwood compatible.*

Nelson SR150 End Gun, Part Circle

150 Series Big Gun

The 150 Series is a perfect fit for solid set irrigation, traveler irrigation and dust suppression. Anodized, Powder Coated or Stainless Steel units are available, which makes this a great option for mining or wastewater applications.

The Nelson 150 Series Big Gun Part Circle (21 , 24 , 27 , 43 , or 15 -45 adjustable trajectory) sprinkler. Taper, Taper Ring, or Taper Bore Nozzles are available.





# **YUZUAK JET 35T 2" CLEAN/DIRTY WATER GEAR DRIVE RAIN GUN**

## **Item Information**

Condition:

Bulk savings:

2 or more for \$399.97/eaBuy 2 or more for 399.97 each one



INNOVATIVE  
IRRIGATION

## komet | *Sprinklers*

### **Universal Sprinklers**

for Solid-set Systems

### **Universale Regner**

für ortsfeste Anlagen



THE KOMET ADVANTAGE:  
INNOVATION WITH IMPACT



# komet | *Sprinklers*

While conceiving new products, we must make sure that they meet the values in which we strongly believe: quality, reliability and a solid advantage to the customer. The quality of a product is a reflection of what the people who create, manufacture and market it, stand for. This approach to our work is very important to us.

Reliability is achieved by using the most suitable and functional materials for the intended purpose as well as implementing the strictest quality controls in every step throughout the manufacturing process of our products. The advantage to the customer is found in our efforts to offer products of highest quality and reliability combined with innovative features that we implement in all of them.

The Komet Universal Sprinklers represent our capacity to integrate innovative technology, performance and reliability.

Ein neues Produkt spiegelt immer auch die Menschen, die an seiner Entwicklung und Herstellung beteiligt waren. Und die Überzeugungen, für welche diese Menschen stehen. Für uns sind das Werte wie Qualität, absolute Zuverlässigkeit und ein immanenter Vorteil für den Anwender. Für diesen Anspruch stehen wir ein. Wir glauben an das, was wir tun und vor allem daran, wie wir es tun.

Unser Qualitätsanspruch beginnt mit der Verwendung des besten Materials. Innovatives Ingenieurwissen fließt in die Konzeption und Erprobung neuer Produkte ein. Der Fertigungsprozess schließlich ist von engmaschigen Qualitätskontrollen begleitet und sichert so die Solidität und Langlebigkeit unserer Produkte. Die Komet Universal Regner sind das Ergebnis dieses perfekten Zusammenspiels von innovativer Technologie, Leistung und Zuverlässigkeit.



## Komet Philosophy

We are a family business. We inherited the values that are the foundation of our relationships from the company's founder Roland Drechsel, our father. For us, the order of the day is honesty, respect and trust. We believe that in today's world, rather than inventing new promises, it is far more important to respect, uphold and build on the customer promises that our company was founded on. In addition to providing the highest quality irrigation equipment, we want to make sure our customers have water application products that operate at the highest levels of efficiency and effectiveness, which in turn will help to limit the waste of our natural resources. We believe in building long lasting relationships with our customers. This gives us the opportunity to understand their needs, analyze how our products are meeting those needs, and to continue to improve. We believe in what we do, and are passionate about how we do it.

## Komet Philosophie

Wir sind ein Familienunternehmen. Und als solches fühlen wir uns den Werten und der Tradition, für die schon unser Vater Roland Drechsel als Unternehmensgründer eingestanden ist, weiterhin verpflichtet. Ehrlichkeit, Respekt und Vertrauen stehen für uns an erster Stelle. Für uns sind sie – auch und gerade in Zeiten des globalisierten Business – die Basis erfolgreicher Geschäftsbeziehungen. Dass ein gegebenes Versprechen eingehalten wird, dass Vereinbarungen für uns verbindlich sind – das erscheint uns heute wichtiger denn je. Als kompetenter und verlässlicher Partner helfen wir unseren Kunden, die optimale Beregnung zu gewährleisten – bei höchster Effizienz und maximaler Schonung der Ressourcen. Wir bemühen uns um langfristige und tragfähige Beziehungen zu unseren Kunden. Der intensive Austausch mit den Kunden und eine genaue Analyse der jeweiligen Rahmenbedingungen und Erfahrungen ermöglichen es uns, individuelle Lösungen anzubieten und bestehende Konzepte gegebenenfalls zu optimieren. Eine Vielzahl langjähriger Geschäftsbeziehungen spricht dafür, dass dieser Weg der richtige ist.



## Operating Cost

VS

## Purchase Cost

A trend has been developing in the past few years in which the purchase cost of a product has become the most important factor when purchasing equipment. This trend has changed the scope of many companies, moving to a short term market approach that focuses on the purchase cost instead of its real operating cost. We at Komet are firmly convinced that our customers generate greater benefit by optimizing the operating cost of the products they use. Our priorities when developing products are to make sure that they are the most reliable, always operate at the optimum efficiency, are easy to use and minimize the waste of precious natural resources. It is surely less demanding and more economically feasible to concentrate a company's product lines with the short term market approach, but we believe that the credibility of our brand is based on the long term quality and performance of our products, and more importantly the return on investment our customers can realize.

## Betriebskosten

VS

## Anschaffungskosten

Zu den Marktgesetzen der jüngeren Vergangenheit zählt es, dass die Anschaffungskosten eines Produktes im Vordergrund stehen. Das ist verständlich, steht einer nachhaltigen Kosten-Nutzen-Analyse aber oft im Weg. Gerade bei langlebigen Produkten wie unseren, die viele Jahre im Einsatz sind, entscheiden in erster Linie die Betriebskosten und die Wartungs- und Reparaturfrequenzen über die tatsächliche Rentabilität. Wir von Komet sind davon überzeugt, dass durch die Optimierung der Betriebskosten der eigentliche Mehrwert für den Kunden entsteht. Deshalb konzentrieren wir uns bei der Entwicklung unserer Produkte auf hohe Zuverlässigkeit, einfache Bedienbarkeit und eine optimale, Ressourcen schonende Effizienz. Etwas kostengünstigere Lösungen mögen auf den ersten Blick ökonomischer sein. Auf lange Sicht aber bewähren sich eben diese den individuellen Bedürfnissen angepassten Produkte, die sich durch hohe Qualität und Langlebigkeit und vergleichsweise geringe Betriebskosten auszeichnen. Auch dafür geben wir unser Wort.

# The Advantages / Die Vorteile

## 1.

### WATER DISTRIBUTION WASSERVERTEILUNG

Water distribution is a very important aspect in irrigation and therefore it is important to develop devices with improved performance levels. The Komet Sprinkler product line offers great performance with an excellent water distribution uniformity even in lower pressure conditions.

Die Wasserverteilung ist ein sehr wichtiger Aspekt in der Beregnung und deshalb ist es wichtig, Geräte mit immer besseren Leistungen zu entwickeln. Die Komet Sprinkler Produktlinie bietet höchste Leistung mit ausgezeichneter Wasserverteilung und dies auch bei geringeren Betriebsdrücken.

## 2.

### THROW WURFWEITE

A longer throw results in a larger irrigated area and this factor is fundamental to the cost effectiveness of the irrigation. Due to the hydraulic design of the sprinklers the water reaches the nozzle with the least possible turbulences and pressure losses allowing for best throw values.

Die Wurfweite bestimmt die berechnete Fläche: je größer die Wurfweite desto größer die berechnete Fläche, was wiederum die Wirtschaftlichkeit steigert. Durch den optimal gestalteten Wasserdurchfluss der Komet Regner gelangt das Wasser mit den geringst möglichen Turbulenzen und Druckverlusten zur Düse und ermöglicht so große Wurfweiten.

## 3.

### EFFICIENCY EFFIZIENZ

All irrigation operations need to achieve a correct cost balance. The quality materials used manufacturing the Komet Sprinklers allow for a long service life making them highly efficient and cost effective in a long term vision.

Die Beregnung muss in einem vernünftigen Kostenrahmen stattfinden. Die in der Fertigung verwendete Qualität der Materialien lassen eine lange Lebensdauer der Komet Produkte erwarten was sich auf lange Sicht wirtschaftlich sehr positiv auswirkt.

## 4.

### RELIABILITY ZUVERLÄSSIGKEIT

For every grower the dependability of the products he is working with is most important when he is irrigating. To make sure to achieve this goal Komet has set high standards in selecting the materials and has adopted strict quality controls throughout the manufacturing process because in the field quality matters.

Für jeden Anwender ist die Zuverlässigkeit der benutzten Arbeitsmittel das Allerwichtigste. Aus diesem Grund hat Komet schon immer die besten Materialien und Produktionstechniken eingesetzt, da am Feld die Zuverlässigkeit der Arbeitsgeräte von entscheidender Bedeutung ist.

## 5.

### ADAPTABILITY ANPASSUNGSFÄHIGKEIT

To be an effective working tool it must be adaptable to the requirements of the different usages. Komet has developed a complete product line to best adapt to the requirements of the growers and the different irrigation system requirements while delivering always best possible performance.

Um effizient zu sein, muss sich jedes Arbeitsgerät den verschiedenen Anforderungen anpassen können. Komet hat eine komplette Serie von Produkten entwickelt, welche sich bestens den Anforderungen der Anwender und der unterschiedlichen Beregnungssysteme anpassen lässt und dabei immer bestmögliche Leistung erbringt.



**The Result /  
Das Resultat**





# komet | Sprinkler 163



Part and full circle model  
Sektor- und Kreisregner

Thread 1 1/2" FBSP  
IG-Anschluss 1 1/2" BSP

Dimensions /  
Abmessungen

458 mm

247 mm

This medium volume sprinkler is suitable for versatile use in general field irrigation on solid-set and mechanized irrigation systems such as travellers. Changing from part circle to full circle operation is easy by adjusting the part circle stops. The Komet 163 shows good performance in windy conditions, and complements the full circle model Komet 162 where irrigation of adjacent fields is not allowed. Long wear life, high performance, proven design and maintenance free operation are among other its outstanding features.

Universal Sektor- und Kreisregner für die Mittelstarkberegnung. Die Anwendung erschließt den gesamten Bereich der extensiven landwirtschaftlichen Kulturen. Der Komet 163 findet auch Einsatz auf Beregnungsmaschinen. Er ist leistungsstark, wartungsfrei, von robuster Bauart und kann schnell von Sektor- auf Kreisbetrieb umgestellt werden.

Nozzle Düse	Pressure Druck	Throw Wurf- weite	Flow Durchfluss		Surface Fläche	Precipitation rate Regenhöhe	▲ Set-up / Verband			■ Set-up / Verband		
			m <sup>3</sup> /h	l/sec			Spacing Regner- abstand max. m	Surface Fläche m <sup>2</sup>	Precipitation rate Regenhöhe mm/h	Spacing Regner- abstand max. m	Surface Fläche m <sup>2</sup>	Precipitation rate Regenhöhe mm/h
8	2	19,5	5,377	1,494	1158	4,64	28/33	942	5,71	27	729	7,38
	3	22,0	6,585	1,829	1466	4,49	32/37	1184	5,56	30	900	7,32
	4	24,0	7,604	2,112	1779	4,27	32/41	1454	5,23	34	1156	6,58
	5	25,5	8,501	2,361	2059	4,13	38/44	1675	5,08	36	1296	6,56
10	2	21,5	6,855	1,904	1385	4,95	31/36	1122	6,11	30	900	7,62
	3	24,0	8,396	2,332	1750	4,80	35/41	1554	5,40	33	1089	7,71
	4	26,5	9,695	2,693	2124	4,56	39/45	1752	5,53	37	1369	7,08
	5	28,5	10,839	3,011	2463	4,40	42/48	1994	5,44	39	1521	7,13
12	2	23,0	8,771	2,436	1576	5,57	34/39	1315	6,67	32	1024	8,57
	3	26,0	10,742	2,984	2027	5,30	38/44	1675	6,41	36	1296	8,29
	4	28,5	12,404	3,445	2463	5,04	42/48	1994	6,22	39	1521	8,15
	5	30,5	13,868	3,852	2865	4,84	45/52	2340	5,93	43	1849	7,50
14	2	24,0	11,045	3,068	1720	6,42	35/40	1358	8,13	33	1089	10,14
	3	27,5	13,527	3,757	2290	5,91	41/47	1911	7,08	38	1444	9,37
	4	30,0	15,619	4,339	2715	5,75	44/51	2250	6,94	41	1681	9,29
	5	32,0	17,463	4,851	3097	5,64	47/54	2524	6,92	44	1936	9,02
16	2	24,5	13,083	3,634	1809	7,23	35/41	1554	8,42	34	1156	11,32
	3	28,5	16,024	4,451	2463	6,51	42/48	1994	8,04	39	1521	10,53
	4	31,5	18,503	5,140	3019	6,13	47/54	2524	7,33	44	1936	9,56
	5	33,5	20,686	5,746	3380	6,12	49/57	2811	7,36	46	2116	9,78
6	34,5	22,661	6,295	3674	6,17	51/59	3012	7,52	48	2304	9,84	

N.B.: The performance data were obtained under ideal testing conditions and may be adversely affected by wind and other factors. Pressure refers to pressure at nozzle. Consider wind speed and wind direction when designing an irrigation system. Reduce the spacing for the selected sprinkler set-up accordingly. Die in der Tabelle angegebenen Daten beziehen sich auf Windstille und können durch Windeinfluss oder andere Faktoren negativ beeinflusst werden. Der angegebene Betriebsdruck bezieht sich auf den Druck an der Düse. Bei Auslegung von Beregnungsanlagen sind Windrichtung und Windgeschwindigkeit zu berücksichtigen. Die Regnerabstände sind im Verband entsprechend zu verringern.

# komet | Sprinkler 162

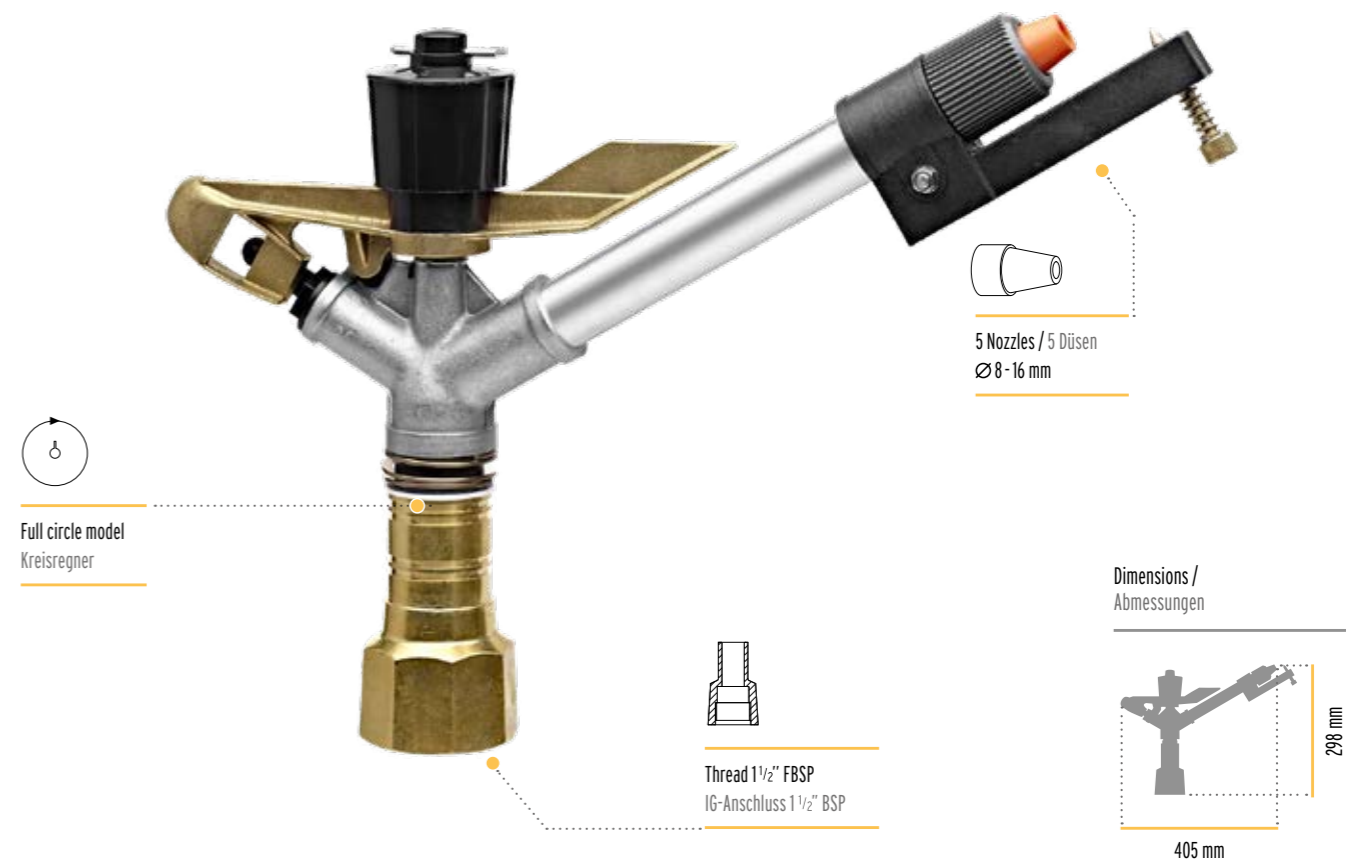

Full circle model  
Kreisregner

Thread 1 1/2" FBSP  
IG-Anschluss 1 1/2" BSP

Dimensions /  
Abmessungen

405 mm

298 mm

The Komet 162 is a medium volume sprinkler with full circle operation and the same performance and features as the Komet 163. Designed for use in general field irrigation mainly in extensive solid-set and moveable irrigation systems. Long wear life, high performance, proven design and maintenance free operation are among other its outstanding features.

Der Komet 162 ist ein Universal Kreisregner für die Mittelstarkberegnung. Die Anwendung erschließt das ganze Gebiet der extensiven landwirtschaftlichen Kulturen, insbesondere findet der Komet 162 weitgehend Einsatz in ausgedehnten ortsfesten Anlagen. Der Komet 162 ist leistungsstark, wartungsfrei und von robuster Bauart.

Nozzle Düse	Pressure Druck	Throw Wurf- weite	Flow Durchfluss		Surface Fläche	Precipitation rate Regenhöhe	▲ Set-up / Verband			■ Set-up / Verband		
			m <sup>3</sup> /h	l/sec			Spacing Regner- abstand max. m	Surface Fläche m <sup>2</sup>	Precipitation rate Regenhöhe mm/h	Spacing Regner- abstand max. m	Surface Fläche m <sup>2</sup>	Precipitation rate Regenhöhe mm/h
8	2	19,5	6,293	1,748	1158	5,43	28/33	942	6,68	27	729	8,63
	3	22,0	7,708	2,141	1466	5,26	32/37	1184	6,51	30	900	8,56
	4	24,0	8,900	2,472	1779	5,00	32/41	1454	6,12	34	1156	7,70
	5	25,5	9,950	2,764	2059	4,83	38/44	1675	5,94	36	1296	7,68
10	2	21,5	8,079	2,244	1385	5,83	31/36	1122	7,20	30	900	8,98
	3	24,0	9,895	2,749	1750	5,65	35/41	1454	6,81	33	1089	9,09
	4	26,5	11,425	3,174	2124	5,38	39/45	1752	6,52	37	1369	8,35
	5	28,5	12,774	3,548	2463	5,19	42/48	1994	6,41	39	1521	8,40
12	2	23,0	9,981	2,773	1576	6,33	34/39	1315	7,59	32	1024	9,75
	3	26,0	12,225	3,396	2027	6,03	38/44	1675	7,30	36	1296	9,43
	4	28,5	14,116	3,921	2463	5,73	42/48	1994	7,08	39	1521	9,28
	5	30,5	15,782	4,384	2865	5,51	45/52	2340	6,74	43	1849	8,54
14	2	24,0	12,354	3,432	1720	7,18	35/40	1385	8,92	33	1089	11,34
	3	27,5	15,130	4,203	2290	6,61	41/47	1911	7,92	38	1444	10,48
	4	30,0	17,471	4,853	2715	6,44	44/51	2250	7,76	41	1681	10,39
	5	32,0	19,533	5,426	3097	6,31	47/54	2524	7,74	44	1936	10,09
16	2	24,5	14,483	4,023	1809	8,01	35/41	1454	9,96	34	1156	12,53
	3	28,5	17,738	4,927	2463	7,20	42/48	1994	9,08	39	1521	11,66
	4	31,5	20,482	5,689	3019	6,78	47/54	2524	8,11	44	1936	10,58
	5	33,5	22,899	6,361	3380	6,77	49/57	2811	8,15	46	2116	10,82
6	34,5	25,085	6,968	3674	6,83	51/59	3012	8,33	48	2304	10,89	

N.B.: The performance data were obtained under ideal testing conditions and may be adversely affected by wind and other factors. Pressure refers to pressure at nozzle. Consider wind speed and wind direction when designing an irrigation system. Reduce the spacing for the selected sprinkler set-up accordingly. Die in der Tabelle angegebenen Daten beziehen sich auf Windstille und können durch Windeinfluss oder andere Faktoren negativ beeinflusst werden. Der angegebene Betriebsdruck bezieht sich auf den Druck an der Düse. Bei Auslegung von Beregnungsanlagen sind Windrichtung und Windgeschwindigkeit zu berücksichtigen. Die Regnerabstände sind im Verband entsprechend zu verringern.

# komet | Sprinkler R20



The Komet R20 is a medium / low volume sprinkler and is suitable for versatile use in general field irrigation on solid-set and mechanized irrigation systems such as travellers. The Komet R20 shows good performance also in medium to low pressures conditions. Long wear life, high performance, proven design and maintenance free operation are among other its outstanding features.

Der Komet R20 ist ein Universal Sektor- und Kreisregner für die Mittelstark- und Schwachberegnung. Die Anwendung erschließt den gesamten Bereich der extensiven landwirtschaftlichen Kulturen. Er wird auch auf Beregnungsmaschinen eingesetzt. Er ist leistungsstark, wartungsfrei, von robuster Bauart und kann schnell von Sektor- auf Kreisbetrieb umgestellt werden.

Nozzle Düse	Pressure Druck	Throw Wurf- weite	Flow Durchfluss		Surface Fläche	Precipitation rate Regenhöhe	▲ Set-up / Verband			■ Set-up / Verband		
			m <sup>3</sup> /h	l/sec			Spacing Regner- abstand	Surface Fläche	Precipitation rate Regenhöhe	Spacing Regner- abstand	Surface Fläche	Precipitation rate Regenhöhe
mm	bar	m	m <sup>3</sup> /h	l/sec	m <sup>2</sup>	mm/h	max. m	m <sup>2</sup>	mm/h	max. m	m <sup>2</sup>	mm/h
6	2,5	16,5	2,09	0,582	855	2,44	24/28	678	3,08	23	529	3,95
	3,5	19,0	2,48	0,689	1133	2,19	28/33	942	2,63	26	676	3,67
	4,5	21,0	2,81	0,781	1385	2,03	31/36	1121	2,51	29	841	3,34
7	2,0	16,5	2,55	0,709	855	2,98	24/28	678	3,76	23	529	4,82
	3,0	19,0	3,12	0,868	1133	2,75	28/33	942	3,31	26	676	4,61
	4,0	21,0	3,61	1,002	1385	2,60	31/36	1121	3,22	29	841	4,29
8	2,0	18,0	3,33	0,926	1017	3,27	26/31	931	4,01	25	625	5,33
	3,0	21,0	4,08	1,134	1385	2,94	31/36	1121	3,64	29	841	4,85
	4,0	22,5	4,72	1,310	1590	2,97	33/39	1315	3,59	31	941	4,91
10	2,0	19,5	5,21	1,447	1194	4,36	28/33	942	5,53	27	729	7,15
	3,0	22,0	6,38	1,772	1520	4,20	33/38	1249	5,11	31	961	6,64
	4,0	24,0	7,36	2,046	1808	4,07	35/41	1454	5,06	34	1156	6,36
12	2,5	22,0	8,38	2,329	1520	5,51	33/38	1249	6,71	31	961	8,72
	3,5	24,0	9,92	2,756	1808	5,48	35/41	1454	6,42	34	1156	8,58
	4,5	26,0	11,25	3,125	2122	5,30	39/45	1751	6,42	36	1296	8,68

N.B.: The performance data were obtained under ideal testing conditions and may be adversely affected by wind and other factors. Pressure refers to pressure at nozzle. Consider wind speed and wind direction when designing an irrigation system. Reduce the spacing for the selected sprinkler set-up accordingly. Die in der Tabelle angegebenen Daten beziehen sich auf Windstille und können durch Windeinfluss oder andere Faktoren negativ beeinflusst werden. Der angegebene Betriebsdruck bezieht sich auf den Druck an der Düse. Bei Auslegung von Beregnungsanlagen sind Windrichtung und Windgeschwindigkeit zu berücksichtigen. Die Regnerabstände sind im Verband entsprechend zu verringern.

# komet | Sprinkler R8



The Komet R8 is a medium / low volume sprinkler and is suitable for versatile use in general field irrigation on solid-set systems. The Komet R8 shows good performance also in medium to low pressures conditions. Long wear life, high performance, proven design and maintenance free operation are among other its outstanding features.

Der Komet R8 ist ein Universal Kreisregner für die Mittelstark- und Schwachberegnung. Die Anwendung erschließt das ganze Gebiet der extensiven landwirtschaftlichen Kulturen, insbesondere findet der Komet R8 weitgehend Einsatz in ausgedehnten ortsfesten Anlagen. Der Komet R8 ist leistungsstark, wartungsfrei und von robuster Bauart.

Nozzle Düse	Pressure Druck	Throw Wurf- weite	Flow Durchfluss		Surface Fläche	Precipitation rate Regenhöhe	▲ Set-up / Verband			■ Set-up / Verband		
			m <sup>3</sup> /h	l/sec			Spacing Regner- abstand	Surface Fläche	Precipitation rate Regenhöhe	Spacing Regner- abstand	Surface Fläche	Precipitation rate Regenhöhe
mm	bar	m	m <sup>3</sup> /h	l/sec	m <sup>2</sup>	mm/h	max. m	m <sup>2</sup>	mm/h	max. m	m <sup>2</sup>	mm/h
6	1,5	14,0	1,62	0,451	615	2,63	20/24	498	3,25	19	361	4,49
	2,5	16,5	2,09	0,582	855	2,44	24/28	678	3,08	23	529	3,95
	3,5	19,0	2,48	0,689	1133	2,19	28/33	942	2,63	26	676	3,67
	4,5	21,0	2,81	0,781	1385	2,03	31/36	1121	2,51	29	841	3,34
7	2,0	16,5	2,55	0,709	855	2,98	24/28	678	3,76	23	529	4,82
	3,0	19,0	3,12	0,868	1133	2,75	28/33	942	3,31	26	676	4,61
	4,0	21,0	3,61	1,002	1385	2,60	31/36	1121	3,22	29	841	4,29
	4,0	21,0	3,61	1,002	1385	2,60	31/36	1121	3,22	29	841	4,29
8	2,0	18,0	3,33	0,926	1017	3,27	26/31	931	4,01	25	625	5,33
	3,0	21,0	4,08	1,134	1385	2,94	31/36	1121	3,64	29	841	4,85
	4,0	22,5	4,72	1,310	1590	2,97	33/39	1315	3,59	31	941	4,91
	4,0	22,5	4,72	1,310	1590	2,97	33/39	1315	3,59	31	941	4,91
10	2,0	19,5	5,21	1,447	1194	4,36	28/33	942	5,53	27	729	7,15
	3,0	22,0	6,38	1,772	1520	4,20	33/38	1249	5,11	31	961	6,64
	4,0	24,0	7,36	2,046	1808	4,07	35/41	1454	5,06	34	1156	6,36
	4,0	24,0	7,36	2,046	1808	4,07	35/41	1454	5,06	34	1156	6,36
12	2,5	22,0	8,38	2,329	1520	5,51	33/38	1249	6,71	31	961	8,72
	3,5	24,0	9,92	2,756	1808	5,48	35/41	1454	6,42	34	1156	8,58
	4,5	26,0	11,25	3,125	2122	5,30	39/45	1751	6,42	36	1296	8,68
	4,5	26,0	11,25	3,125	2122	5,30	39/45	1751	6,42	36	1296	8,68

N.B.: The performance data were obtained under ideal testing conditions and may be adversely affected by wind and other factors. Pressure refers to pressure at nozzle. Consider wind speed and wind direction when designing an irrigation system. Reduce the spacing for the selected sprinkler set-up accordingly. Die in der Tabelle angegebenen Daten beziehen sich auf Windstille und können durch Windeinfluss oder andere Faktoren negativ beeinflusst werden. Der angegebene Betriebsdruck bezieht sich auf den Druck an der Düse. Bei Auslegung von Beregnungsanlagen sind Windrichtung und Windgeschwindigkeit zu berücksichtigen. Die Regnerabstände sind im Verband entsprechend zu verringern.



# komet | Sprinkler F41 - F41/2 - F43

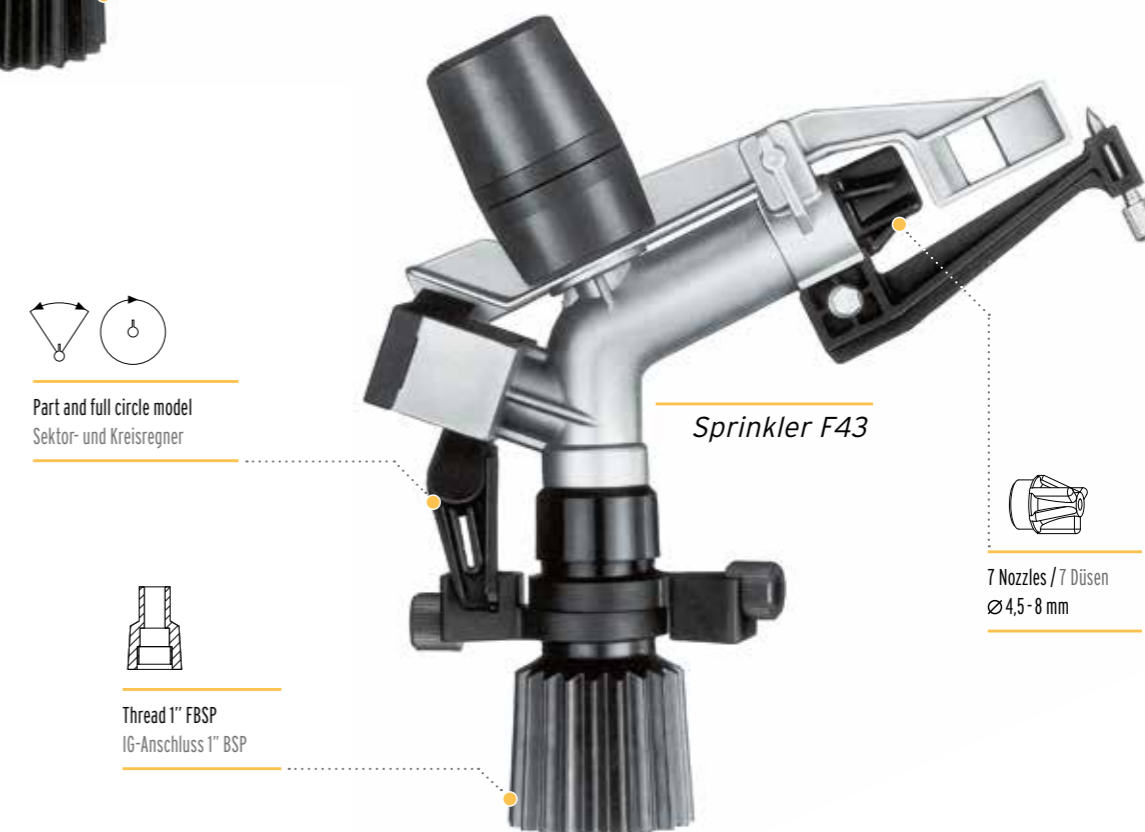
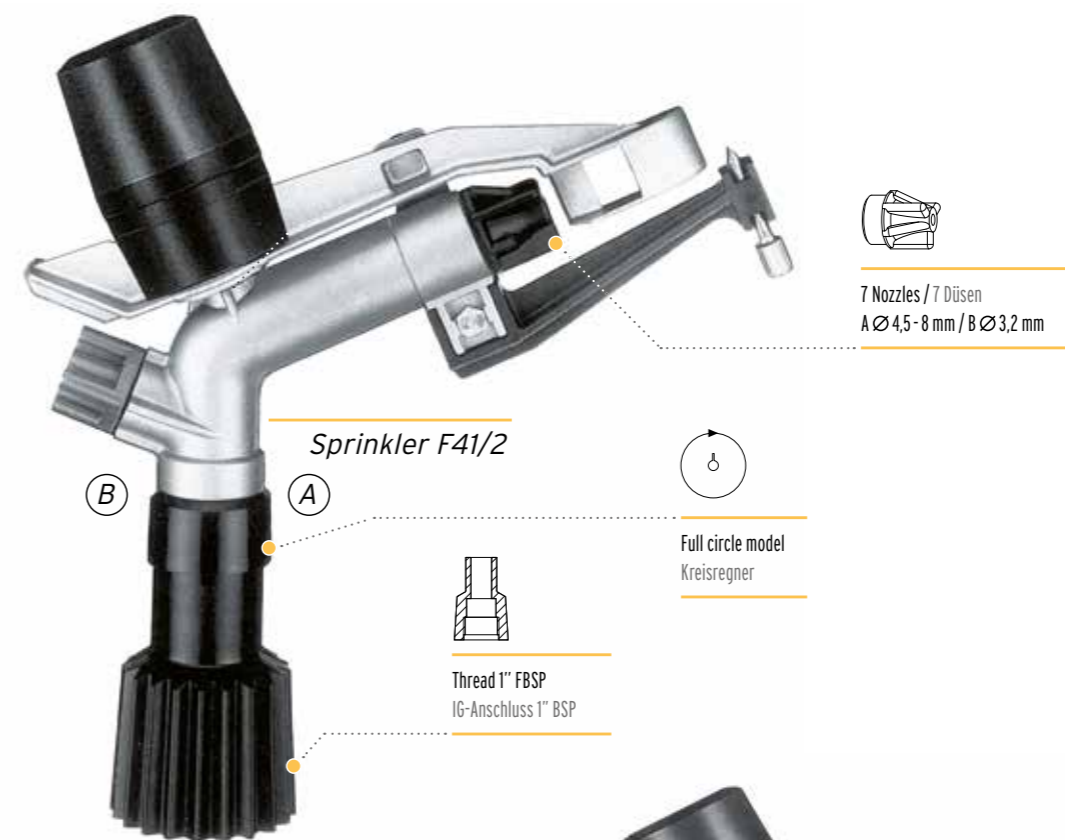
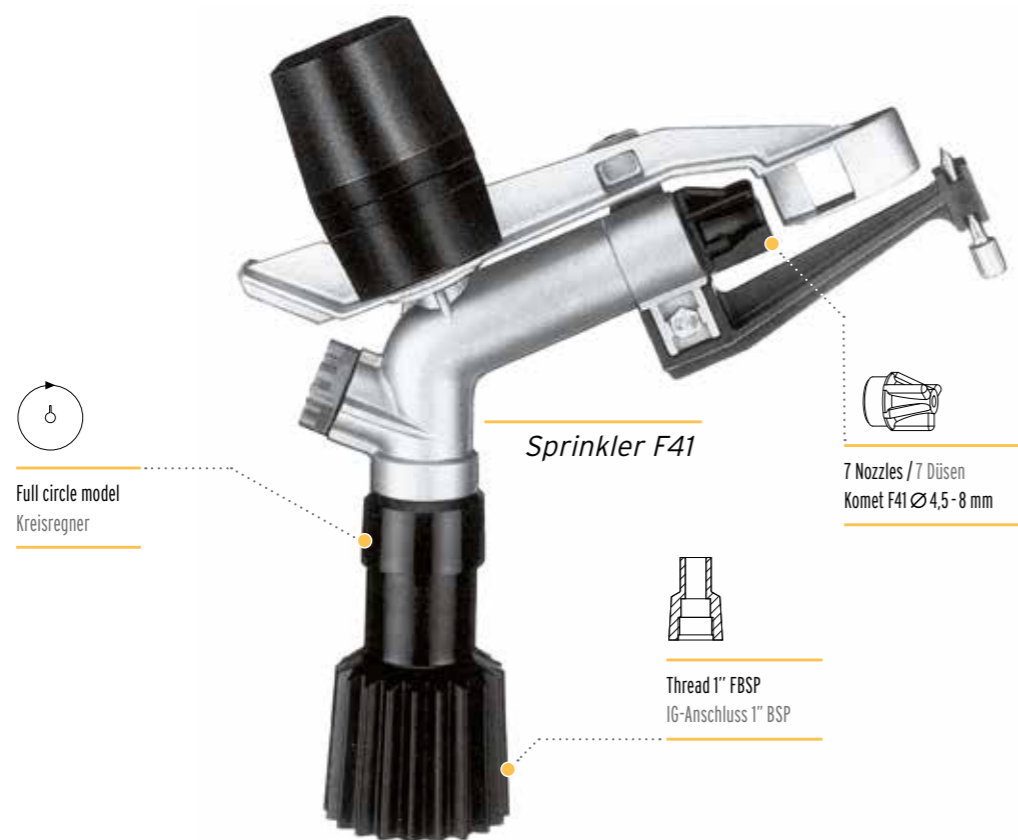

## komet | Sprinkler F41

The Komet F41, single jet and full circle sprinkler, is suitable for versatile use on solid-set irrigation systems. The Komet F41 shows good performance also in medium to low pressures conditions and an outstanding uniformity in the water distribution. Long wear life, high performance, proven design and maintenance free operation are among other its outstanding features.

Der Komet F41, Einstrahl-Kreisregner für die Schwachberegnung findet weitgehend Einsatz in ortsfesten Anlagen. Ausgezeichnete Funktion und Wasserverteilung auch bei Niederdruck. Der Komet F41 ist leistungsstark, wartungsfrei und von robuster Bauart.

## komet | Sprinkler F41/2

The Komet F41/2, double jet and full circle sprinkler, is suitable for versatile use on solid-set irrigation systems. The Komet F41/2 shows good performance also in medium to low pressures conditions and an outstanding uniformity in the water distribution. Long wear life, high performance, proven design and maintenance free operation are among other its outstanding features.

Der Komet F41/2, Zweistrahler-Kreisregner für die Schwachberegnung findet weitgehend Einsatz in ortsfesten Anlagen. Ausgezeichnete Funktion und Wasserverteilung auch bei Niederdruck. Der Komet F41/2 ist leistungsstark, wartungsfrei und von robuster Bauart.

## komet | Sprinkler F43

The Komet F43, part and full circle sprinkler is suitable for versatile use on solid-set irrigation systems. The Komet F43 shows good performance also in medium to low pressures conditions. Changing from part circle to full circle operation is easy by adjusting the part circle stops. Long wear life, high performance, proven design and maintenance free operation are among other its outstanding features.

Der Komet F43, Kreis- und Sektorregner für die Schwachberegnung findet weitgehend Einsatz in ortsfesten Anlagen. Ausgezeichnete Funktion und Wasserverteilung auch bei Niederdruck. Der Komet F43 ist leistungsstark, wartungsfrei und von robuster Bauart und kann schnell von Sektor- auf Kreisbetrieb umgestellt werden.

# komet | Sprinkler F41 -F43

Dimensions / Abmessungen

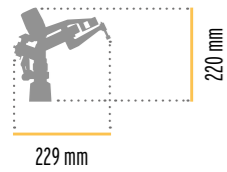

Dimensions / Abmessungen

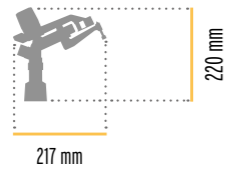

Nozzle Düse	Pressure Druck	Throw Wurf- weite	Flow / Durchfluss		Surface Fläche	Precipitation rate Regenhöhe	▲ Set-up / Verband			■ Set-up / Verband		
			m <sup>3</sup> /h	l/sec			Spacing Regnerabstand	Surface Fläche	Precipitation rate Regenhöhe	Spacing Regnerabstand	Surface Fläche	Precipitation rate Regenhöhe
mm	bar	m			m <sup>2</sup>	mm/h	max. m	m <sup>2</sup>	mm/h	max. m	m <sup>2</sup>	mm/h
4,5	2,0	13,8	1,05	0,29	598	1,76	20,7/23,9	494	2,12	19,5	380	2,76
	2,5	14,8	1,18	0,33	688	1,71	22,2/25,6	569	2,07	20,9	438	2,69
	3,0	15,7	1,29	0,36	774	1,67	23,5/27,2	640	2,01	22,2	493	2,62
	3,5	16,5	1,40	0,39	855	1,64	24,7/28,6	707	1,98	23,3	544	2,57
	4,5	17,8	1,58	0,44	995	1,59	26,7/30,8	823	1,92	25,1	633	2,49
5,0	2,0	14,2	1,30	0,36	633	2,05	21,3/24,6	524	2,48	20,1	403	3,22
	2,5	15,3	1,46	0,40	735	1,99	22,9/26,5	608	2,40	21,6	468	3,12
	3,0	16,2	1,59	0,44	824	1,93	24,3/28,0	681	2,33	22,9	524	3,03
	3,5	17,0	1,72	0,48	908	1,89	25,5/29,4	750	2,29	24,0	578	2,97
	4,5	18,4	1,95	0,54	1063	1,83	27,6/31,8	879	2,22	26,0	677	2,88
5,5	2,0	14,7	1,58	0,44	678	2,33	22,0/25,4	561	2,81	20,8	432	3,66
	2,5	15,7	1,76	0,49	774	2,27	23,5/27,2	640	2,75	22,2	492	3,57
	3,0	16,7	1,93	0,54	876	2,20	25,0/28,9	724	2,66	23,6	557	3,46
	3,5	17,5	2,08	0,58	962	2,16	26,2/30,3	795	2,61	24,7	612	3,40
	4,5	19,0	2,36	0,66	1134	2,08	28,5/32,9	938	2,52	26,8	722	3,27
6,0	2,0	15,0	1,88	0,52	706	2,66	22,5/26,0	584	3,22	21,2	449	4,18
	2,5	16,2	2,10	0,58	824	2,55	24,3/28,0	682	3,08	22,9	524	4,00
	3,0	17,1	2,30	0,64	918	2,50	25,6/29,6	759	3,03	24,1	584	3,93
	3,5	18,0	2,48	0,69	1017	2,44	27,0/31,1	841	2,95	25,4	647	3,83
	4,5	19,5	2,81	0,78	1194	2,35	29,2/33,7	988	2,84	27,6	760	3,70
6,5	2,0	15,4	2,20	0,61	745	2,95	23,1/26,6	616	3,57	21,8	474	4,64
	2,5	16,5	2,46	0,68	855	2,88	24,7/28,5	707	3,48	23,3	544	4,52
	3,0	17,5	2,70	0,75	962	2,81	26,2/30,3	795	3,39	24,7	612	4,41
	3,5	18,4	2,91	0,81	1063	2,74	27,6/31,8	879	3,31	26,0	677	4,30
	4,5	20,0	3,30	0,92	1256	2,63	30,0/34,6	1039	3,18	28,2	799	4,13
7,0	2,0	15,7	2,55	0,71	774	3,29	23,5/27,2	640	3,98	22,2	493	5,17
	2,5	16,9	2,85	0,79	897	3,18	25,3/29,2	742	3,84	23,9	571	4,99
	3,0	17,9	3,13	0,87	1006	3,11	26,8/31,0	832	3,76	25,3	640	4,88
	3,5	18,8	3,38	0,94	1110	3,04	28,2/32,5	918	3,68	26,6	707	4,78
	4,5	20,4	3,83	1,06	1307	2,93	30,6/35,3	1081	3,54	28,8	832	4,60
8,0	2,0	16,3	3,33	0,93	834	3,99	24,4/28,2	690	4,82	23,0	531	6,27
	2,5	17,5	3,73	1,04	962	3,88	26,2/30,3	795	4,69	24,7	612	6,09
	3,0	18,6	4,08	1,13	1087	3,75	27,9/32,2	899	4,54	26,3	692	5,90
	3,5	19,5	4,41	1,23	1194	3,69	29,2/33,7	987	4,46	27,5	760	5,80
	4,5	21,2	5,00	1,39	1411	3,54	31,8/36,7	1167	4,28	30,0	900	5,56

N.B.: The performance data were obtained under ideal testing conditions and may be adversely affected by wind and other factors. Pressure refers to pressure at nozzle. Consider wind speed and wind direction when designing an irrigation system. Reduce the spacing for the selected sprinkler set-up accordingly. Die in der Tabelle angegebenen Daten beziehen sich auf Windstille und können durch Windeinfluss oder andere Faktoren negativ beeinflusst werden. Der angegebene Betriebsdruck bezieht sich auf den Druck an der Düse. Bei Auslegung von Beregnungsanlagen sind Windrichtung und Windgeschwindigkeit zu berücksichtigen. Die Regnerabstände sind im Verband entsprechend zu verringern.

# komet | Sprinkler F41/2

Dimensions / Abmessungen

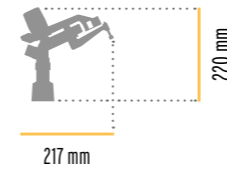

Nozzle Düse A / B	Pressure Druck	Throw Wurf- weite	Flow / Durchfluss		Surface Fläche	Precipitation rate Regenhöhe	▲ Set-up / Verband			■ Set-up / Verband		
			m <sup>3</sup> /h	l/sec			Spacing Regnerabstand	Surface Fläche	Precipitation rate Regenhöhe	Spacing Regnerabstand	Surface Fläche	Precipitation rate Regenhöhe
mm	bar	m			m <sup>2</sup>	mm/h	max. m	m <sup>2</sup>	mm/h	max. m	m <sup>2</sup>	mm/h
4,5 x 3,2	2,0	13,8	1,62	0,45	598	2,71	20,7/23,9	495	3,27	19,5	381	4,25
	2,5	14,8	1,81	0,50	688	2,63	22,2/25,6	569	3,18	20,9	438	4,13
	3,0	15,7	1,99	0,55	774	2,57	23,5/27,2	640	3,11	22,2	493	4,04
	3,5	16,5	2,14	0,60	855	2,50	24,7/28,6	707	3,03	23,3	544	3,93
	4,5	17,8	2,43	0,68	995	2,44	26,7/30,8	823	2,95	25,1	633	3,83
5,0 x 3,2	2,0	14,2	1,84	0,51	633	2,90	21,3/24,6	524	3,51	20,1	404	4,56
	2,5	15,3	2,05	0,57	735	2,79	22,9/26,5	608	3,37	21,6	468	4,38
	3,0	16,2	2,25	0,62	824	2,73	24,3/28,0	682	3,30	22,9	525	4,29
	3,5	17,0	2,43	0,67	908	2,68	25,5/29,4	750	3,24	24,0	578	4,20
	4,5	18,4	2,75	0,76	1063	2,59	27,6/31,8	879	3,13	26,0	677	4,06
5,5 x 3,2	2,0	14,7	2,11	0,59	678	3,11	22,0/25,4	561	3,76	20,8	433	4,88
	2,5	15,7	2,36	0,65	774	3,05	23,5/27,2	640	3,69	22,2	493	4,79
	3,0	16,7	2,58	0,72	876	2,94	25,0/28,9	724	3,56	23,6	558	4,63
	3,5	17,5	2,79	0,77	962	2,90	26,2/30,3	795	3,51	24,7	612	4,56
	4,5	19,0	3,16	0,88	1134	2,79	28,5/32,9	938	3,37	25,8	722	4,38
6,0 x 3,2	2,0	15,0	2,41	0,67	706	3,41	22,5/26,0	584	4,12	21,2	450	5,36
	2,5	16,2	2,69	0,75	824	3,26	24,3/28,0	682	3,95	22,9	525	5,13
	3,0	17,1	2,95	0,82	918	3,21	25,6/29,6	759	3,88	24,1	584	5,04
	3,5	18,0	3,19	0,89	1017	3,13	27,0/31,1	841	3,79	25,4	648	4,92
	4,5	19,5	3,61	1,00	1194	3,02	29,2/33,7	988	3,65	27,6	760	4,75
6,5 x 3,2	2,0	15,4	2,73	0,76	745	3,66	23,1/26,6	616	4,43	21,8	474	5,76
	2,5	16,5	3,06	0,85	855	3,58	24,7/28,5	707	4,33	23,3	544	5,62
	3,0	17,5	3,35	0,93	962	3,48	26,2/30,3	795	4,21	24,7	612	5,47
	3,5	18,4	3,62	1,00	1063	3,40	27,6/31,8	879	4,12	26,0	677	5,35
	4,5	20,0	4,10	1,14	1256	3,26	30,0/34,6	1039	3,95	28,3	800	5,13
7,0 x 3,2	2,0	15,7	3,09	0,86	774	3,99	23,5/27,2	640	4,83	22,2	492	6,27
	2,5	16,9	3,45	0,96	897	3,84	25,3/29,2	742	4,65	23,9	571	6,04
	3,0	17,9	3,78	1,05	1006	3,76	26,8/31,0	832	4,54	25,3	641	5,90
	3,5	18,8	4,08	1,13	1110	3,67	28,2/32,5	918	4,44	26,6	707	5,77
	4,5	20,4	4,63	1,29	1307	3,54	30,6/35,3	1081	4,28	28,8	832	5,56
8,0 x 3,2	2,0	16,3	3,87	1,07	834	4,64	24,4/28,2	690	5,61	23,0	530	7,28
	2,5	17,5	4,32	1,20	962	4,49	26,2/30,3	795	5,43	24,7	612	7,05
	3,0	18,6	4,74	1,32	1087	4,36	27,9/32,2	899	5,27	26,3	692	6,85
	3,5	19,5	5,12	1,42	1194	4,29	29,2/33,7	987	5,18	27,5	760	6,73
	4,5	21,2	5,80	1,61	1411	4,11	31,8/36,7	1167	4,97	29,9	899	6,45

N.B.: The performance data were obtained under ideal testing conditions and may be adversely affected by wind and other factors. Pressure refers to pressure at nozzle. Consider wind speed and wind direction when designing an irrigation system. Reduce the spacing for the selected sprinkler set-up accordingly. Die in der Tabelle angegebenen Daten beziehen sich auf Windstille und können durch Windeinfluss oder andere Faktoren negativ beeinflusst werden. Der angegebene Betriebsdruck bezieht sich auf den Druck an der Düse. Bei Auslegung von Beregnungsanlagen sind Windrichtung und Windgeschwindigkeit zu berücksichtigen. Die Regnerabstände sind im Verband entsprechend zu verringern.

## Charts and hints

### 1) Average daily watering requirements

- cold and humid climate	2,5 mm = l/sec per hectare 0,29
- cold and dry climate	3,8 mm = l/sec per hectare 0,44
- moderate and humid climate	3,8 mm = l/sec per hectare 0,44
- moderate and dry climate	5,1 mm = l/sec per hectare 0,59
- hot and humid climate	5,1 mm = l/sec per hectare 0,59
- hot and dry climate	7,6 mm = l/sec per hectare 0,88

### 2) Intake rates of various soils per hour (level ground)

- sand	19-25 mm/hour
- loamy sand	12-19 mm/hour
- sandy loam	up to 12 mm/hour
- loam	up to 10 mm/hour
- silt	up to 8 mm/hour

### 3) Slope precipitation table

Grade of slope	Precipitation rate reduction
0 - 5%	0%
6 - 8%	20%
9 - 12%	40%
13 - 20%	60%
over 20%	75%

### 4) Wind and sprinkler spacing

Wind is a very crucial factor in irrigation and wind speed and direction have to be taken into account when determining the spacing of sprinklers. Throws in the charts are based on conditions assuming the absence of wind, which is the exception in real life. Maximum spacings between sprinklers and between laterals have to be reduced according to wind speed.

It is suggested for example:

Average wind speed		Reduction factor (throw)	SETUP ■		SETUP ▲	
km/h	m/sec		spacing between sprinklers	spacing between laterals	spacing between sprinklers	spacing between laterals
0 - 3	0,85	0,90	1,25 R*	1,30 R	1,60 R	1,35 R
3 - 7	0,85 - 2	0,85	1,20 R	1,20 R	1,50 R	1,30 R
7 - 10	2 - 3	0,80	1,10 R	1,20 R	1,40 R	1,20 R
over 10	over 3	0,70	1,00 R	1,10 R	1,20 R	1,10 R

\* R (Radius) = distance of throw

### 5) Determination of the required water supply

$$q = qs \times F \frac{24}{h}$$

where:

q = Water requirements in l/sec  
 qs = specific water requirements in l/sec/ha (as under pt. 1)  
 F = Area to be irrigated in ha  
 h = hours of irrigation per day

### 6) Selection of set-up and sprinkler spacing

a) Square or rectangular set-up is preferred for movable systems. In the absence of wind the maximum theoretical sprinkler spacing can be calculated as follows:

$$L = \sqrt{2} R$$

where:

L = Length of square in m = sprinkler spacing  
 R = Radius = distance of throw in m can be obtained from the charts.

*IMPORTANT: reduce spacing according to average prevailing wind speed (as under pt. 4)*

b) Triangular setup is preferred in solid set systems and for frost protection systems. In the absence of wind maximum spacing can be calculated as follows:

Between sprinklers  $L_1 = \sqrt{3} R$   
 Between laterals  $L_2 = 1,5 R$

The irrigated area F covered by any chosen setup is calculated as follows:  
 $F = L_1 \times L_2$

*IMPORTANT: reduce spacing according to average prevailing wind speed (as under pt. 4)*

### 7) Precipitation

Precipitation is the amount of water applied evenly to a certain area within 1 hour measured in mm/hour and is calculated as follows:

$$i = \frac{q \times 1000}{L_1 \times L_2}$$

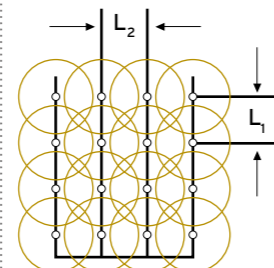

where:  
 q = discharge of sprinkler in m³/h  
 i = precipitation in mm/h  
 This formula applies to any setup ▲ and ■

*IMPORTANT: i should not be higher than the intake rate of the prevailing soil corrected for any existing slope (see point 2 and 3).*

### 8) Running time of irrigation equipment

Running time necessary to apply the desired precipitation rate is calculated as follows:

$$T = \frac{H}{i}$$

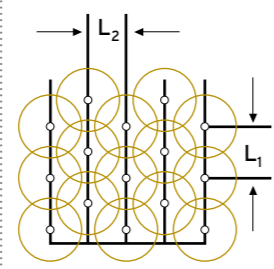

where:  
 T = running time in hours  
 H = desired precipitation rate in mm  
 i = precipitation rate in mm/h

*An easy evaluation of the irrigated area and the precipitation rate as a result of reduced spacings due to wind can be done using the factors in this table. The performance data of the sprinklers refer to no wind condition.*

wind speed km/h	% reduction of ▲ and ■ spacing	% reduction of covered area	% increase precipitation rate
0 - 3	- 8%	- 16%	+ 16%
3 - 7	- 14%	- 28%	+ 28%
7 - 10	- 20%	- 40%	+ 40%
over 10	- 30%	- 60%	+ 60%

**NOTE:** Information given on this page is based on average conditions and given for the purpose of orientation and to show examples of the most common variations of conditions and their qualitative influence on irrigation. Any data given are deemed reliable but not guaranteed.

## Technische Hinweise

### 1) Täglicher Wasserbedarf, Durchschnittswerte

- kaltes und feuchtes Klima	2,5 mm = l/sec pro ha 0,29
- kaltes und trockenes Klima	3,8 mm = l/sec pro ha 0,44
- gemäßigtes und feuchtes Klima	3,8 mm = l/sec pro ha 0,44
- gemäßigtes und trockenes Klima	5,1 mm = l/sec pro ha 0,59
- warmes und feuchtes Klima	5,1 mm = l/sec pro ha 0,59
- warmes und trockenes Klima	7,6 mm = l/sec pro ha 0,88

### 2) Wasseraufnahmevermögen des Bodens

- Sand	19-25 mm/h
- lehmiger Sand	12-19 mm/h
- sandiger Lehm	bis 12 mm/h
- Lehm	bis 10 mm/h
- Ton	bis 8 mm/h

### 3) Einfluss der Hangneigung

Hangneigung	Verminderung der Wasseraufnahmefähigkeit des Bodens
0 - 5%	0%
6 - 8%	20%
9 - 12%	40%
13 - 20%	60%
über 20%	75%

### 4) Windeinfluss

Wind ist bekanntlich der größte Störfaktor in der Berechnung, er ist durch zweckmäßige Reduzierung der Regnerabstände im Verband unbedingt zu berücksichtigen. Absolute Windstille wie sie den Tabellen zu Grunde liegt, ist ein Ausnahmefall, es ist deshalb bei der Auslegung jeder Anlage der Einfluss des Windes mit seiner Richtung und Geschwindigkeit unbedingt entsprechend zu berücksichtigen. Man verwendet hierzu einen proportional der Windgeschwindigkeit entsprechenden Verringerungskoeffizienten.

Man empfiehlt z.B.:

Windgeschwindigkeit		Verringerungskoeffizient	■ VERBAND		▲ VERBAND	
km/h	m/sec		Abstand auf Leitung	Ab. zwischen Leitungen	Abstand auf Leitung	Ab. zwischen Leitungen
0 - 3	0,85	0,90	1,25 R*	1,30 R	1,60 R	1,35 R
3 - 7	0,85 - 2	0,85	1,20 R	1,20 R	1,50 R	1,30 R
7 - 10	2 - 3	0,80	1,10 R	1,20 R	1,40 R	1,20 R
über 10	über 3	0,70	1,00 R	1,10 R	1,20 R	1,10 R

\* R = Wurfweite

### 5) Ermittlung des Wasserbedarfs

$$q = qs \times F \frac{24}{h}$$

wobei:

q = Wasserverbrauch in l/sec  
 qs = spezifischer Wasserverbrauch in l/sec/ha (siehe Pkt. 1)  
 F = zu berechnende Fläche in ha  
 h = Stunden pro Tag

### 6) Auswahl eines Verbandes und Ermittlung der Regnerabstände

a) Viereck- oder Rechteckverband wird bei beweglichen Anlagen bevorzugt.

Bei Windstille ist der maximale, theoretische Regnerabstand:

$$L = \sqrt{2} R$$

wobei:

L = Seitenlänge des Vierecks in m  
 R = Wurfweite des Regners in m

Die Werte für R werden den Tabellen entnommen.

*WICHTIG: nicht vergessen, die Windverhältnisse zu berücksichtigen (siehe Pkt. 4)*

b) Dreieck-Verband wird bei stationären und bei Frostschutzanlagen bevorzugt.

Bei Windstille sind die maximalen, theoretischen Regnerabstände:

$$\text{auf der Leitung: } L_1 = \sqrt{3} R$$

$$\text{zwischen den Leitungen: } L_2 = 1,5 R$$

Die berechnete Fläche F jeder X-beliebigen Regneraufstellung errechnet sich aus dem Produkt des Regnerabstandes auf der Leitung und des Regnerabstandes zwischen den Leitungen:

$$F = L_1 \times L_2$$

*WICHTIG: nicht vergessen, die Windverhältnisse zu berücksichtigen.*

### 7) Niederschlagshöhe

Die Niederschlagshöhe ist die auf eine Fläche in einer Stunde entfallende Regenmenge in mm/h.

Sie errechnet sich:

$$i = \frac{q \times 1000}{L_1 \times L_2}$$

wobei:

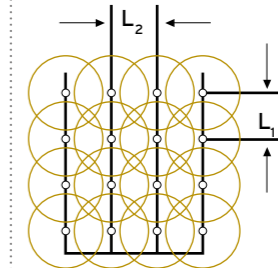

q = Wasserverbrauch eines Regners in m³/h  
 i = Niederschlagshöhe in mm/h  
 Diese Formel gilt für jede Art von Aufstellung, sei es ▲ - oder ■ - Verband

*WICHTIG: Der Wert der Niederschlagshöhe soll die Werte der Wasseraufnahmefähigkeit des Bodens, auch Hanglagen berücksichtigen, nicht überschreiten. (siehe Pkt. 2 und 3)*

### 8) Einschaltdauer der Anlage

$$T = \frac{H}{i}$$

wobei:

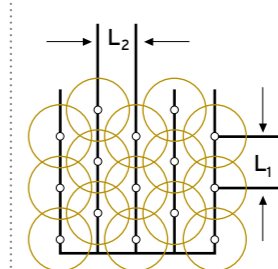

T = Einschaltdauer in h  
 H = gewünschte Niederschlagshöhe in mm  
 i = Niederschlagshöhe in mm/h

*Die einfache und schnelle Ermittlung der berechneten Fläche und der Niederschlagshöhe in Abhängigkeit der Windgeschwindigkeit, kann man aus der untenstehenden Tabelle ersehen. Grundlage hierfür sind die, in den einzelnen Tabellen angegebenen Werte, welche den Einfluss des Windes nicht berücksichtigen. Um eine Flächendeckung auch bei Wind zu haben, ist deshalb dessen Einfluss unbedingt zu berücksichtigen.*

Wind km/h	Regnerabstand im ▲ u. ■ reduzieren um m in %	Berechnete Fläche im ▲ u. ■ vermindert sich um:	Niederschlagshöhe erhöht sich im ▲ u. ■ um:
0 - 3	- 8%	- 16%	+ 16%
3 - 7	- 14%	- 28%	+ 28%
7 - 10	- 20%	- 40%	+ 40%
über 10	- 30%	- 60%	+ 60%

**N.B.:** Die technischen Daten auf diesem Blatt sind allgemeine Erfahrungswerte, welche durch besondere Gegebenheiten, Veränderungen unterworfen sind. Alle Angaben haben informativen Charakter, deshalb ohne Gewähr.



## Limited warranty and disclaimer

The following constitutes the full and complete limited warranty provided by Komet Austria GmbH ("Komet") in relation to its products. This limited warranty is in lieu of any and all other warranties, express or implied, including, but not limited to, any implied warranties of merchantability or fitness for particular purposes. No person or entity is authorized to incur or assume for Komet any other expense, obligation or duty as to products designed, manufactured and/or distributed by Komet.

So long as they are used under normal working conditions and in compliance with the manufacturer's working specifications and maintenance instructions, all products distributed by Komet are warranted to be free of defects in material and workmanship for a period of one year from the date of the product's original shipment. Normal wear and tear arising from operation, damages due to improper or inadequate maintenance and damages due to presence of sand or mud and due to oxidation or any other chemical processes are specifically excluded from this limited

warranty. This limited warranty does not apply to any product that has been altered in any way. Komet undertakes, at its unquestionable judgement, to replace or repair free of charge those parts of the apparatus that proved to be faulty, providing that they are returned shipping charges prepaid. The exclusive and sole remedy with respect to above provisions is expressly limited to the repair or replacement of the part deemed to be faulty. Komet shall not be liable for any crop damages, any direct, consequential or incidental damages to persons or things resulting from any use of Komet's products.

Komet reserves the right, at any time without notice, to alter or modify its products if deemed appropriate or necessary. Illustrations and instructions are for information purposes only and are not binding in any way. Any variations to the above provisions shall be accepted only if defined and confirmed in writing by Komet. In case a legal dispute should arise, the place of jurisdiction is the Court of Lienz/Austria.







**Komet Austria GmbH**

Julius Durst Str. 10  
9900 Lienz/Austria  
Ph. (+43) 4852 71550 500  
Fax. (+43) 4852 71550 550  
komet@kometirrigation.com  
www.kometirrigation.com

Rif. 381 ED. Z16/07 - ...

© Copyright 2016 Komet Austria GmbH

All data, indications and illustrations are only informative and are subject to change at any time without previous notice and without incurring obligation. Alle Angaben und Abbildungen in diesem Prospekt haben informativen Charakter. Änderungen jederzeit ohne Voranmeldung vorbehalten.





**ATTACHMENT 2**

**SNOWMAKING SYSTEMS AND EQUIPMENT**

**FOR MORE INFORMATION:**

<https://www.technoalpin.com/en/>



WASTEWATER SNOWMAKING



SNOWMAKING EQUIPMENT



# SMI GRIZZLY STICK

The Grizzly is SMI's newest low energy stick and an excellent performer in all temperature conditions.

Utilizing SMI's custom 5 jet nucleation technology and angled head design, the Grizzly creates extra hangtime and powerful throw, creating better snow quality for your conditions.

The Grizzly's 4 step water adjustment is simple and easy to use with SMI's Revolver Valve on manual equipment or an intelligent automatic valve at the tail of the stick.

The Grizzly also comes with an easy to access water filter and pressure gauge. Air and water flows are customized for your resort and configured based on your local weather and snowmaking goals.

The Grizzly is simple to operate, maintain and an excellent performer. A great addition to your LowE fleet. Contact your local SMI Representative for more information.



# GRIZZLY STICK HIGHLIGHTS

## 1. HEAD

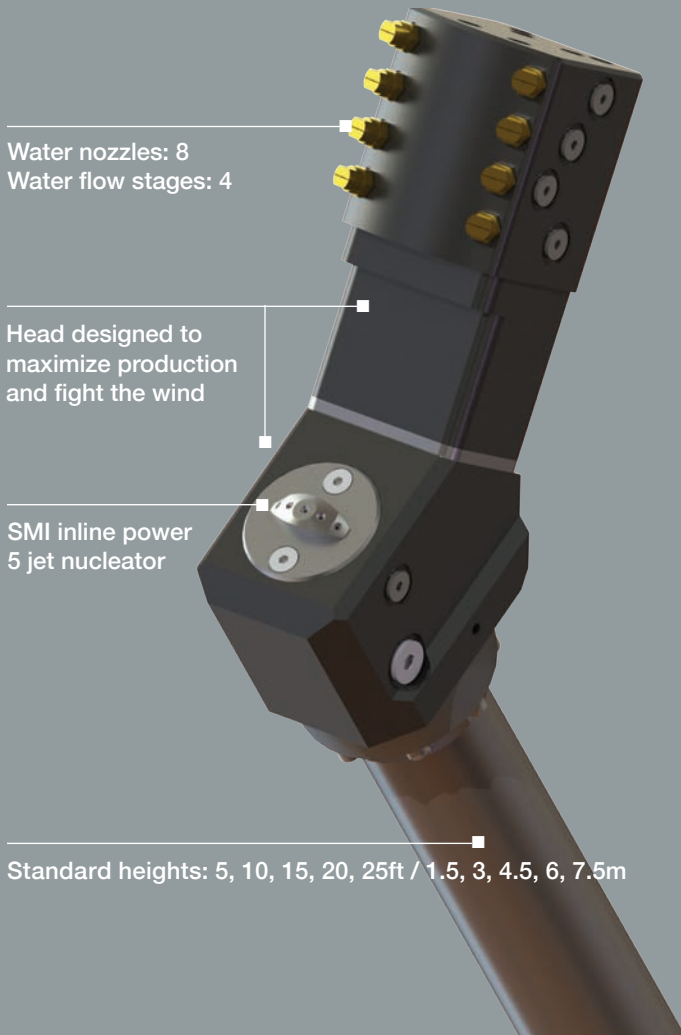

Water nozzles: 8  
Water flow stages: 4

Head designed to maximize production and fight the wind

SMI inline power 5 jet nucleator

Standard heights: 5, 10, 15, 20, 25ft / 1.5, 3, 4.5, 6, 7.5m

## 2. MANUAL REVOLVER VALVE

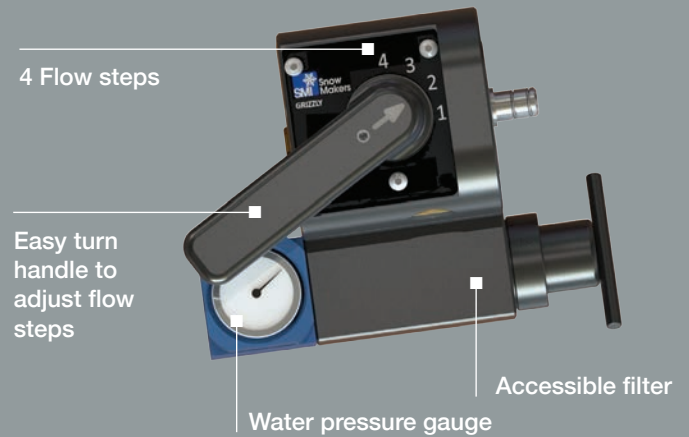

4 Flow steps

Easy turn handle to adjust flow steps

Water pressure gauge

Accessible filter

## 3. AUTO VALVE OPTIONS

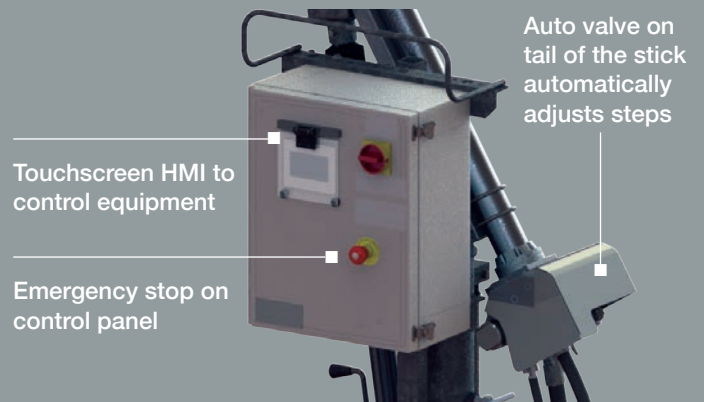

Touchscreen HMI to control equipment

Emergency stop on control panel

Auto valve on tail of the stick automatically adjusts steps

## CONFIGURATION OPTIONS

- Mounts: Base tube, vault, sled, 2-wheel cart
- Air: Hill Air (CFM Range from 8 to 120 CFM/ 226 to 3,400 LPM) or On-Board Compressor
- Controls: Manual or Automated

## AUTO HYDRANT ACTUATOR OPTIONS

- Hydrant Actuator for above ground hydrant. SMI automated pit valve for vault.
- Communication options: standalone, hardwire or radio
- Optional onboard weather
- Optional SmartSnow integration

Snow Machines, Inc. 1512 North Rockwell Dr. Midland, MI 48642 Tel: +1-989-631-6091 Toll Free: +1-800-248-6600 snowmakers.com



# TECHNICAL SPECIFICATIONS

- 10.5' (3.2 m) and 15.5' (4.5m) towers or 3-wheel galvanized carriage, and 25' (8 m) swing arm
- Electrical: 3-phase
- Super Puma Fan: 25 HP (19 Kw)  
Standard Puma Fan: 15 to 20 HP (11-15 Kw)  
Propeller: SMI custom aluminum  
Screen: stainless steel
- Compressor: 5 or 10 HP (4 or 7.5 Kw) Rotary Vane
- Heating: 500 to 2,500 Watts
- Water Flow: 10-130 gpm (40-500 lpm)
- Water Pressure: 150-1000 psi (10-63 Bar)
- Water Connection: Customer choice
- Valves: Five self draining heated 3-way valves
- Nucleators: Periphery with 27 nozzles
- Filtration System: Stainless steel filter with washable 30 mesh screen
- Electrical Cord: Tower 30' (10 m)  
Carriage 100' (30 m)
- Rotation: 360° horizontal rotation, -10° to 60° elevation adjustment
- Oscillator: Included as standard for 359° rotation with programmable arcs



Snow Machines, Inc.  
512 North Rockwell Dr.  
Midland, MI 48642  
USA Toll free: +1.800.248.6600  
International: +1.989.631.6091  
snowmakers.com

# PUMA

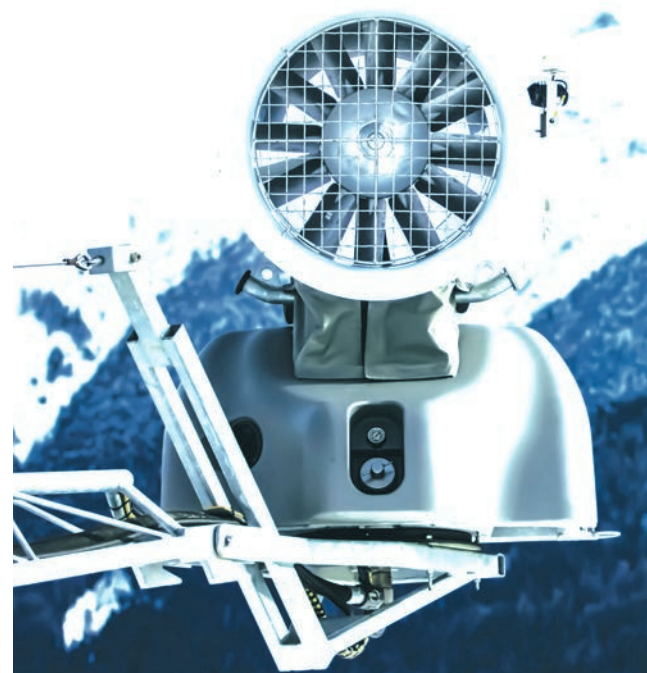



# king of the mountain



## THE PUMA SERIES

The Puma and Super Puma Snowmakers have been developed with input from customers, service technicians and sales reps, worldwide, with a goal of maximizing production over a wide range of conditions, especially in marginal temperatures. The Puma was designed to interface with automation and control software for optimum performance in any snowmaking weather. It is equipped with an on-board aspirated weather station, air and water pressure monitoring, and automated flow control. The small flow steps deliver a smooth snowmaking curve, fine-tuning the water volume, air pressure and nucleation to best suit constantly changing weather conditions.

Each unit employs a convenient touch-screen panel at eye level for manual control when desired, and the Puma can be configured to communicate with a central computer via hardwire (copper, CAT 5 Ethernet or fiber optic), or by radio. The machine is well-suited to central intelligence (a single computer or control room for all snowguns) or distributed intelligence

(some type of computer to manage each snowgun, pod or ski trail).

Thanks to the Puma's level of automation, operators can raise and lower the barrel or adjust the oscillation arc up to 359° on any number of machines from a central command station, helping to deliver pinpoint control with minimal labor. The result is better snow distribution and reduced man hours needed for grooming.

With its low, compact center of gravity and ergonomic design, the Puma is easy to use and transport. Components are positioned to make transport via snow cat blade easy and safe, minimizing overhanging load and reducing stress on the blade. Adjustable lifting brackets accommodate all snow cat blade designs.

Like all of SMI's products, the Puma follows a philosophy of easy operation, transport and maintenance. The units are designed to be user serviceable, with readily available replacement parts.

SMI's ultimate goal is to provide equipment that allows ski resorts to open earlier in the season, with higher trail counts. The rising levels of automation in designs like the Puma help achieve that goal, and to recover more quickly from bad weather events, so you can stay open longer and offer the best snow surfaces possible.





# SMI V2 SNOWTOWER™

The low energy V2 is designed for versatility and flexible performance across a full range of temperature and wind conditions. The V2 is a four step (2 valves) stick with 12 nozzles and 2 nucleators.

Features of the V2 include: mounts in post for hill or vault, and in portable sled; on board compressor and central air feed options; light weight compo-

nents that feature tool less fasteners for easy portability; easy lift off compressor and control panel; 15 to 25 foot (4.5 to 7.5 meter) mast lengths; manual, semi automatic and fully automated options; automated on board or central weather options; and nucleator air flow ranges from 20 to 140 cfm (0.6 to 4.0 cmm).

The V2 is well packaged and simple to install and operate. The custom nucle-

ation and filter system are easy to maintain. The jack for raising and lowering the V2 is safe and easy to operate. The optional automatic valving system is a custom design that allows the extra water to simply adjust to the changing temperatures.

Call SMI or your local representative today for more information or visit us at [snowmakers.com](http://snowmakers.com).



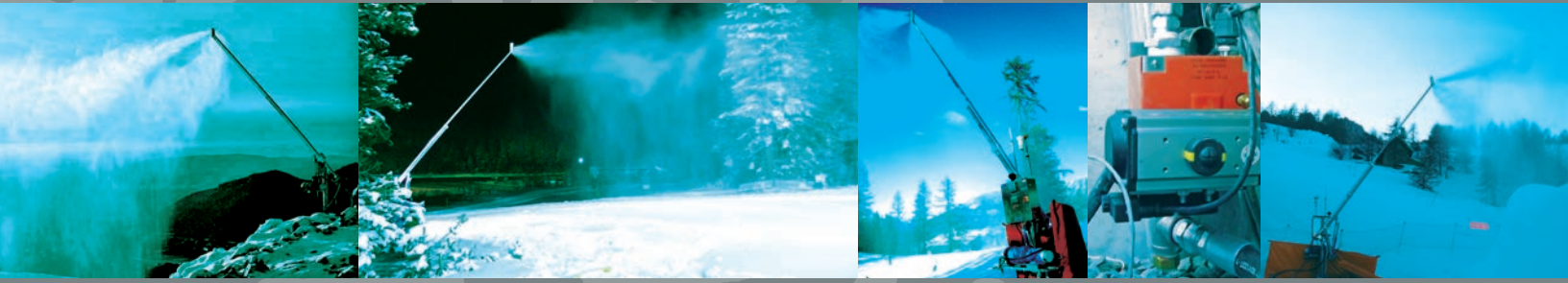

# TECHNICAL SPECIFICATIONS

## V2 FLEXIBILITY AND PERFORMANCE

The V2 SnowTower™ has many flexible automation options including remote control and full automatic modes of operation for individual standalone machines or when connected to a complete network.

SMI's SmartSnow™ Automation & Control software is flexible and customizable and offers proven communication options, accurate weather measurement, supporting equipment and instrumentation, integrated auxiliary equipment, and service that is second to none.



This low energy air / water stick relies on the shared accessories available in the Viking product family such as:

- i) Common vault – for direct mounting of stick (Optional covered and heated concrete vault provides base tube mounting, electrical, water, air (optional), and communication (optional) connection ports)
- ii) Common base assembly
- iii) Easy lift off components
- iv) Removable jack

- Approximate overall height: 20' (6 m) or 30' (9 m)
- Water nozzles: 12 nozzles
- Nucleation nozzles: 2 nozzles
- Air supply: minimum 20 cfm (0.57 m3/min) for hill air
- Jack: removable hydraulic with safety latch
- Boom and head assembly: aluminum
- Tower and base: galvanized steel
- Operating water pressure range: 250-870 psi (17 - 60 bar)
- Feed-through tower assembly for clean appearance
- Mount: post, vault or sled



Snow Machines, Inc.  
 1512 North Rockwell Dr.  
 Midland, MI 48642  
 Tel: +1-989-631-6091  
 Toll Free: +1-800-248-6600  
 snowmakers.com

**ATTACHMENT 3**

**CASE STUDY: CARRABASSETT, MAINE WASTEWATER DISPOSAL  
THROUGH SPRAY IRRIGATION AND SNOWMAKING**





# LAGOON SYSTEMS IN MAINE

An Informational Resource for Operators of Lagoon Systems



[Mission](#) | [Search](#) | [Acknowledgements](#) | [Discussion Group](#) | [Contact Us](#) | [Links](#)



## Carrabassett Valley Sanitary District Carrabassett Valley, Maine



[Design & Operation](#)

[Lagoon Aeration](#)

[Tech Papers](#)

[Operation Articles](#)

[Lagoons In Maine](#)

[The Laboratory](#)

[Maine Lagoon News](#)

[Lagoon Biology](#)

[Resources](#)

[Biosolids](#)

**new**  
[2003 Maine Wastewater Salary Survey as conducted by the Maine Wastewater Control Association](#)

**new**  
[2003 Maine Wastewater Rate Survey conducted by the Maine Rural Water Association](#)

**Carrabassett Valley, Maine**, well known for some of the best skiing in the Northeast, has placed itself on the map for another reason. Its wastewater authority has successfully put in place the first permanent system of its kind in the world to treat and **dispose of wastewater by spraying effluent into snow**.



CVSD Snowfields

The **Carrabassett Valley Sanitary District** serves approximately 900 living units plus the commercial facilities, the equivalent of about 6,000 people. The 7 lagoons are earthen-berm construction with clay lining. The aerated lagoon and each of the initial three storage lagoons are designed to hold 5.2 million gallons of sewage. Each backup lagoon is designed to hold 5.8 million gallons, giving a total volume of thirty-eight million gallons of which 33 million gallons is storage. The treated effluent is then pumped to a land-based disposal system comprised of a slow rate sprinkler irrigation system and freeze nucleation (snowmaking).

The spray irrigation system is designed to empty the contents of the lagoons plus the associated summer wastewater flow and precipitation.



[Maine DEP Monthly O & M Newsletter](#)

[Maine and WEF's Operation Forum](#)

[Penobscot Watershed and Development of a TMDL](#)

[EPA Binational Toxics Strategy](#)

[Maine Rural Water Association](#)

[Maine Wastewater Operator Certification Guide](#)

[Maine Is Technology Newsletter](#)

[Maine Wastewater Control Association](#)



[Maine Wastewater Engineering Firms](#)



Two 125 horsepower vertical turbine pumps (300 gpm each) deliver effluent to the snow making towers

Effluent is pumped to a forested disposal site, separate from the snowmaking site, at fifty thousand gallons per acre per week.

Located in the western mountains of Maine, Carrabassett Valley has historically relied on spray irrigation for wastewater disposal of treated effluent during the summer. As

soon as the Carrabassett Valley Sanitary District (District) was organized in 1993 to provide wastewater disposal services for the Sugarloaf Mountain Ski Resort and surrounding area, the Board of Trustees faced a shortage of lagoon storage space. Although their community is small, it increases to more than 10,000 during ski season, and the lagoons were full to nearly overflowing by the time the spray season began. Before the concept of spraying effluent into snow was ever discussed, plans called for construction of as many as 54 lagoons at a cost of \$250,000 each and 26 spray irrigation areas, at a cost of \$150,000 to \$200,000 each, over 200 acres of wooded spray irrigation areas.

This construction would take place on the treatment site property, located several miles from the access road to the Sugarloaf Mountain Ski Resort to accommodate projected build-out of the sewerage area.



There are 2 two hundred horsepower air compressors capable of delivering 800 cfm @ 140 psi.

Never entirely satisfied that the lagoon construction plan was the best approach, sanitary district trustees went looking for an alternate strategy. A less costly and more practical approach to wastewater treatment and disposal by constructing snowmaking towers on the treatment site property instead of scores of lagoons was the new direction taken.

A decade of environmental hurdles was about to begin in Carrabassett Valley.

The primary stumbling block to be cleared was overcoming regulators' concerns about the fate of contaminants, surface runoff, and over saturation of the soil. Furthermore, without the Maine Department of Environmental Protection's blessing, financing sources were wary. Woodard

& Curran, selected as the newly organized Carrabassett Valley Sanitary District's engineer, analyzed the technology. This analysis turned out to be the critical step in allowing the project to move forward by explaining and resolving the issue of contaminant fate and transport. An explanation to Maine DEP why it worked by identifying the fundamental physical/chemical principles involved took place. This convinced them that making snow was, in fact, a viable treatment technology and cleared the way for license approval. The project has moved ahead smoothly ever since.



Snowmobile tracks cover the landscape. The machines are used by the operators to keep a watchful eye on the snowmaking process.

Snow is made out of lagoon effluent throughout the winter and is spread out over a cleared, prepared site. Melting and disposal into the ground take place over the spring and early summer. This approach significantly reduces the storage volume required by applying effluent to the fields over the winter, when the influx of people to the ski resort results in the District's highest flows. The process is intended as a disposal method primarily, although the lagoon effluent receives additional treatment by means of the freeze/thaw process.

Another key to the process is making snow as soon as freezing weather starts. This way the snow pack develops before the ground freezes. Then, in the spring, when warm weather starts the melting process, the treated effluent (melted water) infiltrates into the unfrozen ground with minimal runoff. It is not uncommon to see mounds of snow still melting in July.

After the systems first year of operation (28,000,000 gals. of effluent turned into snow), the District Trustees voted to increase the operational effectiveness by adding three additional snowmaking towers and a 750 kW diesel generator. This reduced the power costs from \$20,000 a month to \$18,000 annually (based upon costs of \$0.50 /gal. of diesel fuel).

The 1,000 horsepower generator powers 2 two hundred horsepower air compressors capable of delivering 800 cfm @ 140 psi. Two 125 horsepower vertical turbine pumps (300 gpm each) deliver effluent via buried 6-inch welded steel pipe to the eleven 40-foot high snowmaking towers. Normal snowmaking operations of 1,000 hours per year (42 days) are required to turn the stored lagoon effluent into man-made snow. Facility

Superintendent David Keith describes optimum snowmaking conditions as "cold and windy".

This two hundred and fifty thousand dollar (\$250K) upgrade improved the ability to more evenly distribute snow across the cleared application area and reduced operating costs by approximately fifty thousand dollars

(\$50K) annually with savings from in-house power generation and reduced site maintenance. Design, equipment purchases, and planning were performed in-house at a considerable savings.



District Superintendent Dave Keith checks the nozzles atop the snow gun tower



A view from the bottom

In 1997, CVSD recognized weaknesses in the snowmaking process control system. The Trustees approved a further expenditure from the remaining balance of construction funds to upgrade the snowmaking system from a PC based control system to a PC/PLC based I/O system. The revised system is SCADA technology that allows centrally based control, monitoring and reporting (operator interface software) at the main control building. This allowed communications locally to PLCs (processors and I/O with system programs) within the control building and with the facility's in-house power generation system, at the snowmaking distribution vault and the District's sewage pumping station. To further enhance the system, both the District Superintendent and Plant Operator have remote access and control of the operating system via home-based personal computers.

The addition of snowmaking technology has the potential to more than double the capacity of Carrabassett Valley's existing facilities without needing any additional storage lagoons and within the existing 60 acres of land application area. This



effluent disposal project has relieved the District's concerns for a long time to come.

**Carrabassett Valley Sanitary District - Operational Snap Shot  
In-House Three Phase Power Generation**

	Gallons Processed	Hours Operated	Gallons Hour	Fuel Usage Gallons	Fuel \$\$/Gal	KWH Generated	\$\$ KWH	\$\$/Gallon Snowmaking
Dec-99	3,234,562	100	32,546.6	3,994	0.50	53,230	0.0375	0.0006
Jan-00	6,939,425	202	34,353.6	8,298	0.50	108,033	0.0384	0.0006
Feb-00	2,666,652	79	33,755.1	3,292	0.50	42,116	0.0391	0.0006
Mar-00	581,246	15	38,749.7	579	0.50	8387	0.0345	0.0005
Dec-00	2,287,716	74	30,915.1	3,063	0.50	38,904	0.0394	0.0007
Jan-01	5,036,128	146	34,494.0	5,986	1.17	75,392	0.0929	0.0014
Feb-01	3,026,193	87	34,783.8	3,489	1.25	45,469	0.0959	0.0014
<b>Totals</b>		<b>703</b>		<b>28,701</b>				
		<b>Average</b>	<b>34,199.57</b>			<b>0.0540</b>		<b>\$0.00083</b>

**Lagoon Specifications**

Lagoons	No.1	No.2	No.3	No.4	Storage 1	Storage 1	Storage 1
Volume	5.2 MG	5.2 MG	5.2 MG	5.2 MG	5.8 MG	5.8 MG	5.8 MG
Aeration	Coarse Bubble	None	None	None	None	None	None

**Comments:** Lagoons operate at 9.0 feet of depth.  
Total lagoon area - 18 acres or 780,00 sq. ft.

**System Information**

Design Flow	Licensed to Discharge 40 MG/Year to Spray Irrigation and 56 MG/Year
Actual Flow	0.10 to 0.40 MGD (highest in winter)
Discharge To	Land Application



Year Built	1985
Design Engineers	James Sewall Co. Upgrade - Woodard and Curran
Septage Received	No
Collector System	12 miles gravity sewer, 1 pump station , 280 manholes
Staff Size	2 Full Time
Number of Users	Year round 100 users. Winter peaks to 4,000 people
Billing Software	Uses GIS for collection system maintenance

[Back to Lagoons in Maine](#)



## **EXHIBIT D**

EXHIBIT D

SPRAY IRRIGATION SYSTEMS AND EQUIPMENT

FOR MORE INFORMATION:

<https://www.kometirrigation.com/products/big-sprinkler/long-distance-sprinkler>



WASTEWATER SPRAY IRRIGATION SYSTEMS

## Nelson SR150 End Gun, Part Circle



SKU: SR150

Brand: [Nelson](#)

\$2177.32

Qty:

---

## Description

*Nelson SR150 End Gun, Part Circle is Valley, Lindsay/Zimmatic, Reinke, Pierce, Olson and Lockwood compatible.*

Nelson SR150 End Gun, Part Circle

150 Series Big Gun

The 150 Series is a perfect fit for solid set irrigation, traveler irrigation and dust suppression. Anodized, Powder Coated or Stainless Steel units are available, which makes this a great option for mining or wastewater applications.

The Nelson 150 Series Big Gun Part Circle (21 , 24 , 27 , 43 , or 15 -45 adjustable trajectory) sprinkler. Taper, Taper Ring, or Taper Bore Nozzles are available.





# **YUZUAK JET 35T 2" CLEAN/DIRTY WATER GEAR DRIVE RAIN GUN**

## **Item Information**

Condition:

Bulk savings:

2 or more for \$399.97/eaBuy 2 or more for 399.97 each one



INNOVATIVE  
IRRIGATION

## komet | *Sprinklers*

**Universal Sprinklers**  
for Solid-set Systems

**Universale Regner**  
für ortsfeste Anlagen



THE KOMET ADVANTAGE:  
INNOVATION WITH IMPACT



# komet | *Sprinklers*

While conceiving new products, we must make sure that they meet the values in which we strongly believe: quality, reliability and a solid advantage to the customer. The quality of a product is a reflection of what the people who create, manufacture and market it, stand for. This approach to our work is very important to us.

Reliability is achieved by using the most suitable and functional materials for the intended purpose as well as implementing the strictest quality controls in every step throughout the manufacturing process of our products. The advantage to the customer is found in our efforts to offer products of highest quality and reliability combined with innovative features that we implement in all of them.

The Komet Universal Sprinklers represent our capacity to integrate innovative technology, performance and reliability.

Ein neues Produkt spiegelt immer auch die Menschen, die an seiner Entwicklung und Herstellung beteiligt waren. Und die Überzeugungen, für welche diese Menschen stehen. Für uns sind das Werte wie Qualität, absolute Zuverlässigkeit und ein immanenter Vorteil für den Anwender. Für diesen Anspruch stehen wir ein. Wir glauben an das, was wir tun und vor allem daran, wie wir es tun.

Unser Qualitätsanspruch beginnt mit der Verwendung des besten Materials. Innovatives Ingenieurwissen fließt in die Konzeption und Erprobung neuer Produkte ein. Der Fertigungsprozess schließlich ist von engmaschigen Qualitätskontrollen begleitet und sichert so die Solidität und Langlebigkeit unserer Produkte. Die Komet Universal Regner sind das Ergebnis dieses perfekten Zusammenspiels von innovativer Technologie, Leistung und Zuverlässigkeit.



## Komet Philosophy

We are a family business. We inherited the values that are the foundation of our relationships from the company's founder Roland Drechsel, our father. For us, the order of the day is honesty, respect and trust. We believe that in today's world, rather than inventing new promises, it is far more important to respect, uphold and build on the customer promises that our company was founded on. In addition to providing the highest quality irrigation equipment, we want to make sure our customers have water application products that operate at the highest levels of efficiency and effectiveness, which in turn will help to limit the waste of our natural resources. We believe in building long lasting relationships with our customers. This gives us the opportunity to understand their needs, analyze how our products are meeting those needs, and to continue to improve. We believe in what we do, and are passionate about how we do it.

## Komet Philosophie

Wir sind ein Familienunternehmen. Und als solches fühlen wir uns den Werten und der Tradition, für die schon unser Vater Roland Drechsel als Unternehmensgründer eingestanden ist, weiterhin verpflichtet. Ehrlichkeit, Respekt und Vertrauen stehen für uns an erster Stelle. Für uns sind sie – auch und gerade in Zeiten des globalisierten Business – die Basis erfolgreicher Geschäftsbeziehungen. Dass ein gegebenes Versprechen eingehalten wird, dass Vereinbarungen für uns verbindlich sind – das erscheint uns heute wichtiger denn je. Als kompetenter und verlässlicher Partner helfen wir unseren Kunden, die optimale Beregnung zu gewährleisten – bei höchster Effizienz und maximaler Schonung der Ressourcen. Wir bemühen uns um langfristige und tragfähige Beziehungen zu unseren Kunden. Der intensive Austausch mit den Kunden und eine genaue Analyse der jeweiligen Rahmenbedingungen und Erfahrungen ermöglichen es uns, individuelle Lösungen anzubieten und bestehende Konzepte gegebenenfalls zu optimieren. Eine Vielzahl langjähriger Geschäftsbeziehungen spricht dafür, dass dieser Weg der richtige ist.



## Operating Cost

VS

## Purchase Cost

A trend has been developing in the past few years in which the purchase cost of a product has become the most important factor when purchasing equipment. This trend has changed the scope of many companies, moving to a short term market approach that focuses on the purchase cost instead of its real operating cost. We at Komet are firmly convinced that our customers generate greater benefit by optimizing the operating cost of the products they use. Our priorities when developing products are to make sure that they are the most reliable, always operate at the optimum efficiency, are easy to use and minimize the waste of precious natural resources. It is surely less demanding and more economically feasible to concentrate a company's product lines with the short term market approach, but we believe that the credibility of our brand is based on the long term quality and performance of our products, and more importantly the return on investment our customers can realize.

## Betriebskosten

VS

## Anschaffungskosten

Zu den Marktgesetzen der jüngeren Vergangenheit zählt es, dass die Anschaffungskosten eines Produktes im Vordergrund stehen. Das ist verständlich, steht einer nachhaltigen Kosten-Nutzen-Analyse aber oft im Weg. Gerade bei langlebigen Produkten wie unseren, die viele Jahre im Einsatz sind, entscheiden in erster Linie die Betriebskosten und die Wartungs- und Reparaturfrequenzen über die tatsächliche Rentabilität. Wir von Komet sind davon überzeugt, dass durch die Optimierung der Betriebskosten der eigentliche Mehrwert für den Kunden entsteht. Deshalb konzentrieren wir uns bei der Entwicklung unserer Produkte auf hohe Zuverlässigkeit, einfache Bedienbarkeit und eine optimale, Ressourcen schonende Effizienz. Etwas kostengünstigere Lösungen mögen auf den ersten Blick ökonomischer sein. Auf lange Sicht aber bewähren sich eben diese den individuellen Bedürfnissen angepassten Produkte, die sich durch hohe Qualität und Langlebigkeit und vergleichsweise geringe Betriebskosten auszeichnen. Auch dafür geben wir unser Wort.

# The Advantages / Die Vorteile

## 1.

### WATER DISTRIBUTION WASSERVERTEILUNG

Water distribution is a very important aspect in irrigation and therefore it is important to develop devices with improved performance levels. The Komet Sprinkler product line offers great performance with an excellent water distribution uniformity even in lower pressure conditions.

Die Wasserverteilung ist ein sehr wichtiger Aspekt in der Beregnung und deshalb ist es wichtig, Geräte mit immer besseren Leistungen zu entwickeln. Die Komet Sprinkler Produktlinie bietet höchste Leistung mit ausgezeichneter Wasserverteilung und dies auch bei geringeren Betriebsdrücken.

## 2.

### THROW WURFWEITE

A longer throw results in a larger irrigated area and this factor is fundamental to the cost effectiveness of the irrigation. Due to the hydraulic design of the sprinklers the water reaches the nozzle with the least possible turbulences and pressure losses allowing for best throw values.

Die Wurfweite bestimmt die berechnete Fläche: je größer die Wurfweite desto größer die berechnete Fläche, was wiederum die Wirtschaftlichkeit steigert. Durch den optimal gestalteten Wasserdurchfluss der Komet Regner gelangt das Wasser mit den geringst möglichen Turbulenzen und Druckverlusten zur Düse und ermöglicht so große Wurfweiten.

## 3.

### EFFICIENCY EFFIZIENZ

All irrigation operations need to achieve a correct cost balance. The quality materials used manufacturing the Komet Sprinklers allow for a long service life making them highly efficient and cost effective in a long term vision.

Die Beregnung muss in einem vernünftigen Kostenrahmen stattfinden. Die in der Fertigung verwendete Qualität der Materialien lassen eine lange Lebensdauer der Komet Produkte erwarten was sich auf lange Sicht wirtschaftlich sehr positiv auswirkt.

## 4.

### RELIABILITY ZUVERLÄSSIGKEIT

For every grower the dependability of the products he is working with is most important when he is irrigating. To make sure to achieve this goal Komet has set high standards in selecting the materials and has adopted strict quality controls throughout the manufacturing process because in the field quality matters.

Für jeden Anwender ist die Zuverlässigkeit der benutzten Arbeitsmittel das Allerwichtigste. Aus diesem Grund hat Komet schon immer die besten Materialien und Produktionstechniken eingesetzt, da am Feld die Zuverlässigkeit der Arbeitsgeräte von entscheidender Bedeutung ist.

## 5.

### ADAPTABILITY ANPASSUNGSFÄHIGKEIT

To be an effective working tool it must be adaptable to the requirements of the different usages. Komet has developed a complete product line to best adapt to the requirements of the growers and the different irrigation system requirements while delivering always best possible performance.

Um effizient zu sein, muss sich jedes Arbeitsgerät den verschiedenen Anforderungen anpassen können. Komet hat eine komplette Serie von Produkten entwickelt, welche sich bestens den Anforderungen der Anwender und der unterschiedlichen Beregnungssysteme anpassen lässt und dabei immer bestmögliche Leistung erbringt.



**The Result /  
Das Resultat**





# komet | Sprinkler 163

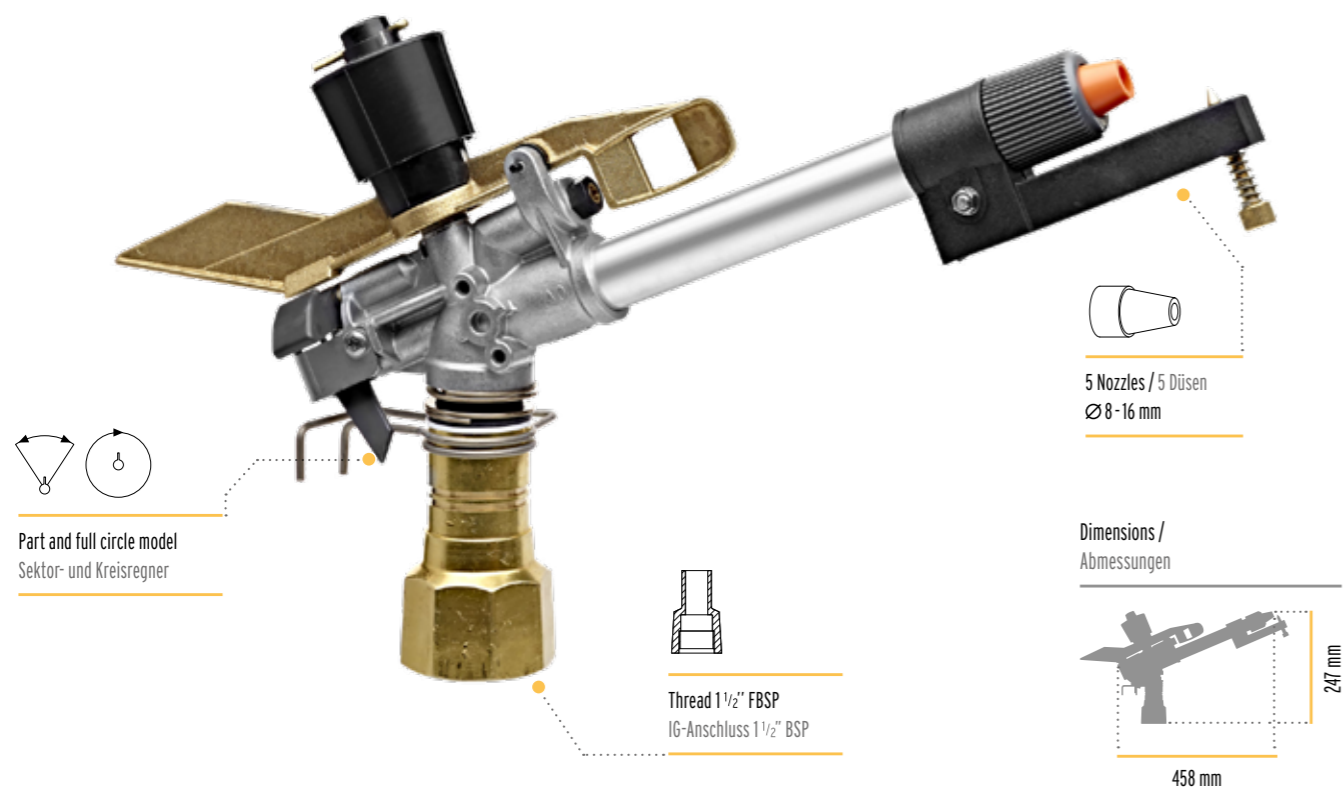

Part and full circle model  
Sektor- und Kreisregner

This medium volume sprinkler is suitable for versatile use in general field irrigation on solid-set and mechanized irrigation systems such as travellers. Changing from part circle to full circle operation is easy by adjusting the part circle stops. The Komet 163 shows good performance in windy conditions, and complements the full circle model Komet 162 where irrigation of adjacent fields is not allowed. Long wear life, high performance, proven design and maintenance free operation are among other its outstanding features.

Universal Sektor- und Kreisregner für die Mittelstarkberegnung. Die Anwendung erschließt den gesamten Bereich der extensiven landwirtschaftlichen Kulturen. Der Komet 163 findet auch Einsatz auf Beregnungsmaschinen. Er ist leistungsstark, wartungsfrei, von robuster Bauart und kann schnell von Sektor- auf Kreisbetrieb umgestellt werden.

Nozzle Düse	Pressure Druck	Throw Wurf- weite	Flow Durchfluss		Surface Fläche	Precipitation rate Regenhöhe	▲ Set-up / Verband			■ Set-up / Verband		
			m <sup>3</sup> /h	l/sec			Spacing Regner- abstand max. m	Surface Fläche m <sup>2</sup>	Precipitation rate Regenhöhe mm/h	Spacing Regner- abstand max. m	Surface Fläche m <sup>2</sup>	Precipitation rate Regenhöhe mm/h
8	2	19,5	5,377	1,494	1158	4,64	28/33	942	5,71	27	729	7,38
	3	22,0	6,585	1,829	1466	4,49	32/37	1184	5,56	30	900	7,32
	4	24,0	7,604	2,112	1779	4,27	32/41	1454	5,23	34	1156	6,58
	5	25,5	8,501	2,361	2059	4,13	38/44	1675	5,08	36	1296	6,56
10	2	21,5	6,855	1,904	1385	4,95	31/36	1122	6,11	30	900	7,62
	3	24,0	8,396	2,332	1750	4,80	35/41	1554	5,40	33	1089	7,71
	4	26,5	9,695	2,693	2124	4,56	39/45	1752	5,53	37	1369	7,08
	5	28,5	10,839	3,011	2463	4,40	42/48	1994	5,44	39	1521	7,13
12	2	23,0	8,771	2,436	1576	5,57	34/39	1315	6,67	32	1024	8,57
	3	26,0	10,742	2,984	2027	5,30	38/44	1675	6,41	36	1296	8,29
	4	28,5	12,404	3,445	2463	5,04	42/48	1994	6,22	39	1521	8,15
	5	30,5	13,868	3,852	2865	4,84	45/52	2340	5,93	43	1849	7,50
14	2	24,0	11,045	3,068	1720	6,42	35/40	1358	8,13	33	1089	10,14
	3	27,5	13,527	3,757	2290	5,91	41/47	1911	7,08	38	1444	9,37
	4	30,0	15,619	4,339	2715	5,75	44/51	2250	6,94	41	1681	9,29
	5	32,0	17,463	4,851	3097	5,64	47/54	2524	6,92	44	1936	9,02
16	2	24,5	13,083	3,634	1809	7,23	35/41	1554	8,42	34	1156	11,32
	3	28,5	16,024	4,451	2463	6,51	42/48	1994	8,04	39	1521	10,53
	4	31,5	18,503	5,140	3019	6,13	47/54	2524	7,33	44	1936	9,56
	5	33,5	20,686	5,746	3380	6,12	49/57	2811	7,36	46	2116	9,78
6	34,5	22,661	6,295	3674	6,17	51/59	3012	7,52	48	2304	9,84	

N.B.: The performance data were obtained under ideal testing conditions and may be adversely affected by wind and other factors. Pressure refers to pressure at nozzle. Consider wind speed and wind direction when designing an irrigation system. Reduce the spacing for the selected sprinkler set-up accordingly. Die in der Tabelle angegebenen Daten beziehen sich auf Windstille und können durch Windeinfluss oder andere Faktoren negativ beeinflusst werden. Der angegebene Betriebsdruck bezieht sich auf den Druck an der Düse. Bei Auslegung von Beregnungsanlagen sind Windrichtung und Windgeschwindigkeit zu berücksichtigen. Die Regnerabstände sind im Verband entsprechend zu verringern.

# komet | Sprinkler 162

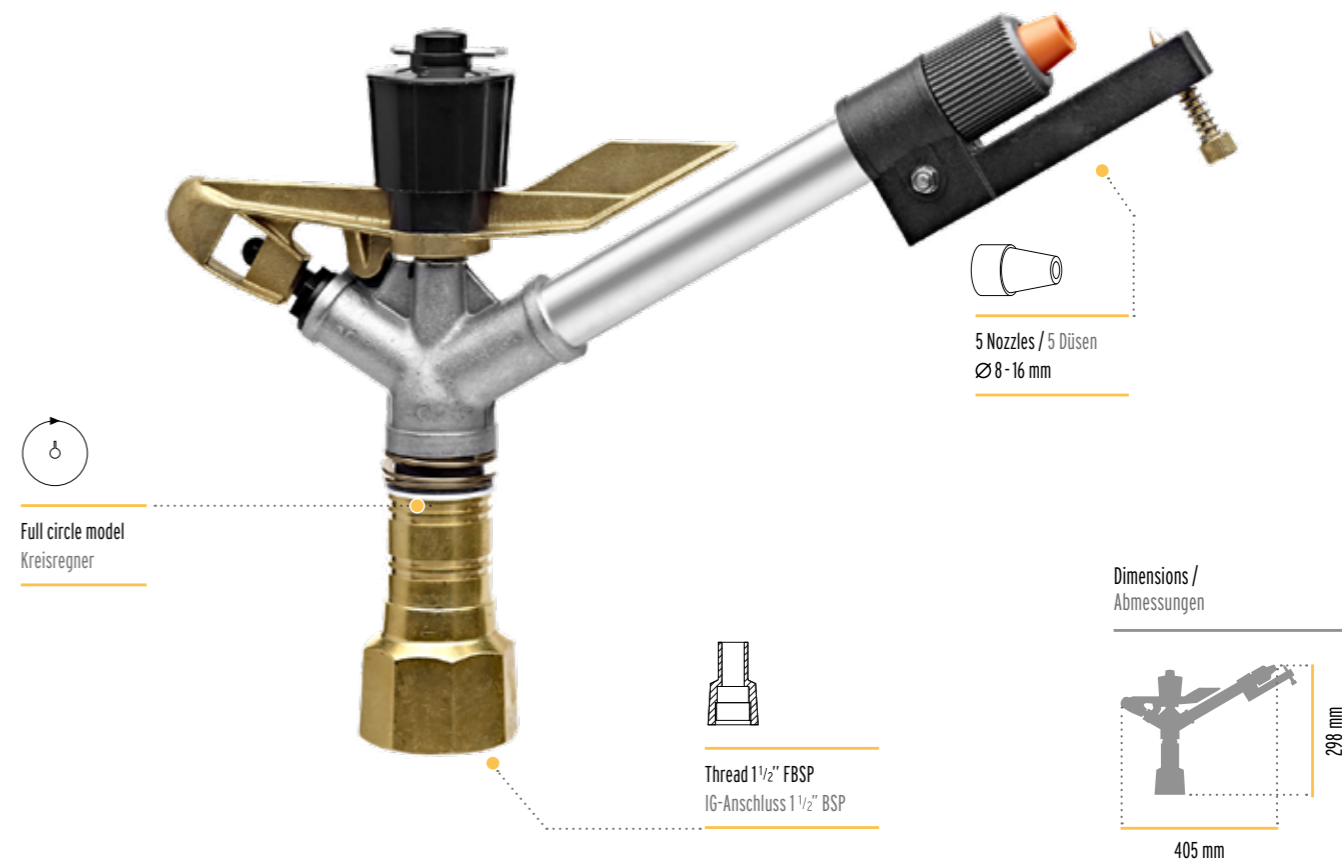

Full circle model  
Kreisregner

The Komet 162 is a medium volume sprinkler with full circle operation and the same performance and features as the Komet 163. Designed for use in general field irrigation mainly in extensive solid-set and moveable irrigation systems. Long wear life, high performance, proven design and maintenance free operation are among other its outstanding features.

Der Komet 162 ist ein Universal Kreisregner für die Mittelstarkberegnung. Die Anwendung erschließt das ganze Gebiet der extensiven landwirtschaftlichen Kulturen, insbesondere findet der Komet 162 weitgehend Einsatz in ausgedehnten ortsfesten Anlagen. Der Komet 162 ist leistungsstark, wartungsfrei und von robuster Bauart.

Nozzle Düse	Pressure Druck	Throw Wurf- weite	Flow Durchfluss		Surface Fläche	Precipitation rate Regenhöhe	▲ Set-up / Verband			■ Set-up / Verband		
			m <sup>3</sup> /h	l/sec			Spacing Regner- abstand max. m	Surface Fläche m <sup>2</sup>	Precipitation rate Regenhöhe mm/h	Spacing Regner- abstand max. m	Surface Fläche m <sup>2</sup>	Precipitation rate Regenhöhe mm/h
8	2	19,5	6,293	1,748	1158	5,43	28/33	942	6,68	27	729	8,63
	3	22,0	7,708	2,141	1466	5,26	32/37	1184	6,51	30	900	8,56
	4	24,0	8,900	2,472	1779	5,00	32/41	1454	6,12	34	1156	7,70
	5	25,5	9,950	2,764	2059	4,83	38/44	1675	5,94	36	1296	7,68
10	2	21,5	8,079	2,244	1385	5,83	31/36	1122	7,20	30	900	8,98
	3	24,0	9,895	2,749	1750	5,65	35/41	1454	6,81	33	1089	9,09
	4	26,5	11,425	3,174	2124	5,38	39/45	1752	6,52	37	1369	8,35
	5	28,5	12,774	3,548	2463	5,19	42/48	1994	6,41	39	1521	8,40
12	2	23,0	9,981	2,773	1576	6,33	34/39	1315	7,59	32	1024	9,75
	3	26,0	12,225	3,396	2027	6,03	38/44	1675	7,30	36	1296	9,43
	4	28,5	14,116	3,921	2463	5,73	42/48	1994	7,08	39	1521	9,28
	5	30,5	15,782	4,384	2865	5,51	45/52	2340	6,74	43	1849	8,54
14	2	24,0	12,354	3,432	1720	7,18	35/40	1385	8,92	33	1089	11,34
	3	27,5	15,130	4,203	2290	6,61	41/47	1911	7,92	38	1444	10,48
	4	30,0	17,471	4,853	2715	6,44	44/51	2250	7,76	41	1681	10,39
	5	32,0	19,533	5,426	3097	6,31	47/54	2524	7,74	44	1936	10,09
16	2	24,5	14,483	4,023	1809	8,01	35/41	1454	9,96	34	1156	12,53
	3	28,5	17,738	4,927	2463	7,20	42/48	1994	9,08	39	1521	11,66
	4	31,5	20,482	5,689	3019	6,78	47/54	2524	8,11	44	1936	10,58
	5	33,5	22,899	6,361	3380	6,77	49/57	2811	8,15	46	2116	10,82
6	34,5	25,085	6,968	3674	6,83	51/59	3012	8,33	48	2304	10,89	

N.B.: The performance data were obtained under ideal testing conditions and may be adversely affected by wind and other factors. Pressure refers to pressure at nozzle. Consider wind speed and wind direction when designing an irrigation system. Reduce the spacing for the selected sprinkler set-up accordingly. Die in der Tabelle angegebenen Daten beziehen sich auf Windstille und können durch Windeinfluss oder andere Faktoren negativ beeinflusst werden. Der angegebene Betriebsdruck bezieht sich auf den Druck an der Düse. Bei Auslegung von Beregnungsanlagen sind Windrichtung und Windgeschwindigkeit zu berücksichtigen. Die Regnerabstände sind im Verband entsprechend zu verringern.

# komet | Sprinkler R20



The Komet R20 is a medium / low volume sprinkler and is suitable for versatile use in general field irrigation on solid-set and mechanized irrigation systems such as travellers. The Komet R20 shows good performance also in medium to low pressures conditions. Long wear life, high performance, proven design and maintenance free operation are among other its outstanding features.

Der Komet R20 ist ein Universal Sektor- und Kreisregner für die Mittelstark- und Schwachberegnung. Die Anwendung erschließt den gesamten Bereich der extensiven landwirtschaftlichen Kulturen. Er wird auch auf Beregnungsmaschinen eingesetzt. Er ist leistungsstark, wartungsfrei, von robuster Bauart und kann schnell von Sektor- auf Kreisbetrieb umgestellt werden.

Nozzle Düse	Pressure Druck	Throw Wurf- weite	Flow Durchfluss		Surface Fläche	Precipitation rate Regenhöhe	▲ Set-up / Verband			■ Set-up / Verband		
			m <sup>3</sup> /h	l/sec			Spacing Regner- abstand	Surface Fläche	Precipitation rate Regenhöhe	Spacing Regner- abstand	Surface Fläche	Precipitation rate Regenhöhe
mm	bar	m	m <sup>3</sup> /h	l/sec	m <sup>2</sup>	mm/h	max. m	m <sup>2</sup>	mm/h	max. m	m <sup>2</sup>	mm/h
6	2,5	16,5	2,09	0,582	855	2,44	24/28	678	3,08	23	529	3,95
	3,5	19,0	2,48	0,689	1133	2,19	28/33	942	2,63	26	676	3,67
	4,5	21,0	2,81	0,781	1385	2,03	31/36	1121	2,51	29	841	3,34
7	2,0	16,5	2,55	0,709	855	2,98	24/28	678	3,76	23	529	4,82
	3,0	19,0	3,12	0,868	1133	2,75	28/33	942	3,31	26	676	4,61
	4,0	21,0	3,61	1,002	1385	2,60	31/36	1121	3,22	29	841	4,29
8	2,0	18,0	3,33	0,926	1017	3,27	26/31	931	4,01	25	625	5,33
	3,0	21,0	4,08	1,134	1385	2,94	31/36	1121	3,64	29	841	4,85
	4,0	22,5	4,72	1,310	1590	2,97	33/39	1315	3,59	31	941	4,91
10	2,0	19,5	5,21	1,447	1194	4,36	28/33	942	5,53	27	729	7,15
	3,0	22,0	6,38	1,772	1520	4,20	33/38	1249	5,11	31	961	6,64
	4,0	24,0	7,36	2,046	1808	4,07	35/41	1454	5,06	34	1156	6,36
12	2,5	22,0	8,38	2,329	1520	5,51	33/38	1249	6,71	31	961	8,72
	3,5	24,0	9,92	2,756	1808	5,48	35/41	1454	6,42	34	1156	8,58
	4,5	26,0	11,25	3,125	2122	5,30	39/45	1751	6,42	36	1296	8,68

N.B.: The performance data were obtained under ideal testing conditions and may be adversely affected by wind and other factors. Pressure refers to pressure at nozzle. Consider wind speed and wind direction when designing an irrigation system. Reduce the spacing for the selected sprinkler set-up accordingly. Die in der Tabelle angegebenen Daten beziehen sich auf Windstille und können durch Windeinfluss oder andere Faktoren negativ beeinflusst werden. Der angegebene Betriebsdruck bezieht sich auf den Druck an der Düse. Bei Auslegung von Beregnungsanlagen sind Windrichtung und Windgeschwindigkeit zu berücksichtigen. Die Regnerabstände sind im Verband entsprechend zu verringern.

# komet | Sprinkler R8



The Komet R8 is a medium / low volume sprinkler and is suitable for versatile use in general field irrigation on solid-set systems. The Komet R8 shows good performance also in medium to low pressures conditions. Long wear life, high performance, proven design and maintenance free operation are among other its outstanding features.

Der Komet R8 ist ein Universal Kreisregner für die Mittelstark- und Schwachberegnung. Die Anwendung erschließt das ganze Gebiet der extensiven landwirtschaftlichen Kulturen, insbesondere findet der Komet R8 weitgehend Einsatz in ausgedehnten ortsfesten Anlagen. Der Komet R8 ist leistungsstark, wartungsfrei und von robuster Bauart.

Nozzle Düse	Pressure Druck	Throw Wurf- weite	Flow Durchfluss		Surface Fläche	Precipitation rate Regenhöhe	▲ Set-up / Verband			■ Set-up / Verband		
			m <sup>3</sup> /h	l/sec			Spacing Regner- abstand	Surface Fläche	Precipitation rate Regenhöhe	Spacing Regner- abstand	Surface Fläche	Precipitation rate Regenhöhe
mm	bar	m	m <sup>3</sup> /h	l/sec	m <sup>2</sup>	mm/h	max. m	m <sup>2</sup>	mm/h	max. m	m <sup>2</sup>	mm/h
6	1,5	14,0	1,62	0,451	615	2,63	20/24	498	3,25	19	361	4,49
	2,5	16,5	2,09	0,582	855	2,44	24/28	678	3,08	23	529	3,95
	3,5	19,0	2,48	0,689	1133	2,19	28/33	942	2,63	26	676	3,67
	4,5	21,0	2,81	0,781	1385	2,03	31/36	1121	2,51	29	841	3,34
7	2,0	16,5	2,55	0,709	855	2,98	24/28	678	3,76	23	529	4,82
	3,0	19,0	3,12	0,868	1133	2,75	28/33	942	3,31	26	676	4,61
	4,0	21,0	3,61	1,002	1385	2,60	31/36	1121	3,22	29	841	4,29
	4,0	21,0	3,61	1,002	1385	2,60	31/36	1121	3,22	29	841	4,29
8	2,0	18,0	3,33	0,926	1017	3,27	26/31	931	4,01	25	625	5,33
	3,0	21,0	4,08	1,134	1385	2,94	31/36	1121	3,64	29	841	4,85
	4,0	22,5	4,72	1,310	1590	2,97	33/39	1315	3,59	31	941	4,91
	4,0	22,5	4,72	1,310	1590	2,97	33/39	1315	3,59	31	941	4,91
10	2,0	19,5	5,21	1,447	1194	4,36	28/33	942	5,53	27	729	7,15
	3,0	22,0	6,38	1,772	1520	4,20	33/38	1249	5,11	31	961	6,64
	4,0	24,0	7,36	2,046	1808	4,07	35/41	1454	5,06	34	1156	6,36
	4,0	24,0	7,36	2,046	1808	4,07	35/41	1454	5,06	34	1156	6,36
12	2,5	22,0	8,38	2,329	1520	5,51	33/38	1249	6,71	31	961	8,72
	3,5	24,0	9,92	2,756	1808	5,48	35/41	1454	6,42	34	1156	8,58
	4,5	26,0	11,25	3,125	2122	5,30	39/45	1751	6,42	36	1296	8,68
	4,5	26,0	11,25	3,125	2122	5,30	39/45	1751	6,42	36	1296	8,68

N.B.: The performance data were obtained under ideal testing conditions and may be adversely affected by wind and other factors. Pressure refers to pressure at nozzle. Consider wind speed and wind direction when designing an irrigation system. Reduce the spacing for the selected sprinkler set-up accordingly. Die in der Tabelle angegebenen Daten beziehen sich auf Windstille und können durch Windeinfluss oder andere Faktoren negativ beeinflusst werden. Der angegebene Betriebsdruck bezieht sich auf den Druck an der Düse. Bei Auslegung von Beregnungsanlagen sind Windrichtung und Windgeschwindigkeit zu berücksichtigen. Die Regnerabstände sind im Verband entsprechend zu verringern.

# komet | Sprinkler F41 - F41/2 - F43

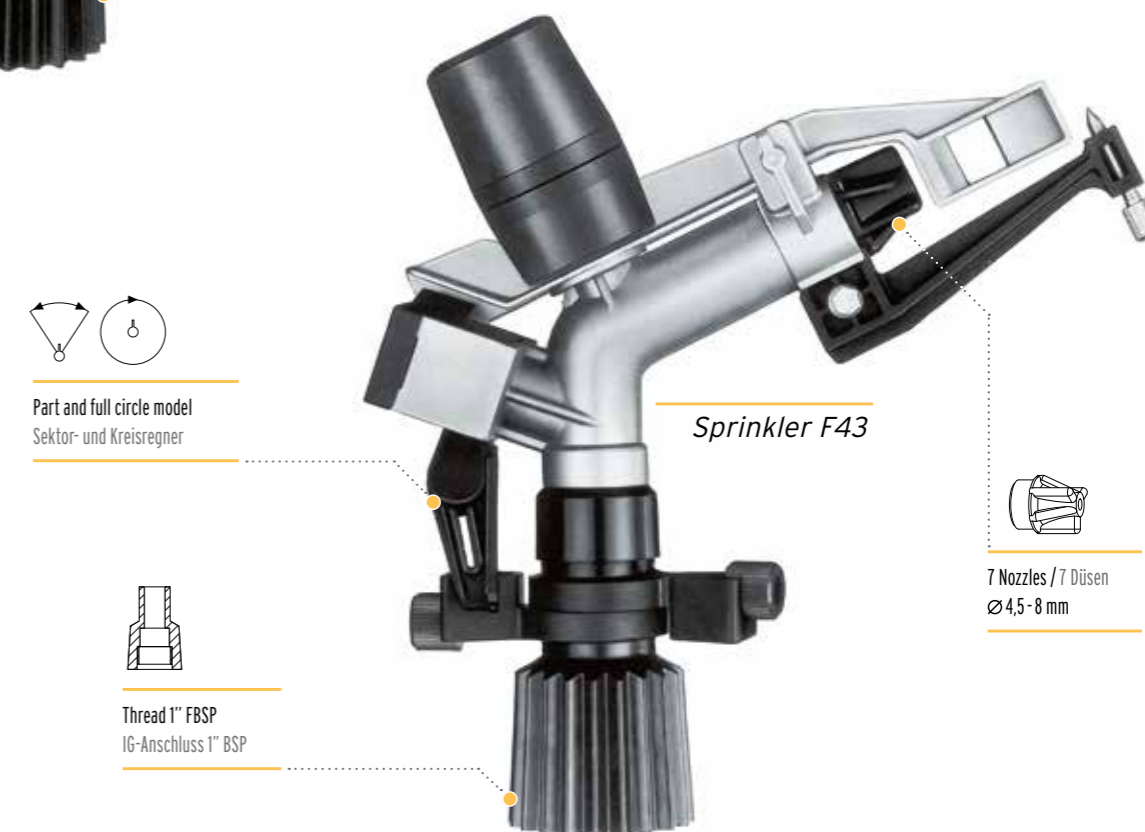
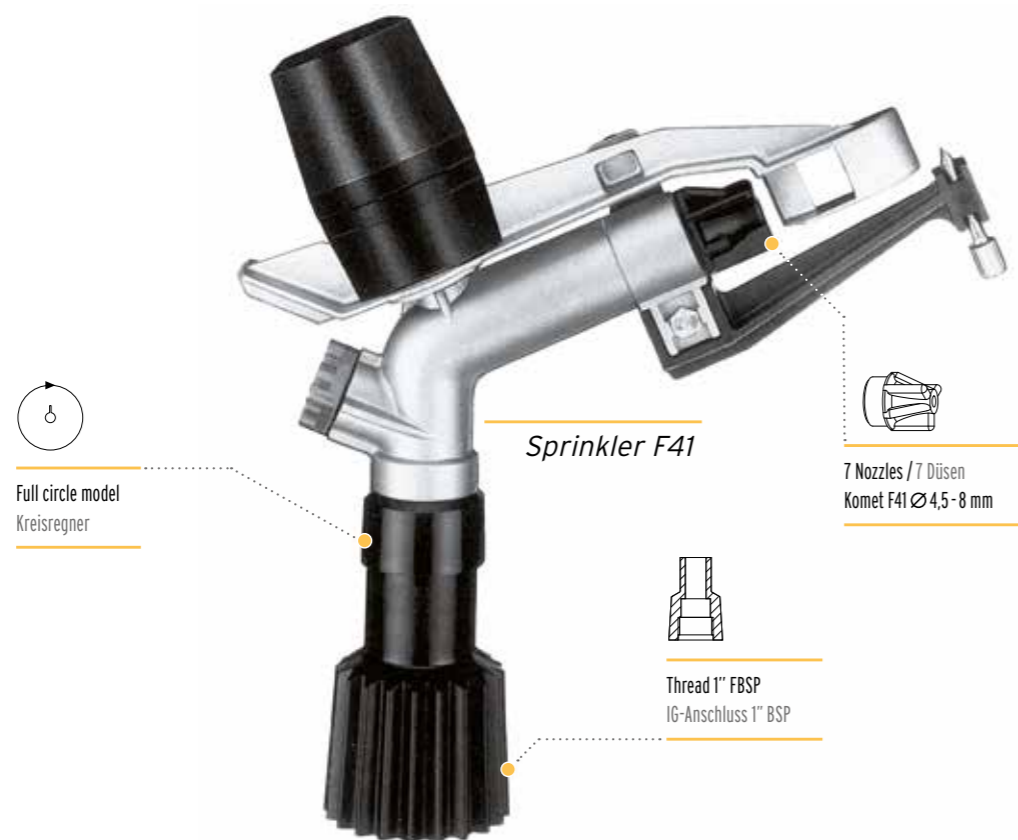

## komet | Sprinkler F41

The Komet F41, single jet and full circle sprinkler, is suitable for versatile use on solid-set irrigation systems. The Komet F41 shows good performance also in medium to low pressures conditions and an outstanding uniformity in the water distribution. Long wear life, high performance, proven design and maintenance free operation are among other its outstanding features.

Der Komet F41, Einstrahl-Kreisregner für die Schwachberegnung findet weitgehend Einsatz in ortsfesten Anlagen. Ausgezeichnete Funktion und Wasserverteilung auch bei Niederdruck. Der Komet F41 ist leistungsstark, wartungsfrei und von robuster Bauart.

## komet | Sprinkler F41/2

The Komet F41/2, double jet and full circle sprinkler, is suitable for versatile use on solid-set irrigation systems. The Komet F41/2 shows good performance also in medium to low pressures conditions and an outstanding uniformity in the water distribution. Long wear life, high performance, proven design and maintenance free operation are among other its outstanding features.

Der Komet F41/2, Zweistrahler-Kreisregner für die Schwachberegnung findet weitgehend Einsatz in ortsfesten Anlagen. Ausgezeichnete Funktion und Wasserverteilung auch bei Niederdruck. Der Komet F41/2 ist leistungsstark, wartungsfrei und von robuster Bauart.

## komet | Sprinkler F43

The Komet F43, part and full circle sprinkler is suitable for versatile use on solid-set irrigation systems. The Komet F43 shows good performance also in medium to low pressures conditions. Changing from part circle to full circle operation is easy by adjusting the part circle stops. Long wear life, high performance, proven design and maintenance free operation are among other its outstanding features.

Der Komet F43, Kreis- und Sektorregner für die Schwachberegnung findet weitgehend Einsatz in ortsfesten Anlagen. Ausgezeichnete Funktion und Wasserverteilung auch bei Niederdruck. Der Komet F43 ist leistungsstark, wartungsfrei und von robuster Bauart und kann schnell von Sektor- auf Kreisbetrieb umgestellt werden.



# komet | Sprinkler F41 -F43

Dimensions / Abmessungen

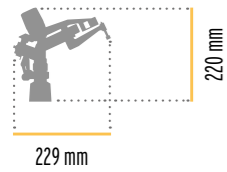

Dimensions / Abmessungen

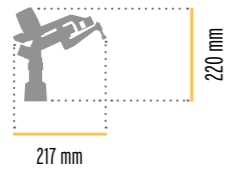

Nozzle Düse	Pressure Druck	Throw Wurf- weite	Flow / Durchfluss		Surface Fläche	Precipitation rate Regenhöhe	▲ Set-up / Verband			■ Set-up / Verband		
			m <sup>3</sup> /h	l/sec			Spacing Regnerabstand	Surface Fläche	Precipitation rate Regenhöhe	Spacing Regnerabstand	Surface Fläche	Precipitation rate Regenhöhe
mm	bar	m			m <sup>2</sup>	mm/h	max. m	m <sup>2</sup>	mm/h	max. m	m <sup>2</sup>	mm/h
4,5	2,0	13,8	1,05	0,29	598	1,76	20,7/23,9	494	2,12	19,5	380	2,76
	2,5	14,8	1,18	0,33	688	1,71	22,2/25,6	569	2,07	20,9	438	2,69
	3,0	15,7	1,29	0,36	774	1,67	23,5/27,2	640	2,01	22,2	493	2,62
	3,5	16,5	1,40	0,39	855	1,64	24,7/28,6	707	1,98	23,3	544	2,57
	4,5	17,8	1,58	0,44	995	1,59	26,7/30,8	823	1,92	25,1	633	2,49
5,0	2,0	14,2	1,30	0,36	633	2,05	21,3/24,6	524	2,48	20,1	403	3,22
	2,5	15,3	1,46	0,40	735	1,99	22,9/26,5	608	2,40	21,6	468	3,12
	3,0	16,2	1,59	0,44	824	1,93	24,3/28,0	681	2,33	22,9	524	3,03
	3,5	17,0	1,72	0,48	908	1,89	25,5/29,4	750	2,29	24,0	578	2,97
	4,5	18,4	1,95	0,54	1063	1,83	27,6/31,8	879	2,22	26,0	677	2,88
5,5	2,0	14,7	1,58	0,44	678	2,33	22,0/25,4	561	2,81	20,8	432	3,66
	2,5	15,7	1,76	0,49	774	2,27	23,5/27,2	640	2,75	22,2	492	3,57
	3,0	16,7	1,93	0,54	876	2,20	25,0/28,9	724	2,66	23,6	557	3,46
	3,5	17,5	2,08	0,58	962	2,16	26,2/30,3	795	2,61	24,7	612	3,40
	4,5	19,0	2,36	0,66	1134	2,08	28,5/32,9	938	2,52	26,8	722	3,27
6,0	2,0	15,0	1,88	0,52	706	2,66	22,5/26,0	584	3,22	21,2	449	4,18
	2,5	16,2	2,10	0,58	824	2,55	24,3/28,0	682	3,08	22,9	524	4,00
	3,0	17,1	2,30	0,64	918	2,50	25,6/29,6	759	3,03	24,1	584	3,93
	3,5	18,0	2,48	0,69	1017	2,44	27,0/31,1	841	2,95	25,4	647	3,83
	4,5	19,5	2,81	0,78	1194	2,35	29,2/33,7	988	2,84	27,6	760	3,70
6,5	2,0	15,4	2,20	0,61	745	2,95	23,1/26,6	616	3,57	21,8	474	4,64
	2,5	16,5	2,46	0,68	855	2,88	24,7/28,5	707	3,48	23,3	544	4,52
	3,0	17,5	2,70	0,75	962	2,81	26,2/30,3	795	3,39	24,7	612	4,41
	3,5	18,4	2,91	0,81	1063	2,74	27,6/31,8	879	3,31	26,0	677	4,30
	4,5	20,0	3,30	0,92	1256	2,63	30,0/34,6	1039	3,18	28,2	799	4,13
7,0	2,0	15,7	2,55	0,71	774	3,29	23,5/27,2	640	3,98	22,2	493	5,17
	2,5	16,9	2,85	0,79	897	3,18	25,3/29,2	742	3,84	23,9	571	4,99
	3,0	17,9	3,13	0,87	1006	3,11	26,8/31,0	832	3,76	25,3	640	4,88
	3,5	18,8	3,38	0,94	1110	3,04	28,2/32,5	918	3,68	26,6	707	4,78
	4,5	20,4	3,83	1,06	1307	2,93	30,6/35,3	1081	3,54	28,8	832	4,60
8,0	2,0	16,3	3,33	0,93	834	3,99	24,4/28,2	690	4,82	23,0	531	6,27
	2,5	17,5	3,73	1,04	962	3,88	26,2/30,3	795	4,69	24,7	612	6,09
	3,0	18,6	4,08	1,13	1087	3,75	27,9/32,2	899	4,54	26,3	692	5,90
	3,5	19,5	4,41	1,23	1194	3,69	29,2/33,7	987	4,46	27,5	760	5,80
	4,5	21,2	5,00	1,39	1411	3,54	31,8/36,7	1167	4,28	30,0	900	5,56

N.B.: The performance data were obtained under ideal testing conditions and may be adversely affected by wind and other factors. Pressure refers to pressure at nozzle. Consider wind speed and wind direction when designing an irrigation system. Reduce the spacing for the selected sprinkler set-up accordingly. Die in der Tabelle angegebenen Daten beziehen sich auf Windstille und können durch Windeinfluss oder andere Faktoren negativ beeinflusst werden. Der angegebene Betriebsdruck bezieht sich auf den Druck an der Düse. Bei Auslegung von Berechnungsanlagen sind Windrichtung und Windgeschwindigkeit zu berücksichtigen. Die Regnerabstände sind im Verband entsprechend zu verringern.

# komet | Sprinkler F41/2

Dimensions / Abmessungen

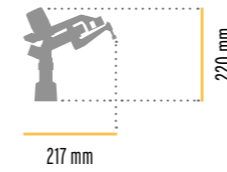

Nozzle Düse	Pressure Druck	Throw Wurf- weite	Flow / Durchfluss		Surface Fläche	Precipitation rate Regenhöhe	▲ Set-up / Verband			■ Set-up / Verband		
			m <sup>3</sup> /h	l/sec			Spacing Regnerabstand	Surface Fläche	Precipitation rate Regenhöhe	Spacing Regnerabstand	Surface Fläche	Precipitation rate Regenhöhe
mm	bar	m			m <sup>2</sup>	mm/h	max. m	m <sup>2</sup>	mm/h	max. m	m <sup>2</sup>	mm/h
4,5 x 3,2	2,0	13,8	1,62	0,45	598	2,71	20,7/23,9	495	3,27	19,5	381	4,25
	2,5	14,8	1,81	0,50	688	2,63	22,2/25,6	569	3,18	20,9	438	4,13
	3,0	15,7	1,99	0,55	774	2,57	23,5/27,2	640	3,11	22,2	493	4,04
	3,5	16,5	2,14	0,60	855	2,50	24,7/28,6	707	3,03	23,3	544	3,93
	4,5	17,8	2,43	0,68	995	2,44	26,7/30,8	823	2,95	25,1	633	3,83
5,0 x 3,2	2,0	14,2	1,84	0,51	633	2,90	21,3/24,6	524	3,51	20,1	404	4,56
	2,5	15,3	2,05	0,57	735	2,79	22,9/26,5	608	3,37	21,6	468	4,38
	3,0	16,2	2,25	0,62	824	2,73	24,3/28,0	682	3,30	22,9	525	4,29
	3,5	17,0	2,43	0,67	908	2,68	25,5/29,4	750	3,24	24,0	578	4,20
	4,5	18,4	2,75	0,76	1063	2,59	27,6/31,8	879	3,13	26,0	677	4,06
5,5 x 3,2	2,0	14,7	2,11	0,59	678	3,11	22,0/25,4	561	3,76	20,8	433	4,88
	2,5	15,7	2,36	0,65	774	3,05	23,5/27,2	640	3,69	22,2	493	4,79
	3,0	16,7	2,58	0,72	876	2,94	25,0/28,9	724	3,56	23,6	558	4,63
	3,5	17,5	2,79	0,77	962	2,90	26,2/30,3	795	3,51	24,7	612	4,56
	4,5	19,0	3,16	0,88	1134	2,79	28,5/32,9	938	3,37	25,8	722	4,38
6,0 x 3,2	2,0	15,0	2,41	0,67	706	3,41	22,5/26,0	584	4,12	21,2	450	5,36
	2,5	16,2	2,69	0,75	824	3,26	24,3/28,0	682	3,95	22,9	525	5,13
	3,0	17,1	2,95	0,82	918	3,21	25,6/29,6	759	3,88	24,1	584	5,04
	3,5	18,0	3,19	0,89	1017	3,13	27,0/31,1	841	3,79	25,4	648	4,92
	4,5	19,5	3,61	1,00	1194	3,02	29,2/33,7	988	3,65	27,6	760	4,75
6,5 x 3,2	2,0	15,4	2,73	0,76	745	3,66	23,1/26,6	616	4,43	21,8	474	5,76
	2,5	16,5	3,06	0,85	855	3,58	24,7/28,5	707	4,33	23,3	544	5,62
	3,0	17,5	3,35	0,93	962	3,48	26,2/30,3	795	4,21	24,7	612	5,47
	3,5	18,4	3,62	1,00	1063	3,40	27,6/31,8	879	4,12	26,0	677	5,35
	4,5	20,0	4,10	1,14	1256	3,26	30,0/34,6	1039	3,95	28,3	800	5,13
7,0 x 3,2	2,0	15,7	3,09	0,86	774	3,99	23,5/27,2	640	4,83	22,2	492	6,27
	2,5	16,9	3,45	0,96	897	3,84	25,3/29,2	742	4,65	23,9	571	6,04
	3,0	17,9	3,78	1,05	1006	3,76	26,8/31,0	832	4,54	25,3	641	5,90
	3,5	18,8	4,08	1,13	1110	3,67	28,2/32,5	918	4,44	26,6	707	5,77
	4,5	20,4	4,63	1,29	1307	3,54	30,6/35,3	1081	4,28	28,8	832	5,56
8,0 x 3,2	2,0	16,3	3,87	1,07	834	4,64	24,4/28,2	690	5,61	23,0	530	7,28
	2,5	17,5	4,32	1,20	962	4,49	26,2/30,3	795	5,43	24,7	612	7,05
	3,0	18,6	4,74	1,32	1087	4,36	27,9/32,2	899	5,27	26,3	692	6,85
	3,5	19,5	5,12	1,42	1194	4,29	29,2/33,7	987	5,18	27,5	760	6,73
	4,5	21,2	5,80	1,61	1411	4,11	31,8/36,7	1167	4,97	29,9	899	6,45

N.B.: The performance data were obtained under ideal testing conditions and may be adversely affected by wind and other factors. Pressure refers to pressure at nozzle. Consider wind speed and wind direction when designing an irrigation system. Reduce the spacing for the selected sprinkler set-up accordingly. Die in der Tabelle angegebenen Daten beziehen sich auf Windstille und können durch Windeinfluss oder andere Faktoren negativ beeinflusst werden. Der angegebene Betriebsdruck bezieht sich auf den Druck an der Düse. Bei Auslegung von Berechnungsanlagen sind Windrichtung und Windgeschwindigkeit zu berücksichtigen. Die Regnerabstände sind im Verband entsprechend zu verringern.



## Charts and hints

### 1) Average daily watering requirements

- cold and humid climate	2,5 mm = l/sec per hectare 0,29
- cold and dry climate	3,8 mm = l/sec per hectare 0,44
- moderate and humid climate	3,8 mm = l/sec per hectare 0,44
- moderate and dry climate	5,1 mm = l/sec per hectare 0,59
- hot and humid climate	5,1 mm = l/sec per hectare 0,59
- hot and dry climate	7,6 mm = l/sec per hectare 0,88

### 2) Intake rates of various soils per hour (level ground)

- sand	19-25 mm/hour
- loamy sand	12-19 mm/hour
- sandy loam	up to 12 mm/hour
- loam	up to 10 mm/hour
- silt	up to 8 mm/hour

### 3) Slope precipitation table

Grade of slope	Precipitation rate reduction
0 - 5%	0%
6 - 8%	20%
9 - 12%	40%
13 - 20%	60%
over 20%	75%

### 4) Wind and sprinkler spacing

Wind is a very crucial factor in irrigation and wind speed and direction have to be taken into account when determining the spacing of sprinklers. Throws in the charts are based on conditions assuming the absence of wind, which is the exception in real life. Maximum spacings between sprinklers and between laterals have to be reduced according to wind speed.

It is suggested for example:

Average wind speed		Reduction factor (throw)	SETUP ■		SETUP ▲	
km/h	m/sec		spacing between sprinklers	spacing between laterals	spacing between sprinklers	spacing between laterals
0 - 3	0,85	0,90	1,25 R*	1,30 R	1,60 R	1,35 R
3 - 7	0,85 - 2	0,85	1,20 R	1,20 R	1,50 R	1,30 R
7 - 10	2 - 3	0,80	1,10 R	1,20 R	1,40 R	1,20 R
over 10	over 3	0,70	1,00 R	1,10 R	1,20 R	1,10 R

\* R (Radius) = distance of throw

### 5) Determination of the required water supply

$$q = qs \times F \frac{24}{h}$$

where:

q = Water requirements in l/sec

qs = specific water requirements in l/sec/ha (as under pt. 1)

F = Area to be irrigated in ha

h = hours of irrigation per day

### 6) Selection of set-up and sprinkler spacing

a) Square or rectangular set-up is preferred for movable systems.

In the absence of wind the maximum theoretical sprinkler spacing can be calculated as follows:

$$L = \sqrt{2} R$$

where:

L = Length of square in m = sprinkler spacing

R = Radius = distance of throw in m can be obtained from the charts.

**IMPORTANT:** reduce spacing according to average prevailing wind speed

(as under pt. 4)

b) Triangular setup is preferred in solid set systems and for frost protection systems.

In the absence of wind maximum spacing can be calculated as follows:

Between sprinklers  $L_1 = \sqrt{3} R$

Between laterals  $L_2 = 1,5 R$

The irrigated area F covered by any chosen setup is calculated as follows:

$$F = L_1 \times L_2$$

**IMPORTANT:** reduce spacing according to average prevailing wind speed (as under pt. 4)

### 7) Precipitation

Precipitation is the amount of water applied evenly to a certain area within 1 hour measured in mm/hour and is calculated as follows:

$$i = \frac{q \times 1000}{L_1 \times L_2}$$

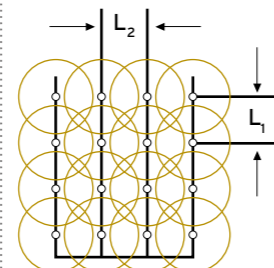

where:

q = discharge of sprinkler in m<sup>3</sup>/h

i = precipitation in mm/h

This formula applies to any setup ▲ and ■

**IMPORTANT:** i should not be higher than the intake rate of the prevailing soil corrected for any existing slope (see point 2 and 3).

### 8) Running time of irrigation equipment

Running time necessary to apply the desired precipitation rate is calculated as follows:

$$T = \frac{H}{i}$$

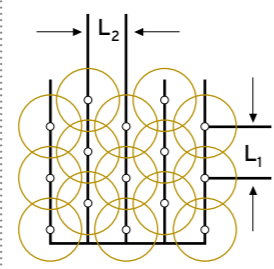

where:

T = running time in hours

H = desired precipitation rate in mm

i = precipitation rate in mm/h

An easy evaluation of the irrigated area and the precipitation rate as a result of reduced spacings due to wind can be done using the factors in this table. The performance data of the sprinklers refer to no wind condition.

wind speed km/h	% reduction of ▲ and ■ spacing	% reduction of covered area	% increase precipitation rate
0 - 3	- 8%	- 16%	+ 16%
3 - 7	- 14%	- 28%	+ 28%
7 - 10	- 20%	- 40%	+ 40%
over 10	- 30%	- 60%	+ 60%

**NOTE:** Information given on this page is based on average conditions and given for the purpose of orientation and to show examples of the most common variations of conditions and their qualitative influence on irrigation. Any data given are deemed reliable but not guaranteed.

## Technische Hinweise

### 1) Täglicher Wasserbedarf, Durchschnittswerte

- kaltes und feuchtes Klima	2,5 mm = l/s pro ha 0,29
- kaltes und trockenes Klima	3,8 mm = l/s pro ha 0,44
- gemäßigtes und feuchtes Klima	3,8 mm = l/s pro ha 0,44
- gemäßigtes und trockenes Klima	5,1 mm = l/s pro ha 0,59
- warmes und feuchtes Klima	5,1 mm = l/s pro ha 0,59
- warmes und trockenes Klima	7,6 mm = l/s pro ha 0,88

### 2) Wasseraufnahmevermögen des Bodens

- Sand	19-25 mm/h
- lehmiger Sand	12-19 mm/h
- sandiger Lehm	bis 12 mm/h
- Lehm	bis 10 mm/h
- Ton	bis 8 mm/h

### 3) Einfluss der Hangneigung

Hangneigung	Verminderung der Wasseraufnahmefähigkeit des Bodens
0 - 5%	0%
6 - 8%	20%
9 - 12%	40%
13 - 20%	60%
über 20%	75%

### 4) Windeinfluss

Wind ist bekanntlich der größte Störfaktor in der Berechnung, er ist durch zweckmäßige Reduzierung der Regnerabstände im Verband unbedingt zu berücksichtigen. Absolute Windstille wie sie den Tabellen zu Grunde liegt, ist ein Ausnahmefall, es ist deshalb bei der Auslegung jeder Anlage der Einfluss des Windes mit seiner Richtung und Geschwindigkeit unbedingt entsprechend zu berücksichtigen. Man verwendet hierzu einen proportional der Windgeschwindigkeit entsprechenden Verringerungskoeffizienten.

Man empfiehlt z.B.:

Windgeschwindigkeit		Verringerungskoeffizient	■ VERBAND		▲ VERBAND	
km/h	m/sec		Abstand auf Leitung	Ab. zwischen Leitungen	Abstand auf Leitung	Ab. zwischen Leitungen
0 - 3	0,85	0,90	1,25 R*	1,30 R	1,60 R	1,35 R
3 - 7	0,85 - 2	0,85	1,20 R	1,20 R	1,50 R	1,30 R
7 - 10	2 - 3	0,80	1,10 R	1,20 R	1,40 R	1,20 R
über 10	über 3	0,70	1,00 R	1,10 R	1,20 R	1,10 R

\* R = Wurfweite

### 5) Ermittlung des Wasserbedarfs

$$q = qs \times F \frac{24}{h}$$

wobei:

q = Wasserverbrauch in l/sec

qs = spezifischer Wasserverbrauch in l/sec/ha (siehe Pkt. 1)

F = zu berechnende Fläche in ha

h = Stunden pro Tag

### 6) Auswahl eines Verbandes und Ermittlung der Regnerabstände

a) Viereck- oder Rechteckverband wird bei beweglichen Anlagen bevorzugt.

Bei Windstille ist der maximale, theoretische Regnerabstand:

$$L = \sqrt{2} R$$

wobei:

L = Seitenlänge des Vierecks in m

R = Wurfweite des Regners in m

Die Werte für R werden den Tabellen entnommen.

**WICHTIG:** nicht vergessen, die Windverhältnisse zu berücksichtigen (siehe Pkt. 4)

b) Dreieck-Verband wird bei stationären und bei Frostschutzanlagen bevorzugt.

Bei Windstille sind die maximalen, theoretischen Regnerabstände:

auf der Leitung:  $L_1 = \sqrt{3} R$

zwischen den Leitungen:  $L_2 = 1,5 R$

Die berechnete Fläche F jeder X-beliebigen Regneraufstellung errechnet sich aus dem Produkt des Regnerabstandes auf der Leitung und des Regnerabstandes zwischen den Leitungen:

$$F = L_1 \times L_2$$

**WICHTIG:** nicht vergessen, die Windverhältnisse zu berücksichtigen.

### 7) Niederschlagshöhe

Die Niederschlagshöhe ist die auf eine Fläche in einer Stunde entfallende Regenmenge in mm/h.

Sie errechnet sich:

$$i = \frac{q \times 1000}{L_1 \times L_2}$$

wobei:

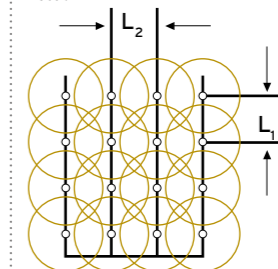

q = Wasserverbrauch eines Regners in m<sup>3</sup>/h

i = Niederschlagshöhe in mm/h

Diese Formel gilt für jede Art von Aufstellung, sei es ▲ - oder ■ - Verband

**WICHTIG:** Der Wert der Niederschlagshöhe soll die Werte der Wasseraufnahmefähigkeit des Bodens, auch Hanglagen berücksichtigen, nicht überschreiten. (siehe Pkt. 2 und 3)

### 8) Einschaltdauer der Anlage

$$T = \frac{H}{i}$$

wobei:

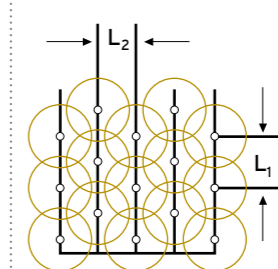

T = Einschaltdauer in h

H = gewünschte Niederschlagshöhe in mm

i = Niederschlagshöhe in mm/h

Die einfache und schnelle Ermittlung der berechneten Fläche und der Niederschlagshöhe in Abhängigkeit der Windgeschwindigkeit, kann man aus der untenstehenden Tabelle ersehen. Grundlage hierfür sind die, in den einzelnen Tabellen angegebenen Werte, welche den Einfluss des Windes nicht berücksichtigen. Um eine Flächendeckung auch bei Wind zu haben, ist deshalb dessen Einfluss unbedingt zu berücksichtigen.

Wind km/h	Regnerabstand im ▲ u. ■ reduzieren um m in %	Berechnete Fläche im ▲ u. ■ vermindert sich um:	Niederschlagshöhe erhöht sich im ▲ u. ■ um:
0 - 3	- 8%	- 16%	+ 16%
3 - 7	- 14%	- 28%	+ 28%
7 - 10	- 20%	- 40%	+ 40%
über 10	- 30%	- 60%	+ 60%

**N.B.:** Die technischen Daten auf diesem Blatt sind allgemeine Erfahrungswerte, welche durch besondere Gegebenheiten, Veränderungen unterworfen sind.

Alle Angaben haben informativen Charakter, deshalb ohne Gewähr.



## Limited warranty and disclaimer

The following constitutes the full and complete limited warranty provided by Komet Austria GmbH ("Komet") in relation to its products. This limited warranty is in lieu of any and all other warranties, express or implied, including, but not limited to, any implied warranties of merchantability or fitness for particular purposes. No person or entity is authorized to incur or assume for Komet any other expense, obligation or duty as to products designed, manufactured and/or distributed by Komet.

So long as they are used under normal working conditions and in compliance with the manufacturer's working specifications and maintenance instructions, all products distributed by Komet are warranted to be free of defects in material and workmanship for a period of one year from the date of the product's original shipment. Normal wear and tear arising from operation, damages due to improper or inadequate maintenance and damages due to presence of sand or mud and due to oxidation or any other chemical processes are specifically excluded from this limited

warranty. This limited warranty does not apply to any product that has been altered in any way. Komet undertakes, at its unquestionable judgement, to replace or repair free of charge those parts of the apparatus that proved to be faulty, providing that they are returned shipping charges prepaid. The exclusive and sole remedy with respect to above provisions is expressly limited to the repair or replacement of the part deemed to be faulty. Komet shall not be liable for any crop damages, any direct, consequential or incidental damages to persons or things resulting from any use of Komet's products.

Komet reserves the right, at any time without notice, to alter or modify its products if deemed appropriate or necessary. Illustrations and instructions are for information purposes only and are not binding in any way. Any variations to the above provisions shall be accepted only if defined and confirmed in writing by Komet. In case a legal dispute should arise, the place of jurisdiction is the Court of Lienz/Austria.







**Komet Austria GmbH**

Julius Durst Str. 10  
9900 Lienz/Austria  
Ph. (+43) 4852 71550 500  
Fax. (+43) 4852 71550 550  
komet@kometirrigation.com  
www.kometirrigation.com

Rif. 381 ED. Z16/07 - ...

© Copyright 2016 Komet Austria GmbH

All data, indications and illustrations are only informative and are subject to change at any time without previous notice and without incurring obligation. Alle Angaben und Abbildungen in diesem Prospekt haben informativen Charakter. Änderungen jederzeit ohne Voranmeldung vorbehalten.



## **EXHIBIT E**

**EXHIBIT E**

**SNOWMAKING SYSTEMS AND EQUIPMENT**

**FOR MORE INFORMATION:**

<https://www.technoalpin.com/en/>





WASTEWATER SNOWMAKING



SNOWMAKING EQUIPMENT



# SMI GRIZZLY STICK

The Grizzly is SMI's newest low energy stick and an excellent performer in all temperature conditions.

Utilizing SMI's custom 5 jet nucleation technology and angled head design, the Grizzly creates extra hangtime and powerful throw, creating better snow quality for your conditions.

The Grizzly's 4 step water adjustment is simple and easy to use with SMI's Revolver Valve on manual equipment or an intelligent automatic valve at the tail of the stick.

The Grizzly also comes with an easy to access water filter and pressure gauge. Air and water flows are customized for your resort and configured based on your local weather and snowmaking goals.

The Grizzly is simple to operate, maintain and an excellent performer. A great addition to your LowE fleet. Contact your local SMI Representative for more information.



# GRIZZLY STICK HIGHLIGHTS

## 1. HEAD

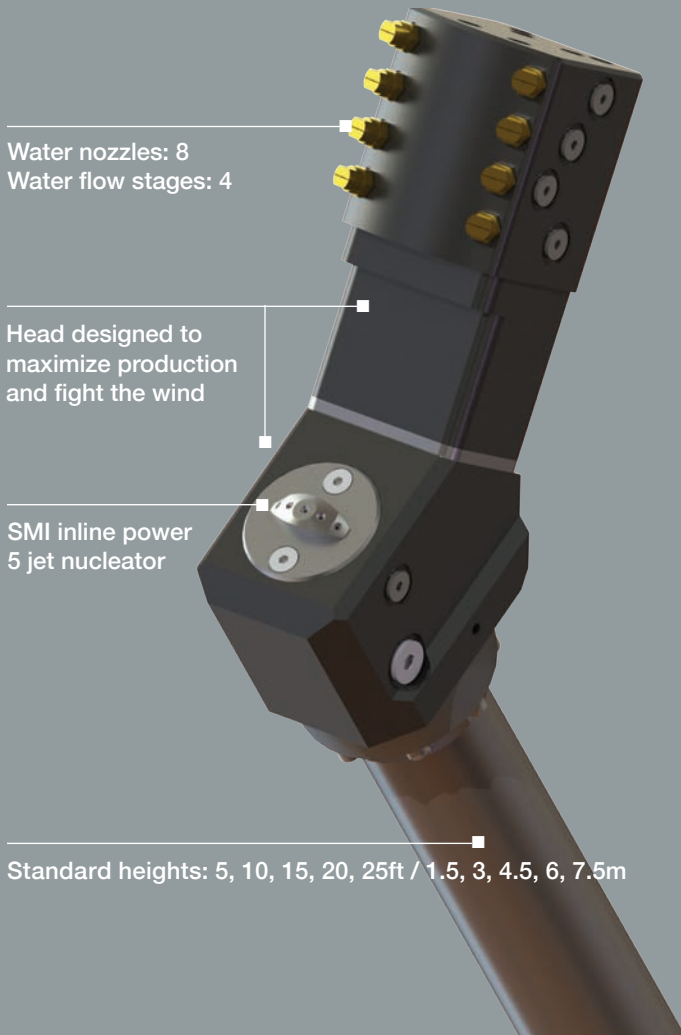

Water nozzles: 8  
Water flow stages: 4

Head designed to maximize production and fight the wind

SMI inline power 5 jet nucleator

Standard heights: 5, 10, 15, 20, 25ft / 1.5, 3, 4.5, 6, 7.5m

## 2. MANUAL REVOLVER VALVE

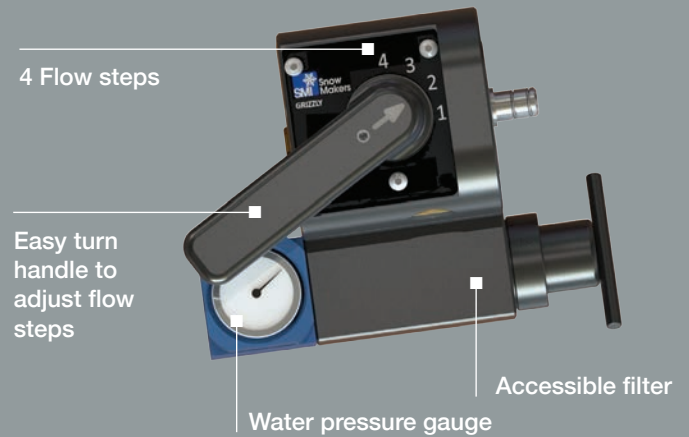

4 Flow steps

Easy turn handle to adjust flow steps

Water pressure gauge

Accessible filter

## 3. AUTO VALVE OPTIONS

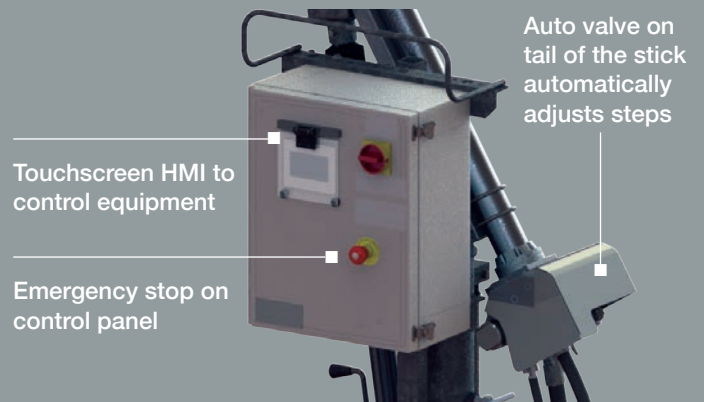

Touchscreen HMI to control equipment

Emergency stop on control panel

Auto valve on tail of the stick automatically adjusts steps

## CONFIGURATION OPTIONS

- Mounts: Base tube, vault, sled, 2-wheel cart
- Air: Hill Air (CFM Range from 8 to 120 CFM/ 226 to 3,400 LPM) or On-Board Compressor
- Controls: Manual or Automated

## AUTO HYDRANT ACTUATOR OPTIONS

- Hydrant Actuator for above ground hydrant. SMI automated pit valve for vault.
- Communication options: standalone, hardwire or radio
- Optional onboard weather
- Optional SmartSnow integration

Snow Machines, Inc. 1512 North Rockwell Dr. Midland, MI 48642 Tel: +1-989-631-6091 Toll Free: +1-800-248-6600 snowmakers.com



## TECHNICAL SPECIFICATIONS

- 10.5' (3.2 m) and 15.5' (4.5m) towers or 3-wheel galvanized carriage, and 25' (8 m) swing arm
- Electrical: 3-phase
- Super Puma Fan: 25 HP (19 Kw)  
Standard Puma Fan: 15 to 20 HP (11-15 Kw)  
Propeller: SMI custom aluminum  
Screen: stainless steel
- Compressor: 5 or 10 HP  
(4 or 7.5 Kw) Rotary Vane
- Heating: 500 to 2,500 Watts
- Water Flow: 10-130 gpm  
(40-500 lpm)
- Water Pressure: 150-1000 psi  
(10-63 Bar)
- Water Connection: Customer choice
- Valves: Five self draining heated 3-way valves
- Nucleators: Periphery with 27 nozzles
- Filtration System: Stainless steel filter with washable 30 mesh screen
- Electrical Cord: Tower 30' (10 m)  
Carriage 100' (30 m)
- Rotation: 360° horizontal rotation, -10° to 60° elevation adjustment
- Oscillator: Included as standard for 359° rotation with programmable arcs



Snow Machines, Inc.  
512 North Rockwell Dr.  
Midland, MI 48642  
USA Toll free: +1.800.248.6600  
International: +1.989.631.6091  
snowmakers.com

# PUMA

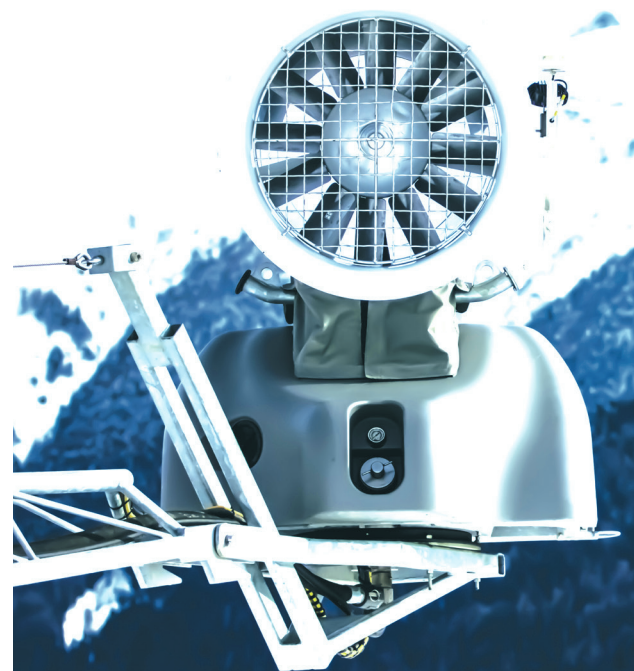



# king of the mountain



## THE PUMA SERIES

The Puma and Super Puma Snowmakers have been developed with input from customers, service technicians and sales reps, worldwide, with a goal of maximizing production over a wide range of conditions, especially in marginal temperatures. The Puma was designed to interface with automation and control software for optimum performance in any snowmaking weather. It is equipped with an on-board aspirated weather station, air and water pressure monitoring, and automated flow control. The small flow steps deliver a smooth snowmaking curve, fine-tuning the water volume, air pressure and nucleation to best suit constantly changing weather conditions.

Each unit employs a convenient touch-screen panel at eye level for manual control when desired, and the Puma can be configured to communicate with a central computer via hardwire (copper, CAT 5 Ethernet or fiber optic), or by radio. The machine is well-suited to central intelligence (a single computer or control room for all snowguns) or distributed intelligence

(some type of computer to manage each snowgun, pod or ski trail).

Thanks to the Puma's level of automation, operators can raise and lower the barrel or adjust the oscillation arc up to 359° on any number of machines from a central command station, helping to deliver pinpoint control with minimal labor. The result is better snow distribution and reduced man hours needed for grooming.

With its low, compact center of gravity and ergonomic design, the Puma is easy to use and transport. Components are positioned to make transport via snow cat blade easy and safe, minimizing overhanging load and reducing stress on the blade. Adjustable lifting brackets accommodate all snow cat blade designs.

Like all of SMI's products, the Puma follows a philosophy of easy operation, transport and maintenance. The units are designed to be user serviceable, with readily available replacement parts.

SMI's ultimate goal is to provide equipment that allows ski resorts to open earlier in the season, with higher trail counts. The rising levels of automation in designs like the Puma help achieve that goal, and to recover more quickly from bad weather events, so you can stay open longer and offer the best snow surfaces possible.





# SMI V2 SNOWTOWER™

The low energy V2 is designed for versatility and flexible performance across a full range of temperature and wind conditions. The V2 is a four step (2 valves) stick with 12 nozzles and 2 nucleators.

Features of the V2 include: mounts in post for hill or vault, and in portable sled; on board compressor and central air feed options; light weight compo-

nents that feature tool less fasteners for easy portability; easy lift off compressor and control panel; 15 to 25 foot (4.5 to 7.5 meter) mast lengths; manual, semi automatic and fully automated options; automated on board or central weather options; and nucleator air flow ranges from 20 to 140 cfm (0.6 to 4.0 cmm).

The V2 is well packaged and simple to install and operate. The custom nucle-

ation and filter system are easy to maintain. The jack for raising and lowering the V2 is safe and easy to operate. The optional automatic valving system is a custom design that allows the extra water to simply adjust to the changing temperatures.

Call SMI or your local representative today for more information or visit us at [snowmakers.com](http://snowmakers.com).





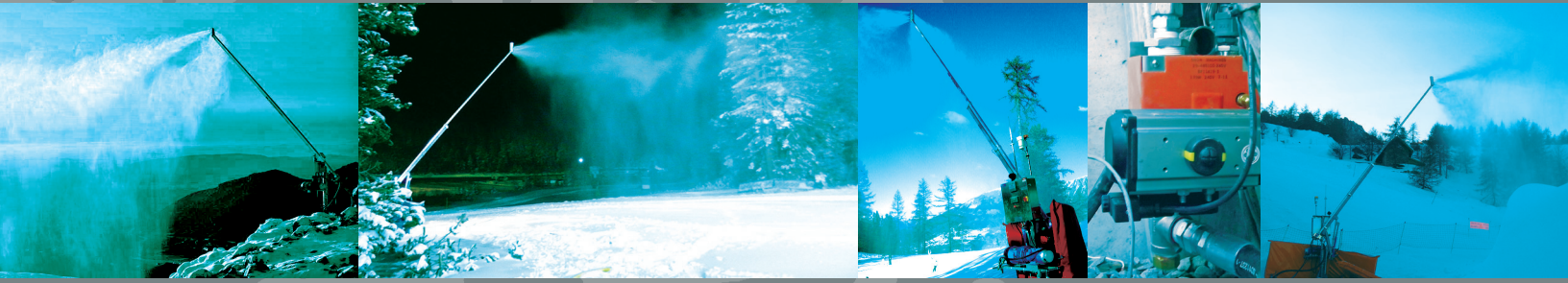

# TECHNICAL SPECIFICATIONS

## V2 FLEXIBILITY AND PERFORMANCE

The V2 SnowTower™ has many flexible automation options including remote control and full automatic modes of operation for individual standalone machines or when connected to a complete network.

SMI's SmartSnow™ Automation & Control software is flexible and customizable and offers proven communication options, accurate weather measurement, supporting equipment and instrumentation, integrated auxiliary equipment, and service that is second to none.

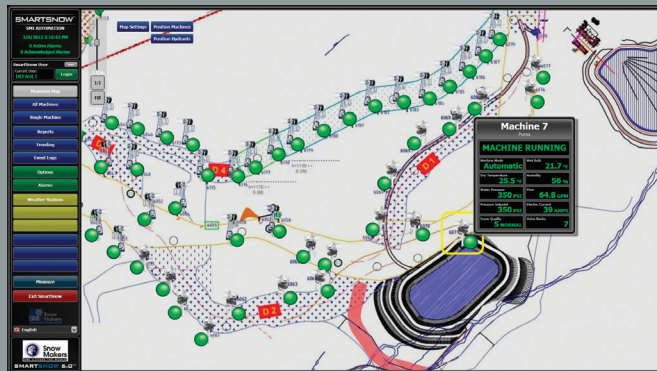

This low energy air / water stick relies on the shared accessories available in the Viking product family such as:

- i) Common vault – for direct mounting of stick (Optional covered and heated concrete vault provides base tube mounting, electrical, water, air (optional), and communication (optional) connection ports)
- ii) Common base assembly
- iii) Easy lift off components
- iv) Removable jack

- Approximate overall height: 20' (6 m) or 30' (9 m)
- Water nozzles: 12 nozzles
- Nucleation nozzles: 2 nozzles
- Air supply: minimum 20 cfm (0.57 m<sup>3</sup>/min) for hill air
- Jack: removable hydraulic with safety latch
- Boom and head assembly: aluminum
- Tower and base: galvanized steel
- Operating water pressure range: 250-870 psi (17 - 60 bar)
- Feed-through tower assembly for clean appearance
- Mount: post, vault or sled

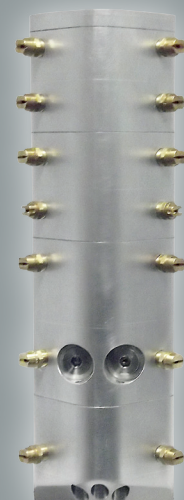

Snow Machines, Inc.  
1512 North Rockwell Dr.  
Midland, MI 48642  
Tel: +1-989-631-6091  
Toll Free: +1-800-248-6600  
snowmakers.com

STATE OF MAINE  
DEPARTMENT OF AGRICULTURE, CONSERVATION & FORESTRY  
LAND USE PLANNING COMMISSION

IN THE MATTER OF	)	Pre-Filed Direct Testimony of Mark
REZONING PETITION ZP 779A	)	Peters on Behalf of Wolfden Mt.
WOLFDEN MT. CHASE, LLC	)	Chase, LLC

On behalf of Wolfden Mt. Chase, LLC (“Wolfden”), Mark Peters is submitting this pre-filed direct testimony in support of ZP 779A.

**I. QUALIFICATIONS AND EXPERIENCE**

I am an Associate Engineer with WSP USA (formerly Wood Environment and Infrastructure (Wood)) with nearly 40 years of providing civil engineering design and technical guidance for a wide variety of projects including extensive experience and expertise in stormwater management; watershed hydrologic and hydraulic modelling; flood plain assessment and determination; and erosion and sediment control. My site/civil engineering experience includes providing detailed site development design and permitting for heavy and light manufacturing facilities, large industrial parks, shopping malls, mine sites, groundwater treatment facilities, CCR Impoundments, and landfills.

I have managed, provided senior technical review, and/or conducted detailed design for development projects, including preparation of construction drawings, technical specifications, bid documents, and permit documents. Throughout my career, I have been involved with the local, state, and federal regulatory permitting and licensing activities required for many projects in over a dozen different states. My permitting experience includes preparation of required documents for National Pollutant Discharge Elimination Systems (NPDES) permits, including stormwater pollution prevention plans, erosion and sediment control plans, post-construction



stormwater management plans, and all supporting calculations for sizing of permanent water collection systems, best management practices for permanent stormwater management for quality and quantity standards, and temporary erosion and sediment control measures. In addition, I have extensive experience conducting flood plain evaluations including watershed analyses and stream and river modelling for determining flood water surface elevations.

WSP Global is a globally recognized professional services firm providing strategic advisory, engineering, and design services to clients in the transportation, infrastructure, environment, building, power, energy, water, and resource sectors. Wood was purchased by WSP in September of 2022, and WSP USA (WSP) is the United States (US) operating company of WSP Global with a national network of 10,000+ staff in 200 offices. WSP has a local presence in Maine with an office located at 511 Congress Street Portland, Maine. The Maine office started as the former E.C. Jordan Company in 1873, 150 years ago. The Portland office is a full-service engineering, consulting, and architectural design firm that houses over 148 professionals with experience in preparing detailed designs and environmental reports; performing construction management; survey, civil, geotechnical, environmental engineering; subsurface utility engineering; construction inspection and materials testing; and environmental permitting services.

I am a licensed professional engineer and am currently a team leader for a group of civil engineers and civil designers within the Portland, Maine design center.

My curriculum vitae is attached as Exhibit A.

## **II. INVOLVEMENT WITH THE PICKETT MOUNTAIN PROJECT**

WSP was retained by Wolfden to develop the water collection system, specifically the preliminary sizing and design of the pre-treatment water storage pond associated with

stormwater runoff and melting snow from mine facilities potentially impacted with contaminants from the mine activities. In addition, a base water flow of 30 gallons per minute (gpm) from dewatering the mine is included in the total volume of water to be collected and stored for treatment. As discussed in the expert reports and pre-filed testimony of MWS and SME, collected surface and mine water that may be potentially contaminated from mine activities will be treated to appropriate background water quality standards and then returned to the environment in a manner to maintain the existing site hydrology. Our work focused on the preliminary sizing of the system for storing collected surface water that potentially comes into contact with mining material and mine water so that it can be treated. Our report on the surface water collection system is Attachment 10-C to the application and is attached here as Exhibit B.

### III. SURFACE WATER COLLECTION SYSTEM

#### A. Overview of the System

The Pickett project includes a number of mine facilities where stormwater runoff or melting snow is in potential contact with mining activities. This includes the mine facilities listed below:

**Summary of Precipitation Runoff Collection Areas for Storage and Treatment**

<b>Map ID</b>	<b>Facility Name</b>	<b>Facility Area (Ac) <sup>(1)</sup></b>
2	Low Grade Ore Storage Pad	5.276
3	Snow Storage	2.579
4	Pre-Treatment Water Storage Pond	2.818
14	Offices and Mine rescue Facility	0.214
15	Core Shack and Storage	0.099
17	Maintenance Shop	0.110
18	Equipment Fueling Station	0.042
20	Waste Rock Storage Pad #1	3.591
21	Backfill Plant	0.334
22	Ore (Mill Feed) Storage Pad #1	1.259
23	Blast Shack	0.023
24	Mine Access (Portal)	0.385
28	Headframe and Hoist	0.071
29	Ore (Mill Feed) Storage Pad #2	1.016
30	Waste Rock Pad #2	1.016

35	Site Mine Roads	2.368
--	Area Surrounding Mine Facilities <sup>(2)</sup>	7.188
	<b>Total</b>	<b>28.389</b>

(1) Areas taken from the conceptual mine layout provided on Figure 1 (Attachment 1).

(2) Includes the areas immediately adjacent to mine facilities listed in the table that will be within the runoff collection area including the pond surrounding berm.

The total mine site drainage area to be collected and treated is approximately 28.39 acres.

The mine facilities and areas where runoff will be collected, as summarized in the table, includes the Map ID and Facility Name that is provided on Figure 2 of the report, as well as the facility area in acres. Proposed facilities providing support to the mine operations where precipitation runoff will not be collected and treated in the water treatment plant were not part of the evaluation discussed in Attachment 10-C to the application. Stormwater runoff from these areas including the employee parking area, warehouses, and solar facility will be managed with appropriate stormwater best management practices in accordance with Maine Stormwater Best Management Practices Manual and 06-096 C.M.R. Chapter 500: Stormwater Management.

Surface water runoff that is potentially impacted by mining activities is collected and, along with mine water, is stored and then treated and returned to the environment. The purpose of the collection is to ensure that water potentially contaminated by mine activities is collected for retention and subsequent treatment. The water collection infrastructure from the designated mine facilities to convey surface water to the retention areas will likely consist of several systems, including containment pads with collection sumps; collection trenches, catch basins and gravity piping; and pumps and forcemain piping. The final water collection and storage system design will reflect the site-specific data to be collected as part of the Chapter 200 process.

**B. Analysis in Support of System Sizing**

A stormwater analysis was conducted for the purpose of determining the estimated volume of precipitation runoff and mine dewatering to be collected, stored and treated. The

surface water volumes were determined based on the acreage of the three discrete collection areas. These areas are shown on Figure 2 of my report and listed in Table 1 of my report. The stormwater analysis was conducted by developing a stormwater model using commercially available computer software based upon the United States Department of Agriculture Technical Release 20 (TR-20) methodology. The TR-20 method is a standard engineering method used to evaluate runoff conditions and develop appropriate stormwater controls and management systems. Importantly, the system design reflects the following parameters and assumptions.

The Pre-Treatment Storage Pond is sized to accommodate surface water associated with a 500-year, 24-hour storm event in accordance with the requirements of Chapter 200. The volume of runoff water associated with 500-year, 24-hour storm event collected from the designated mine facilities is 5.07 mgal. In addition, when evaluating the capacity needs for the Pre-Treatment Storage Pond we took into account mine dewatering, which is estimated to be 30 gallons per minute or 43,200 gallons during a 24-hour period. The total volume requiring storage is 5.11 million gallons (mgal). The Pre-Treatment Storage Pond has a design storage volume of 6.87 mgal at two feet below the top of the pond berm (2-feet of freeboard), which provides an additional approximate 34% storage capacity over what would be required in a 500-year storm event. It is also assumed that no discharge from the pond occurs during the design storm event and there is a minimum two feet between the highest water level and top of the pond/embankment (referred to as freeboard). The 2-foot freeboard provides additional storage contingency of approximately 1.08 mgal (total pond volume of 7.95 mgal).

The peak average monthly volume of water to be collected and stored was also evaluated based on average monthly precipitation data from Patten, Maine, adjusted to take into account months when precipitation combined with snow melt is highest (e.g., April and May). The month



with the highest average runoff volumes is April, which would result in a typical runoff volume of approximately 5.28 million gallons (an average of 122 gpm) that would be collected and stored prior to treatment, with a total monthly volume of 6.57 mgal (an average of 152 gpm) when including the mine dewatering volume. Many of the other months have on average significantly less precipitation and therefore less surface runoff. For example, February averages only 1.38 million gallons (an average of 34 gpm). The 205 gpm that is used by MSE in the water treatment system minimum capacity includes the April 6.57 mg volume converted from a monthly total to an average gpm treatment rate plus an approximate 53 gpm or 35% contingency (205 gpm treatment rate – 152 gpm average rate for April). Also, the average peak monthly volume is more relevant to the water treatment system sizing and less relevant to the pond volume sizing. It is the 500-year storm event that dictates that pond volume sizing, and that sizing is more than sufficient to accommodate the volumes that will be generated during routine operations, including taking into account mine process water that is directed to the Pre-Treatment Water Storage Pond and then recycled for use in the mine.

In summary, the total volume of the Pre-Treatment Water Storage Pond is 7.95 mgal; an additional storage volume (rough order of magnitude of 1.6 mgal) would be included in the collection system (containment pads, sumps, trenches, piping); as a contingency measure, water can be pumped back into the mine for temporary storage. In addition, up to 7 mgal of storage may be available if needed in the Post-Treatment Water Storage Pond.

The final sizing of the Pre-Treatment Water Storage Pond will be based on site-specific data (detailed topographic surveys, geotechnical investigations, and final layout of mine facilities) to be collected as part of the Chapter 200 process that will further inform sizing of the storage pond.

I appreciate the opportunity to provide this information and to answer questions from the Commission, staff and parties at the public hearing.

Dated: 9/21/2023

Mark Peters

Mark Peters

STATE OF MAINE

County of: Cumberland

Date: 9/21/2023

Personally appeared before me the above named Mark Peters, who, being duly sworn, did testify that the foregoing testimony was true and correct to the best of his knowledge and belief.

Before me,

Suzette M. SASS

Notary Public

My commission expires: 1-28-28

**SUZETTE M. SASS**  
Notary Public, State of Maine  
My Commission Expires Jan. 28, 2028

# **EXHIBIT A**





### *BACKGROUND*

Mr. Peters is an Associate Engineer with WSP USA (formerly Wood Environment and Infrastructure [Wood]) with nearly 40 years of providing civil engineering design and technical guidance for a wide variety of projects including extensive experience and expertise in stormwater management; watershed hydrologic and hydraulic modelling; flood plain assessment and determination; and erosion and sediment control. His site/civil engineering experience includes providing detailed site development design and permitting for heavy and light manufacturing facilities, large industrial parks, shopping malls, mine sites, groundwater treatment facilities, CCR Impoundments, and landfills.

### *AREAS OF EXPERTISE*

- Stormwater management/erosion control
- Stormwater Pollution Prevention Plans (SWPPP)
- Hydrology and hydraulic engineering
- Site Development
- Technical specifications
- Design drawings
- Value engineering
- Infrastructure/utility design
- CAD production/computer modelling
- Remedial design
- Landfill, lagoons, and mine closure/design.

### *EDUCATION*

Master of Science, Civil Engineering, University of New Hampshire - 1984

Bachelor of Science, Civil Engineering, University of New Hampshire - 1982

### *PROFESSIONAL REGISTRATIONS*

Professional Engineer, ME, 6631

Professional Engineer, VT, 7055

Professional Engineer, NH, 7154

Professional Engineer, MA, 35251

### *TRAININGS*

Proficient in HEC-RAS

Proficient in HEC-HMS

Proficient with HydroCAD®



MARK A. PETERS, PE  
*Associate Civil Engineer*

---

Proficient with PCASE

Proficient with HELP

Skilled with AutoDesk® Storm and Sanitary Sewer Analysis

Skilled with AutoCAD® 2D and CIVIL3D

### *EMPLOYMENT HISTORY*

#### **WSP Environment & Infrastructure Inc., Portland, ME, 1990 – Ongoing:**

Mr. Peters is an Associate Engineer providing civil engineering design and technical guidance for a wide variety of projects including extensive experience and expertise in civil/site development; stormwater management and watershed hydrologic modelling; flood plain assessment and determination; and stormwater management permitting and erosion and sediment control. His site/civil engineering experience includes providing detailed site development design and permitting for large industrial, commercial, institutional, and remediation projects, as well as road/highway design throughout the country. These development projects include heavy and light manufacturing facilities, large industrial parks, shopping malls, office complexes, schools, groundwater treatment facilities, and landfills. As an Associate Engineer, Mr. Peters is responsible for quality assurance and technical content for assigned site/civil projects. Mr. Peters is also currently a team leader for a group of civil engineers within the Portland, Maine design center.

#### **Civilworks, Inc., Dover, New Hampshire, 1987 – 1990:**

Provided design, permitting, and construction inspection for a variety of site development projects including, industrial, commercial/retail, institutional/municipal, residential, and gravel pit mining. Coordinated and designed all aspects for assigned development projects including developing site layouts; design of roadways and parking lots; gas, electric, communication, water and sewer utilities; stormwater management and erosion and sediment control; wetland impacts and mitigation; obtaining local approvals and state and federal regulatory permits.

#### **Civil Designs, Inc., Boston, Massachusetts, 1984-1987:**

Provided design, permitting, and construction inspection for primarily large industrial and residential subdivisions. Conducted field topographic surveys, soil investigations and provided detailed designed for all aspects for assigned development projects including developing site layouts; design of roadways and parking lots; gas, electric, communication, water and sewer utilities; stormwater management and erosion and sediment control; wetland impacts and mitigation; obtaining local approvals and state and federal regulatory permits.

#### **U.S. Forest Service, Northeast Region Research Station, Durham, New Hampshire, 1982-1984:**

As master's degree research, was provided a grant from the U.S. Forest Service for the comprehensive study on the Structural Failure of Living Balsam Fir Trees with Decay and Cracking Patterns. The research involved strength testing of green wood samples in a



MARK A. PETERS, PE

*Associate Civil Engineer*

---

laboratory, developing and implementing a field test procedure for loading living trees to failure, and developing a mathematical/computer model using finite difference analysis to predict tree failure during wind loading. Authored thesis on findings and published two articles in scientific journals on this topic.

*PUBLICATIONS*

1986. "Potential Failure of a Decayed Tree Under Wind Loading," Wood and Fiber Science, Vol. 18, No. 1, January (with Paul Ossenbruggen and Alex Shigo).

1985. "Cracking and Failure Behavior Models of Defective Balsam Fir Trees," Holzforschung, Bd. 39, H. 3 (with Paul Ossenbruggen and Alex Shigo)

## **EXHIBIT B**



## TECHNICAL MEMORANDUM

**DATE:** May 23, 2022  
Revised August 25, 2022

**TO:** Project File

**FROM:** Mark Peters, P.E.

**REVIEWED BY:** Kyle Cunniff

**SUBJECT:** Proposed Pickett Mountain Mine Project Precipitation  
Runoff Collection Areas - Mine Only Option

**PROJECT:** 3617227547

---

### 1.0 INTRODUCTION

The proposed mine operation includes a number of mine facilities where stormwater runoff or melting snow could be impacted with contaminants from the mine activities. The mine operations will include measures to collection and treat stormwater and snow melt runoff from these facilities to prevent impact to downgradient surface water or underlying groundwater. In addition, a base water flow of 30 gallons per minute (gpm) from dewatering the mine is included in the total volume of water to be collected and stored for treatment. This technical memorandum provides a description of the approach to calculate the estimated volume of precipitation runoff and mine dewatering to be collected and treated. Runoff from specific identified mine facilities and water from mine dewatering will be collected in a Pre-Treatment Water Storage Pond prior to treatment. Preliminary sizing of the Pre-Treatment Water Storage Pond based on the calculated runoff volume from a 500-year design storm event and mine dewatering, as well as typical monthly runoff volumes for treatment are provided in this memorandum.

Proposed facilities providing support to the mine operations where precipitation runoff will not be collected and treated in the water treatment plant is not part of this evaluation discussed in this technical memorandum. Stormwater runoff from these areas including the employee parking area, warehouses, and solar facility will be managed with appropriate stormwater best management practices in accordance with Maine Stormwater Best Management Practices Manual and 06-096 C.M.R. Chapter 500: Stormwater Management.

### 2.0 APPROACH

A stormwater analysis was conducted that included delineating drainage areas for the proposed mine facilities where precipitation runoff will be collected and treated. The proposed mine layout with drainage areas is provided on Figure 1, the Proposed Condition Watershed (Attachment 1). The subcatchments where precipitation runoff will be collected for treatment include:

- Drainage Area DA-6A: Approximately 3.25 acres consisting of the Pre-Treatment Water Storage Pond and surrounding embankment that will receive direct precipitation from storm events that



needs to be included in the treatment and storage volume.

- Drainage Area DA-7A: Approximately 22.17 acres consisting of the Phase I primary mine facilities including ore and waste rock pads, Backfill Plant, Mine Access (portal), mine roads and other associated facilities.
- Drainage Area D-13A: Approximately 2.97 acres consisting of Phase II mine facilities that include pads for ore and waste rock and a headframe and hoist.

The total drainage area to be collected and treated is approximately 28.39 acres. The mine facilities and areas where runoff will be collected are summarized in Table 1. The table includes the Map ID and Facility Name that is provided on Figure 1 as well as the facility area in acres and the runoff curve number (CN) used in the stormwater analysis. The CN is based on the cover type as well as the soil type. The primary soil type within the area of the mine facility development is classified as hydrologic soil group (HSG) C which is somewhat poorly drained. Detailed soil descriptions are provided in Exhibit 23. Runoff curve numbers used in the modeling for HSG C and the proposed cover type include CN = 98 for buildings, structures and ponds (impervious) and CN = 96 for pads and gravel areas (also impervious but with some minor retention in voids of the ore, rock, and gravel). In addition, mine drainage areas include areas immediately adjacent to mine facilities that will be within the runoff collection area. These surrounding areas have been assumed to be poorly vegetated and assigned a CN of 86.

**Table 1 – Summary of Precipitation Runoff Collection Areas**

<b>Map ID</b>	<b>Facility Name</b>	<b>Facility Area (Ac) <sup>(2)</sup></b>	<b>Runoff Curve Number CN</b>
2	Low Grade Ore Storage Pad	5.276	96
3	Snow Storage	2.579	96
4	Pre-Treatment Water Storage Pond	2.818	98
14	Offices and Mine rescue Facility	0.214	98
15	Core Shack and Storage	0.099	98
17	Maintenance Shop	0.110	98
18	Equipment Fueling Station	0.042	98
20	Waste Rock Storage Pad #1	3.591	96
21	Backfill Plant	0.334	96
22	Ore (Mill Feed) Storage Pad #1	1.259	96
23	Blast Shack	0.023	98
24	Mine Access (Portal)	0.385	98
28	Headframe and Hoist	0.071	98
29	Ore (Mill Feed) Storage Pad #2	1.016	96
30	Waste Rock Pad #2	1.016	96
35	Site Mine Roads	2.368	96
--	Area Surrounding Mine Facilities <sup>(1)</sup>	7.188	86
	<b>Total</b>	<b>28.389</b>	<b>94</b>

(1) Includes the areas immediately adjacent to mine facilities listed in the table that will be within the runoff collection area including the pond surrounding berm.

(2) Areas taken from the conceptual mine layout provided on Figure 1 (Attachment 1).

The stormwater analysis was conducted by developing a stormwater model using commercially available computer software based upon the United States Department of Agriculture Technical Release 20 (TR-20) methodology. The TR-20 method is a standard engineering method used to evaluate runoff



conditions and develop stormwater controls. HydroCAD® by Applied Microcomputer Systems, Inc, a stormwater modeling software which uses the TR-20 method, combined with the standard hydraulic equations, was used to for development and evaluation of the stormwater models and drainage systems.

The design for the collection, storage and treatment of surface water runoff from the identified mine facilities is based on the following design parameters and assumptions:

Pre-Treatment Pond Sizing:

- Peak Pond Storage Design Storm: Total runoff volume from a 500-year, 24-hour storm event in accordance with 06-096 Chapter 200: Metallic Mineral Exploration, Advanced Exploration and Mining. Using precipitation data taken from NOAA Atlas 14, Volume 10, Version 3, the 500-year, 24-hour is 7.82 inches of precipitation for the mine site (Attachment 2).
- Mine Dewatering: A base water flow of 30 gallons per minute (gpm) from dewatering the mine is included in the total volume of water to be collected and stored for treatment. Seepage of bedrock water as well as the use of water during the mining process, necessitates constant mine dewatering. Although engineering/hydrologic studies have not been conducted to quantify flow rates required to keep the working areas of the mine in a dewatered state, it is currently estimated based on similar site experience and the likelihood of low transmissivity bedrock at depth, that these “seepage” flows are likely to be on the order of 30 gallons per minute (gpm) long term.
- For the Pre-Treatment Water Storage Pond sizing it is assumed that no discharge from the pond for treatment occurs during the design storm event.
- A minimum 2-foot freeboard from the stored water elevation to the top of the pond berm/embankment was used for calculating the required Pre-Treatment Water Storage Pond volume.

Peak Monthly Treatment Volume:

- Average Monthly Precipitation: Average monthly precipitation data was obtained for Patten, Maine from the U.S. Climate Data website (Attachment 3). The monthly precipitation was input into the HydroCAD® model to get an estimated monthly runoff volume.
- The monthly runoff volume was adjusted using an estimated factor for seasonal temperature affects to account for ice and snow precipitation that buildups in the winter months and then melts in the early spring months. The temperature/seasonal adjustment factors were estimated by reviewing historical mean daily discharge data for a gauge located on the Seboeis River located approximately 8.5 miles west of the mine site (Attachment 4). The discharge data shows a significant increase in stream flow for the months of April and May.
- The estimated monthly runoff volume for the months of April and May were increased by a temperature/seasonal adjustment factor of 2.3 and 1.6, respectively to provide an estimated typical peak monthly runoff volume for treatment.
- The monthly runoff volume includes the 30-gpm mine dewatering volume.

### 3.0 RESULTS

The HydroCAD® model provides the following results for the Pre-Treatment Pond storage volume and the typical monthly treatment volumes:

Pre-Treatment Pond Storage:



- Collected water volume = approximately 5.11 million gallons (mgal) for a 500-year, Type III 24- hour storm event (volume includes 30 gpm for mine dewatering).
- Required pond volume with a minimum 2-foot freeboard = approximately 6.87 mgal.
- The area shown for the Pre-Treatment Water Storage Pond on Figure 1 (Map ID 4) is adequate for the pond footprint and provides the required volume with a water depth of 6.75 feet and top of pond at 8.75 feet.

To verify the adequacy of the 2-foot freeboard, the model was run for the 500-year storm event assuming both a saturated soil condition and a frozen surface condition. The results show that an approximate 1.5-foot freeboard is maintained for these two soil conditions. In addition to the 500-year design storm event water treatment volume, Table 2 below provides collected runoff volumes for other storm events.

**Table 2 – Summary of Precipitation Runoff Treatment Volumes by Storm Event**

Storm Event (yr.)	Collected Volume (gal)	Collected Volume (cf)
1	1,367,449	182,814
2	1,658,009	221,659
5	2,156,132	288,253
10	2,559,836	342,224
25	3,120,873	417,229
50	3,547,375	474,248
100	3,981,050	532,226
500	5,110,433	683,213

Peak Monthly Treatment Volume:

Table 3 provides a summary of the estimated typical monthly runoff volume collected for treatment

**Table 3 - Monthly Runoff Treatment Volumes**

Jan	Feb	Mar	Apr	May	Jun	Jul	Aug	Sept	Oct	Nov	Dec
<b>Average Precipitation in Inches</b>											
3.28	2.57	3.07	3.85	4.02	3.81	4.08	3.99	4.02	4.27	4.38	3.69
<b>Runoff Volume in Million Gallons</b>											
2.22	1.72	2.07	2.29	2.41	2.26	2.45	2.39	2.41	2.59	2.67	2.51
<b>Assumed Runoff Factor Due to Temperature</b>											
0.15	0.10	0.70	2.30	1.60	1.00	1.00	1.00	1.00	1.00	0.95	0.90
<b>Estimated Runoff Volume Adjusted for Temperature in Million Gallons</b>											
0.33	0.17	1.45	5.28	3.87	2.26	2.45	2.39	2.41	2.59	2.54	2.26
<b>30 GPM Mine Dewatering Monthly Volume in Million Gallons</b>											
1.34	1.21	1.34	1.30	1.34	1.30	1.34	1.34	1.30	1.30	1.30	1.34
<b>Total Monthly Treatment Volume in Million Gallons</b>											
1.67	1.38	2.79	6.57	5.20	3.56	3.79	3.73	3.71	3.89	3.84	3.60

Blue: Winter Months - frozen conditions with reduced runoff.

Grey/Blue: Late Fall-Early Winter or Late Winter- Early Spring - some reduced runoff.

Green: Spring months - increased runoff with snow melt.





#### 4.0 ATTACHMENTS

1. Attachment 1: Figure 1 - Proposed Watershed Conditions
2. Attachment 2: Precipitation Data - NOAA Atlas 14, Volume 10, Version 3
3. Attachment 3: Average Monthly Precipitation Data
4. Attachment 4: Seboeis River Gauge Discharge Data
3. Attachment 5: HydroCAD® Model Output - 500-year, 24-hour Storm Event

#### 5.0 REFERENCES

1. Applied Microcomputer Systems, HydroCAD® Stormwater Modeling System Owner's Manual, 2020
2. NOAA Atlas 14, Volume 10, Version 3
3. U.S. Weather Service - [www.usclimatedata.com/climate/patten/maine/united-states](http://www.usclimatedata.com/climate/patten/maine/united-states)
4. U.S. Geological Survey - [nwis.waterdata.usgs.gov/me/nwis](http://nwis.waterdata.usgs.gov/me/nwis)
5. Rezone Petition Exhibit 23 – Soil Suitability
6. 06-096 C.M.R. Chapter 200: Metallic Mineral Exploration, Advanced Exploration and Mining
7. 06-096 C.M.R. Chapter 500: Stormwater Management



**Attachment 1:**  
**Figure 1 - Proposed Condition Watershed**





Map ID	Facility Name
1	SOLAR FACILITY (APPROX)
2	LOW GRADE ORE STORAGE PAD
3	SNOW STORAGE
4	PRE-TREATMENT WATER STORAGE POND
5	WATER TREATMENT FACILITY
6	ELECTRICAL SUBSTATION
7	BACK-UP POWER GENERATION (DIESEL OR PROPANE)
8	POST-TREATMENT WATER STORAGE POND
9	INFILTRATION GALLERY #1
10	FIRE WATER PUMPHOUSE
11	SANITARY SUBSURFACE DISPOSAL SYSTEM
12	PARKING FACILITY
13	WAREHOUSE
14	OFFICES AND MINE RESCUE FACILITY
15	CORE SHACK AND STORAGE
16	LAYDOWN (EQUIPMENT/SUPPLIES STORAGE)
17	MAINTENANCE SHOP
18	EQUIPMENT FUELING STATION
19	INFILTRATION GALLERY #2
20	WASTE ROCK STORAGE PAD #1
21	BACKFILL PLANT
22	ORE (MILL FEED) STORAGE PAD #1
23	BLAST SHACK
24	MINE ACCESS (PORTAL)
25	EAST VENTILATION RAISE
26	ORGANICS STORAGE
27	INFILTRATION GALLERY #3
28	HEADFRAME AND HOIST
29	ORE (MILL FEED) STORAGE PAD #2
30	WASTE ROCK PAD #2
31	TEMPORARY EXPLOSIVES STORAGE
32	WEST VENTILATION RAISE
33	INFILTRATION GALLERY #4
34	EXISTING SITE ROAD
35	PROPOSED SITE ROAD
36	SECURITY GUARD HOUSE/GATE
37	SECURITY FENCING
38	INFILTRATION GALLERY #5
39	INFILTRATION GALLERY #6

**LEGEND:**

- BOUNDARY DRAINAGE
- TC FLOW PATH
- MINE FACILITY DRAINAGE AREAS WHERE PRECIPITATION RUNOFF IS COLLECTED AND TREATED
- EXISTING CONTOURS
- SOIL SERIES BOUNDARY
- STREAM
- PICKETT MOUNTAIN POND / PLEASANT LAKE WATERSHED DIVIDE
- WETLAND
- 400-FOOT REZONING SETBACK BUFFER
- PROPOSED REZONING
- VERNAL POOLS

**ABBREVIATION:**

- DA - DRAINAGE AREA
- TC - TIME OF CONCENTRATION
- CN - CURVE NUMBER
- POA - POINT OF ANALYSIS
- SF - SHEET FLOW
- SCF - SHALLOW CONCENTRATION FLOW

DRAINAGE AREA  
CURVE NUMBER  
AREA IN ACRES

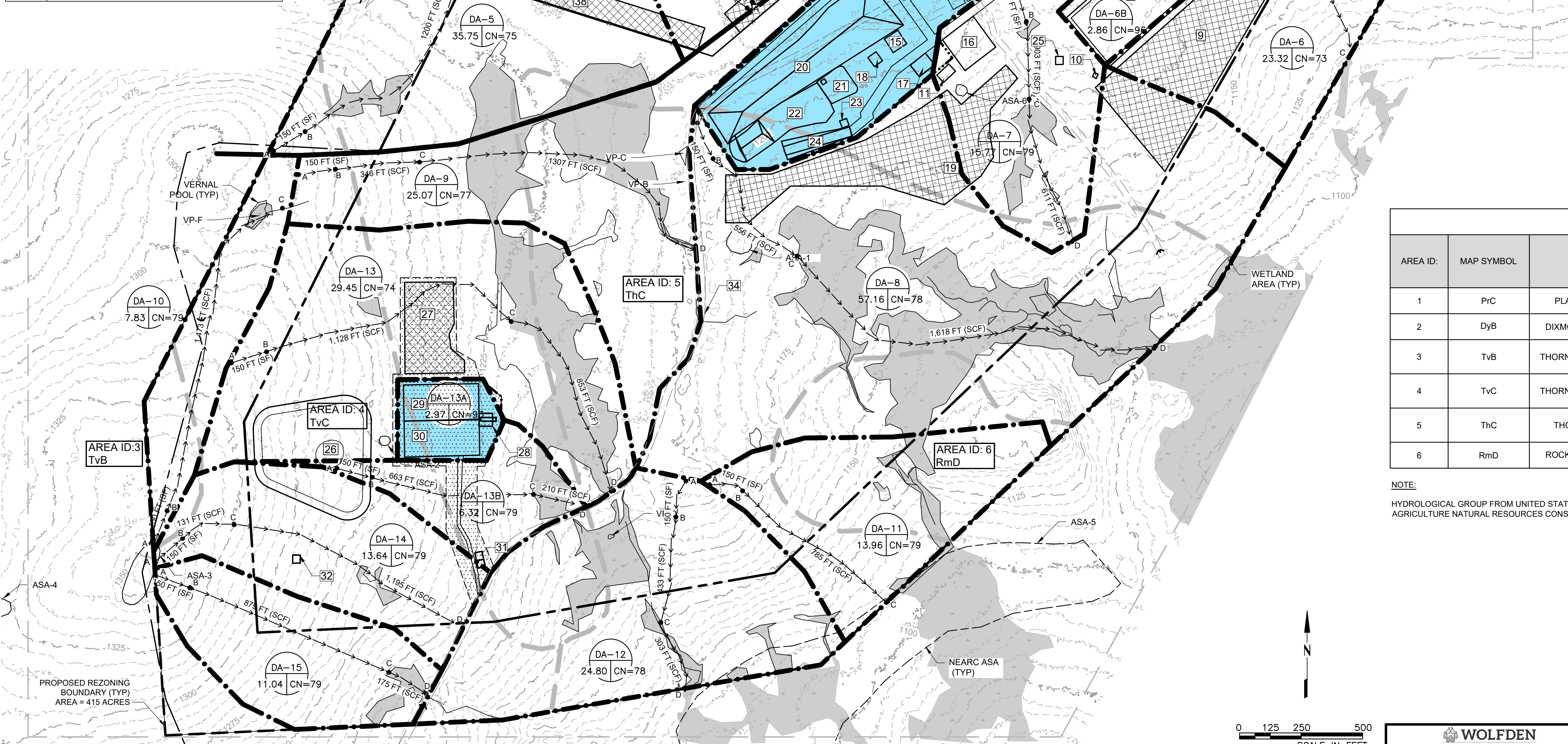

SOIL KEY					
AREA ID:	MAP SYMBOL	SOIL SERIES	DRAINAGE CONDITION	SLOPE (%)	HYDROGRAPHICAL GROUP
1	PrC	PLAISTED VERY STONY LOAM	WELL DRAINED	8-15	C
2	DyB	DIXMONT VERY STONY SILT LOAM	SOMEWHAT POORLY DRAINED	2-8	C/D
3	TvB	THORNDIKE VERY STONY SILT LOAM	SOMEWHAT EXCESSIVELY DRAINED	2-8	D
4	TvC	THORNDIKE VERY STONY SILT LOAM	SOMEWHAT EXCESSIVELY DRAINED	8-15	D
5	ThC	THORNDIKE SHALY SILT LOAM	SOMEWHAT EXCESSIVELY DRAINED	8-15	D
6	RmD	ROCKLAND, THORNDIKE MATERIA	EXCESSIVE DRAINAGE	15-25	-

**NOTE:**  
HYDROLOGICAL GROUP FROM UNITED STATES DEPARTMENT OF AGRICULTURE NATURAL RESOURCES CONSERVATION SERVICE

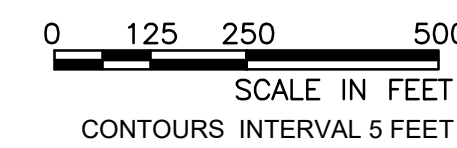

**WOLFDEN**  
Wolfden Mt Chase, LLC  
Rezoning Petition  
Location: T6 R6, Maine

**wood.**  
Environment & Infrastructure Solutions, Inc.  
511 Congress St., Suite 200, Portland, ME 04101  
P: (207) 775-5481 F: (207) 772-4762 www.woodco.com

PROPOSED WATERSHED CONDITIONS  
Project 3617-19-7478  
Figure 2

Prepared/Date: W/JW 08/24/22  
Checked/Date: MAP 08/24/22

C:\Users\william.williams\OneDrive - Wood - F:\C:\Projects\Wolfden - Rezoning\Map\2022\Sheets\Figure 2 - Watershed Proposed Conditions.dwg Wed, 24 Aug 2022 9:40am william.williams



**Attachment 2**

**Precipitation Data - NOAA Atlas 14, Volume 10, Version 3**







**NOAA Atlas 14, Volume 10, Version 3**  
**Location name: Millinocket, Maine, USA\***  
**Latitude: 46.1432°, Longitude: -68.4631°**  
**Elevation: 1177.81 ft\*\***



\* source: ESRI Maps  
 \*\* source: USGS

**POINT PRECIPITATION FREQUENCY ESTIMATES**

Sanja Perica, Sandra Pavlovic, Michael St. Laurent, Carl Trypaluk, Dale Unruh, Orlan Wilhite

NOAA, National Weather Service, Silver Spring, Maryland

[PF\\_tabular](#) | [PF\\_graphical](#) | [Maps & aerials](#)

**PF tabular**

<b>PDS-based point precipitation frequency estimates with 90% confidence intervals (in inches)<sup>1</sup></b>										
<b>Duration</b>	<b>Average recurrence interval (years)</b>									
	<b>1</b>	<b>2</b>	<b>5</b>	<b>10</b>	<b>25</b>	<b>50</b>	<b>100</b>	<b>200</b>	<b>500</b>	<b>1000</b>
<b>5-min</b>	<b>0.225</b> (0.173-0.293)	<b>0.283</b> (0.217-0.369)	<b>0.378</b> (0.289-0.494)	<b>0.458</b> (0.348-0.602)	<b>0.567</b> (0.418-0.779)	<b>0.649</b> (0.470-0.911)	<b>0.735</b> (0.519-1.07)	<b>0.833</b> (0.557-1.24)	<b>0.975</b> (0.630-1.50)	<b>1.09</b> (0.691-1.71)
<b>10-min</b>	<b>0.319</b> (0.244-0.415)	<b>0.401</b> (0.308-0.523)	<b>0.536</b> (0.409-0.700)	<b>0.648</b> (0.492-0.851)	<b>0.803</b> (0.593-1.10)	<b>0.919</b> (0.666-1.29)	<b>1.04</b> (0.736-1.52)	<b>1.18</b> (0.791-1.75)	<b>1.38</b> (0.893-2.12)	<b>1.55</b> (0.980-2.42)
<b>15-min</b>	<b>0.375</b> (0.288-0.488)	<b>0.472</b> (0.362-0.615)	<b>0.631</b> (0.482-0.825)	<b>0.763</b> (0.580-1.00)	<b>0.945</b> (0.697-1.30)	<b>1.08</b> (0.783-1.52)	<b>1.23</b> (0.866-1.79)	<b>1.39</b> (0.931-2.06)	<b>1.63</b> (1.05-2.50)	<b>1.82</b> (1.15-2.85)
<b>30-min</b>	<b>0.521</b> (0.400-0.678)	<b>0.655</b> (0.502-0.854)	<b>0.874</b> (0.668-1.14)	<b>1.06</b> (0.803-1.39)	<b>1.31</b> (0.966-1.80)	<b>1.49</b> (1.09-2.10)	<b>1.69</b> (1.20-2.48)	<b>1.93</b> (1.29-2.86)	<b>2.28</b> (1.47-3.50)	<b>2.57</b> (1.63-4.03)
<b>60-min</b>	<b>0.667</b> (0.512-0.868)	<b>0.838</b> (0.642-1.09)	<b>1.12</b> (0.854-1.46)	<b>1.35</b> (1.03-1.77)	<b>1.67</b> (1.24-2.30)	<b>1.91</b> (1.39-2.69)	<b>2.16</b> (1.54-3.18)	<b>2.47</b> (1.65-3.67)	<b>2.93</b> (1.89-4.50)	<b>3.33</b> (2.11-5.21)
<b>2-hr</b>	<b>0.930</b> (0.719-1.20)	<b>1.15</b> (0.885-1.48)	<b>1.50</b> (1.16-1.94)	<b>1.79</b> (1.37-2.33)	<b>2.20</b> (1.63-2.99)	<b>2.50</b> (1.83-3.47)	<b>2.82</b> (2.01-4.06)	<b>3.19</b> (2.15-4.67)	<b>3.72</b> (2.42-5.64)	<b>4.16</b> (2.65-6.43)
<b>3-hr</b>	<b>1.13</b> (0.875-1.44)	<b>1.37</b> (1.07-1.76)	<b>1.77</b> (1.37-2.28)	<b>2.11</b> (1.62-2.73)	<b>2.57</b> (1.92-3.46)	<b>2.91</b> (2.13-4.01)	<b>3.28</b> (2.33-4.67)	<b>3.68</b> (2.49-5.35)	<b>4.25</b> (2.77-6.40)	<b>4.72</b> (3.01-7.24)
<b>6-hr</b>	<b>1.54</b> (1.21-1.96)	<b>1.85</b> (1.44-2.35)	<b>2.34</b> (1.82-2.98)	<b>2.75</b> (2.13-3.52)	<b>3.31</b> (2.49-4.42)	<b>3.74</b> (2.75-5.08)	<b>4.18</b> (2.99-5.87)	<b>4.66</b> (3.17-6.70)	<b>5.33</b> (3.50-7.92)	<b>5.87</b> (3.76-8.88)
<b>12-hr</b>	<b>2.05</b> (1.62-2.58)	<b>2.41</b> (1.90-3.04)	<b>3.01</b> (2.37-3.80)	<b>3.50</b> (2.74-4.45)	<b>4.18</b> (3.16-5.51)	<b>4.70</b> (3.48-6.31)	<b>5.23</b> (3.76-7.25)	<b>5.80</b> (3.97-8.24)	<b>6.61</b> (4.36-9.69)	<b>7.25</b> (4.66-10.8)
<b>24-hr</b>	<b>2.55</b> (2.03-3.18)	<b>2.97</b> (2.36-3.71)	<b>3.66</b> (2.90-4.58)	<b>4.23</b> (3.34-5.32)	<b>5.02</b> (3.83-6.54)	<b>5.62</b> (4.19-7.46)	<b>6.23</b> (4.51-8.54)	<b>6.90</b> (4.75-9.68)	<b>7.82</b> (5.18-11.3)	<b>8.55</b> (5.53-12.6)
<b>2-day</b>	<b>2.99</b> (2.40-3.69)	<b>3.46</b> (2.77-4.27)	<b>4.22</b> (3.37-5.23)	<b>4.86</b> (3.86-6.05)	<b>5.73</b> (4.40-7.39)	<b>6.40</b> (4.81-8.39)	<b>7.08</b> (5.15-9.56)	<b>7.80</b> (5.41-10.8)	<b>8.79</b> (5.86-12.6)	<b>9.56</b> (6.21-13.9)
<b>3-day</b>	<b>3.29</b> (2.65-4.04)	<b>3.79</b> (3.05-4.65)	<b>4.59</b> (3.69-5.66)	<b>5.26</b> (4.20-6.52)	<b>6.19</b> (4.77-7.92)	<b>6.89</b> (5.19-8.97)	<b>7.61</b> (5.54-10.2)	<b>8.36</b> (5.82-11.5)	<b>9.37</b> (6.27-13.3)	<b>10.2</b> (6.62-14.7)
<b>4-day</b>	<b>3.56</b> (2.88-4.34)	<b>4.07</b> (3.29-4.97)	<b>4.90</b> (3.95-6.01)	<b>5.60</b> (4.48-6.90)	<b>6.55</b> (5.07-8.34)	<b>7.29</b> (5.51-9.43)	<b>8.03</b> (5.86-10.7)	<b>8.79</b> (6.13-12.0)	<b>9.82</b> (6.58-13.8)	<b>10.6</b> (6.93-15.2)
<b>7-day</b>	<b>4.26</b>	<b>4.80</b>	<b>5.69</b>	<b>6.43</b>	<b>7.45</b>	<b>8.24</b>	<b>9.02</b>	<b>9.81</b>	<b>10.9</b>	<b>11.6</b>

	(3.47-5.16)	(3.91-5.83)	(4.62-6.93)	(5.19-7.87)	(5.80-9.39)	(6.26-10.5)	(6.61-11.9)	(6.88-13.3)	(7.31-15.1)	(7.63-16.5)
<b>10-day</b>	<b>4.92</b> (4.03-5.94)	<b>5.50</b> (4.50-6.64)	<b>6.43</b> (5.24-7.79)	<b>7.21</b> (5.84-8.77)	<b>8.28</b> (6.47-10.4)	<b>9.11</b> (6.94-11.6)	<b>9.93</b> (7.29-12.9)	<b>10.7</b> (7.56-14.4)	<b>11.8</b> (7.96-16.3)	<b>12.5</b> (8.24-17.7)
<b>20-day</b>	<b>6.94</b> (5.73-8.29)	<b>7.60</b> (6.27-9.09)	<b>8.68</b> (7.13-10.4)	<b>9.57</b> (7.82-11.5)	<b>10.8</b> (8.49-13.3)	<b>11.8</b> (9.02-14.7)	<b>12.7</b> (9.35-16.3)	<b>13.6</b> (9.61-18.0)	<b>14.6</b> (9.93-19.9)	<b>15.3</b> (10.1-21.3)
<b>30-day</b>	<b>8.62</b> (7.15-10.2)	<b>9.36</b> (7.76-11.1)	<b>10.6</b> (8.73-12.6)	<b>11.6</b> (9.50-13.9)	<b>13.0</b> (10.2-15.9)	<b>14.1</b> (10.8-17.5)	<b>15.1</b> (11.1-19.1)	<b>16.0</b> (11.4-21.1)	<b>17.1</b> (11.7-23.2)	<b>17.8</b> (11.8-24.6)
<b>45-day</b>	<b>10.7</b> (8.93-12.6)	<b>11.6</b> (9.63-13.7)	<b>13.0</b> (10.7-15.3)	<b>14.1</b> (11.6-16.8)	<b>15.7</b> (12.5-19.1)	<b>17.0</b> (13.1-20.9)	<b>18.2</b> (13.5-22.9)	<b>19.2</b> (13.7-25.1)	<b>20.4</b> (14.0-27.4)	<b>21.2</b> (14.1-29.0)
<b>60-day</b>	<b>12.4</b> (10.4-14.6)	<b>13.4</b> (11.2-15.8)	<b>15.0</b> (12.5-17.6)	<b>16.3</b> (13.5-19.3)	<b>18.0</b> (14.4-21.9)	<b>19.5</b> (15.1-23.9)	<b>20.8</b> (15.5-26.0)	<b>21.9</b> (15.7-28.5)	<b>23.3</b> (16.0-31.1)	<b>24.2</b> (16.1-32.9)

<sup>1</sup> Precipitation frequency (PF) estimates in this table are based on frequency analysis of partial duration series (PDS). Numbers in parenthesis are PF estimates at lower and upper bounds of the 90% confidence interval. The probability that precipitation frequency estimates (for a given duration and average recurrence interval) will be greater than the upper bound (or less than the lower bound) is 5%. Estimates at upper bounds are not checked against probable maximum precipitation (PMP) estimates and may be higher than currently valid PMP values. Please refer to NOAA Atlas 14 document for more information.

[Back to Top](#)

### PF graphical

PDS-based depth-duration-frequency (DDF) curves  
Latitude: 46.1432°, Longitude: -68.4631°

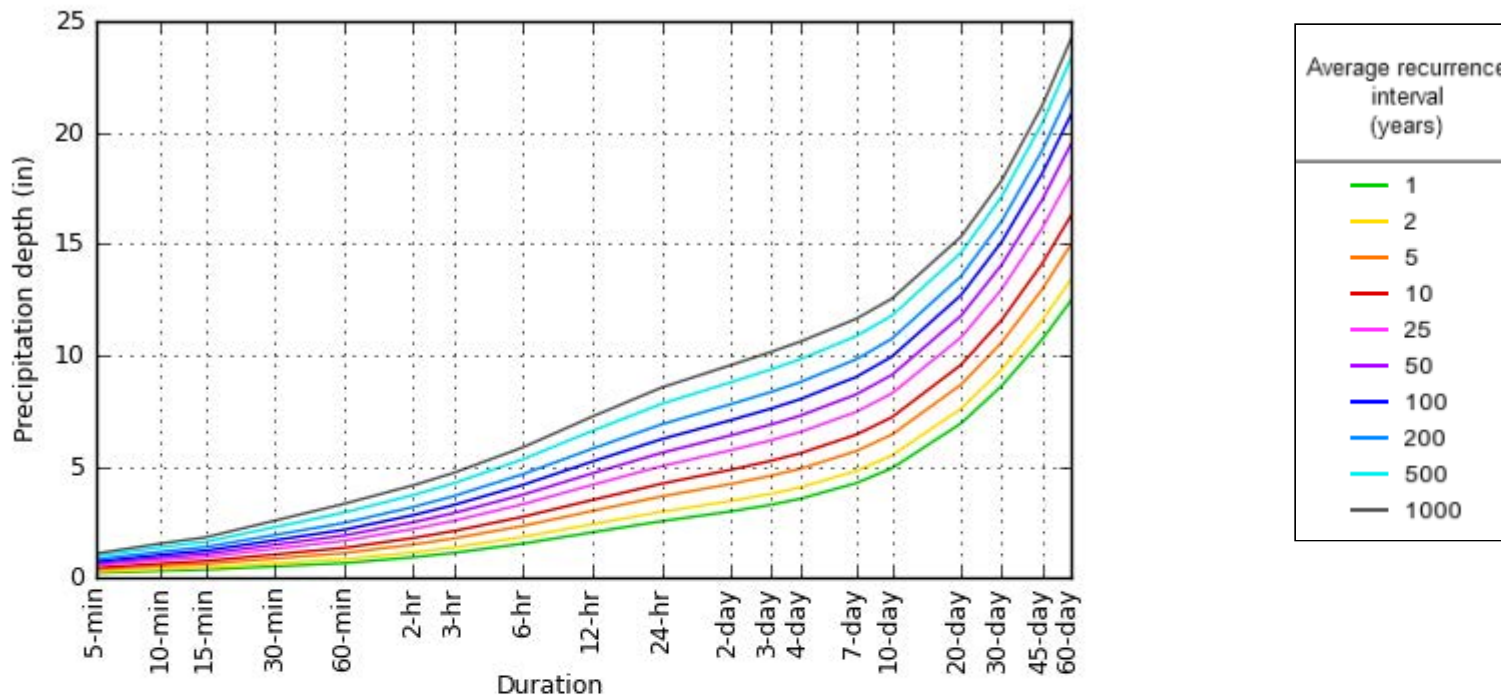

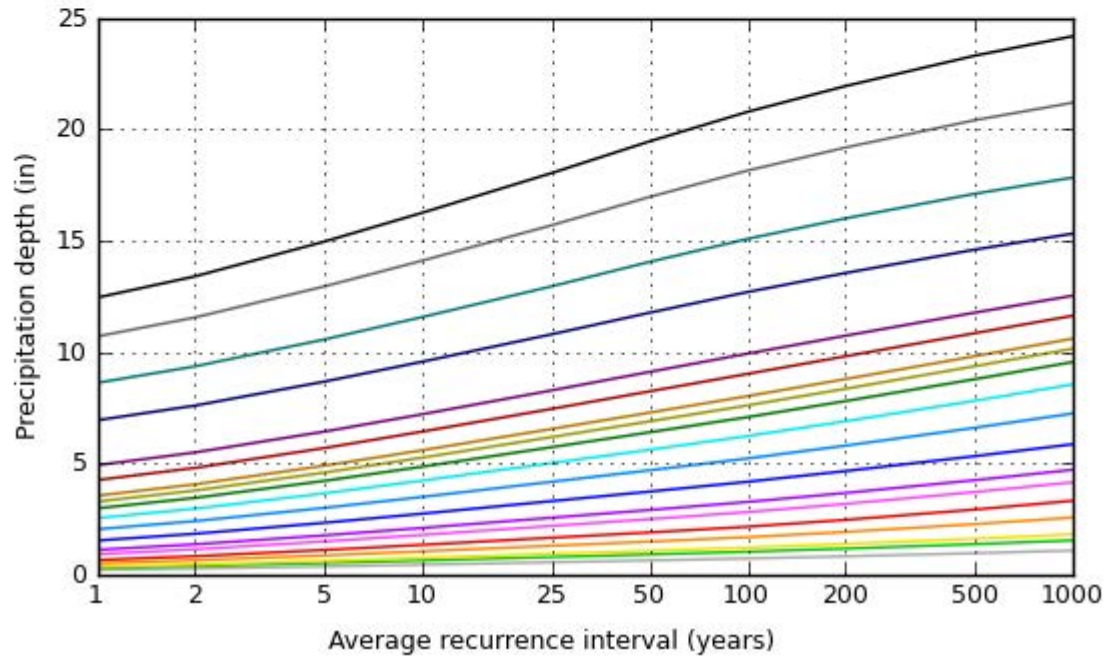

Duration	
5-min	2-day
10-min	3-day
15-min	4-day
30-min	7-day
60-min	10-day
2-hr	20-day
3-hr	30-day
6-hr	45-day
12-hr	60-day
24-hr	

NOAA Atlas 14, Volume 10, Version 3

Created (GMT): Wed May 4 10:57:01 2022

[Back to Top](#)

## Maps & aerials

Small scale terrain

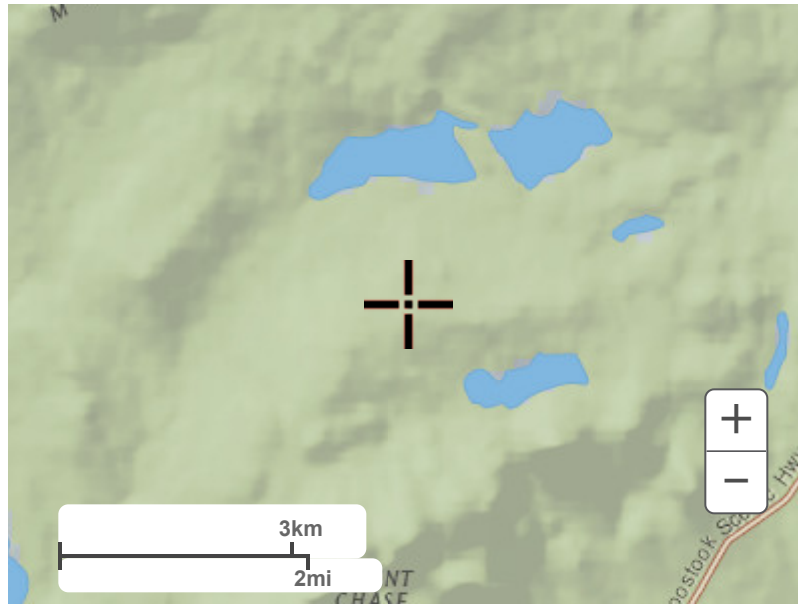

Large scale terrain

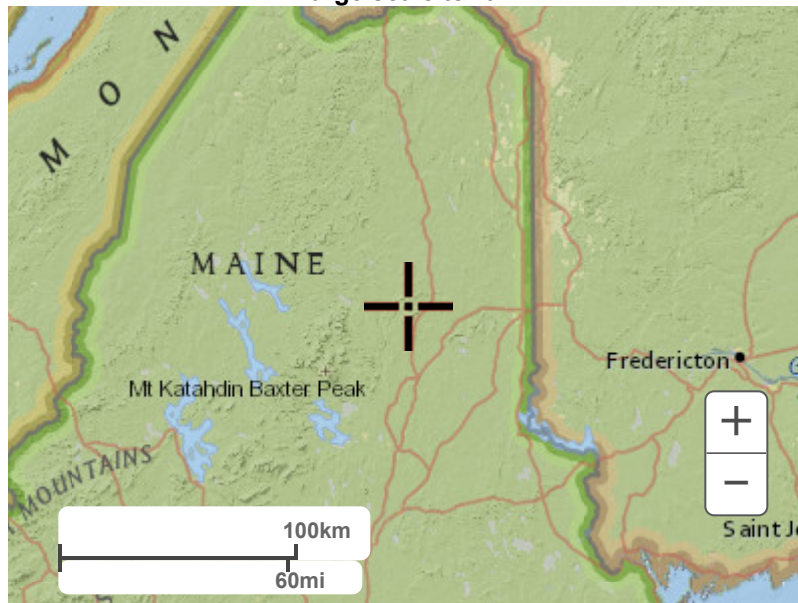

Large scale map



**Attachment 3:**  
**Average Monthly Precipitation Data**



Climate Patten - Maine



	Jan (January)	Feb (February)	Mar (March)	Apr (April)	May (May)	Jun (June)
Av. high	22	26	35	49	62	72
Av. low	2	6	16	29	40	49
Av. precip.	3.28	2.57	3.07	3.85	4.02	3.81



	Jul (July)	Aug (August)	Sep (September)	Oct (October)	Nov (November)	Dec (December)
Av. high	76	75	66	53	40	28
Av. low	55	53	44	34	25	12
Av. precip.	4.08	3.99	4.02	4.27	4.38	3.69

Patten Climate Graph - Maine Climate Chart

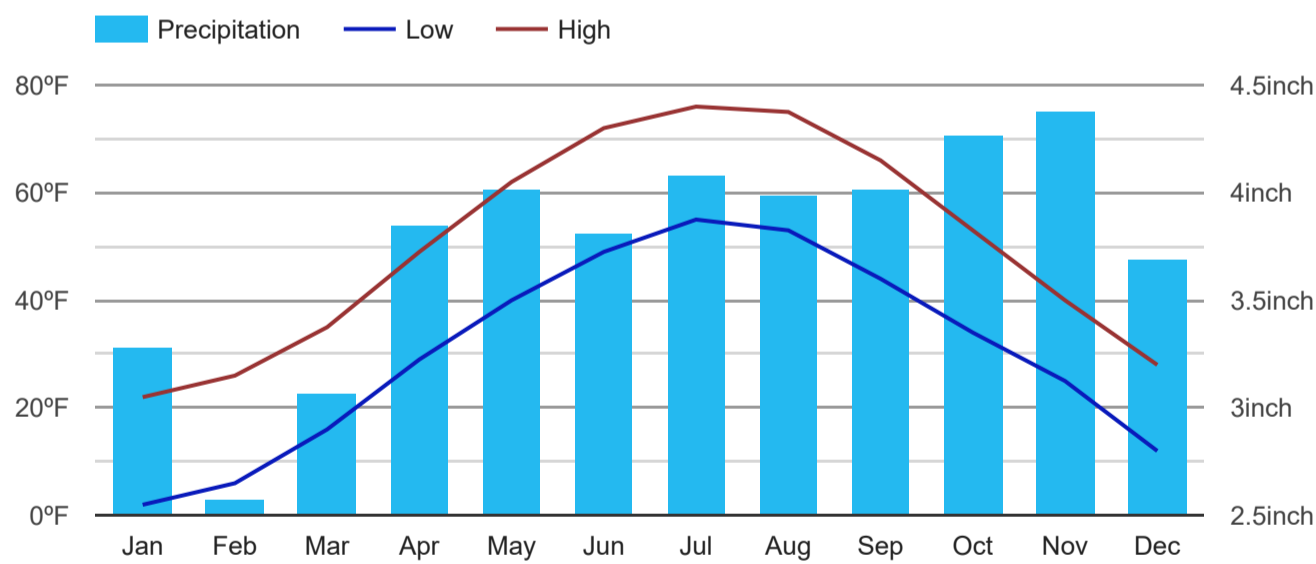

 **Innovate like Google**  
Unlock strategy and resources



Reimagine how you can prepare for retirement.



### Patten weather averages

Annual high temperature	50°F
Annual low temperature	30°F
Average annual precip.	45.03 inch

Share

### Station Data

Monthly averages Patten  
 Longitude: -68.4461, Latitude: 45.9964  
 Average weather Patten, ME - 4765

Monthly: 1981-2010 normals  
 History: 2008-2016

### Abbreviations

Jan (January): January, Feb (February): February, ...

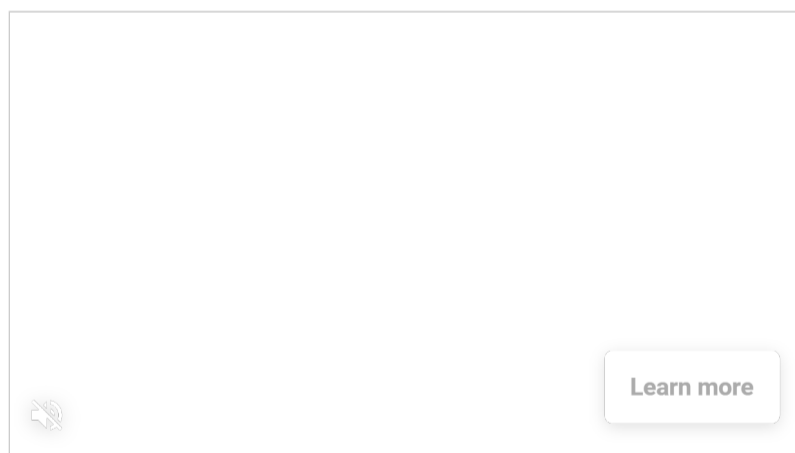

**Reimagine how you can prepare for retirement.**



**Attachment 4:**  
**Seboeis River Gauge Discharge Data**





**Seboeis River Near Shin Pond**

Jan	Feb	Mar	Apr	May	Jun	Jul	Aug	Sept	Oct	Nov	Dec
<b>Average Precipitation in Inches</b>											
3.28	2.57	3.07	3.85	4.02	3.81	4.08	3.99	4.02	4.27	4.38	3.69
<b>Percent Annual Precipitation in Inches</b>											
7.3%	5.7%	6.8%	8.5%	8.9%	8.5%	9.1%	8.9%	8.9%	9.5%	9.7%	8.2%
<b>Mean Daily Discharge in CFS</b>											
190	110	170	990	690	175	85	45	48	105	305	265
<b>Percent Annual Flow</b>											
6.0%	3.5%	5.3%	31.2%	21.7%	5.5%	2.7%	1.4%	1.5%	3.3%	9.6%	8.3%

Blue: Winter Months - frozen conditions with reduced runoff

Grey/Blue: Late Fall-Early Winter or Late Winter- Early Spring - some reduced runoff

Green: Spring months - increased runoff with snow melt

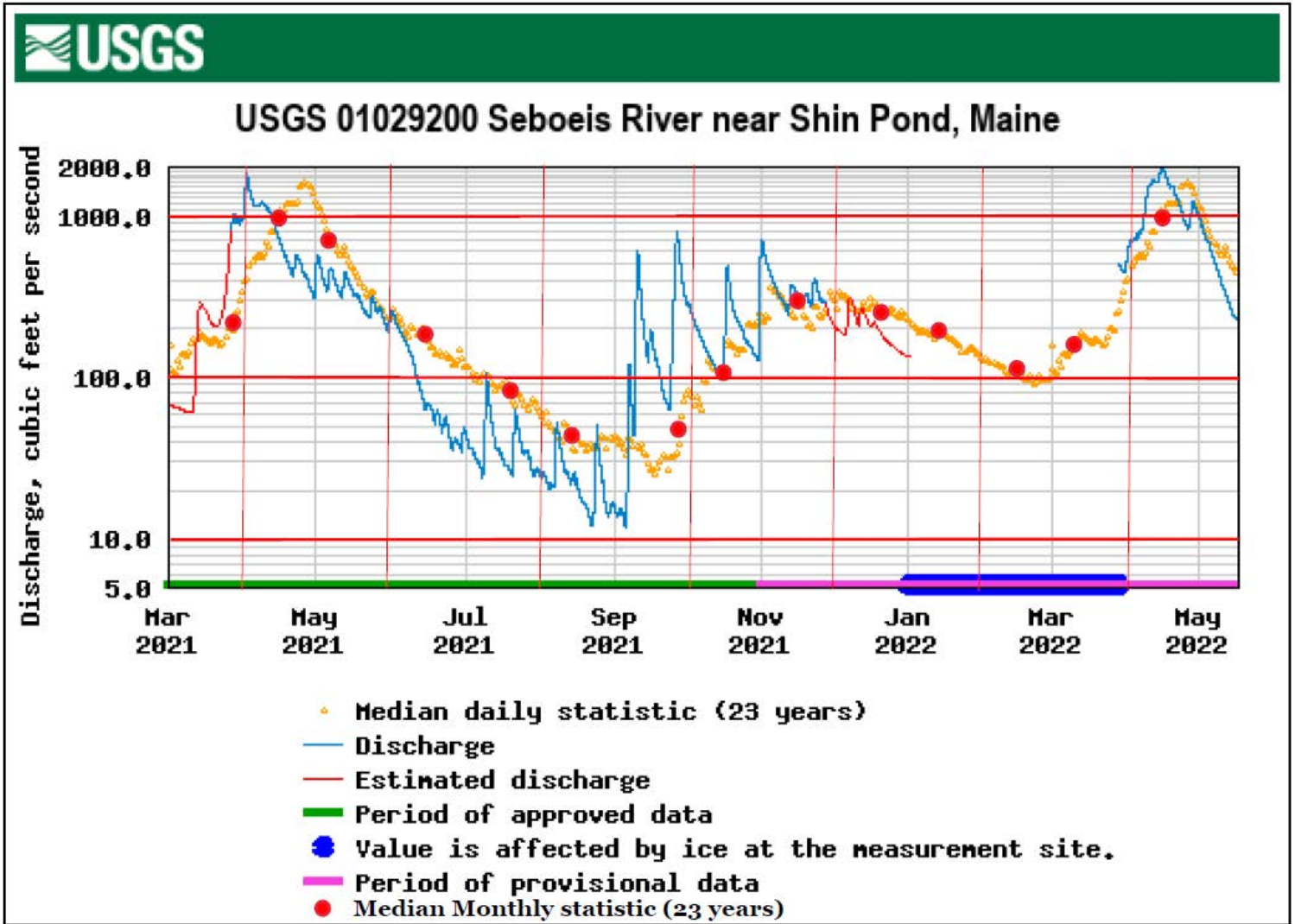

[https://nwis.waterdata.usgs.gov/me/nwis/uv/?ts\\_id=65499&format=img\\_stats&site\\_no=01029200&begin\\_date=20210301](https://nwis.waterdata.usgs.gov/me/nwis/uv/?ts_id=65499&format=img_stats&site_no=01029200&begin_date=20210301)

**Attachment 5:**  
**HydroCAD® Model Output - 500-year, 24-hour Storm Event**



# Wolfden\_Post PreTreatment Pond Sizing

Prepared by Wood

HydroCAD® 10.10-5a s/n 00629 © 2020 HydroCAD Software Solutions LLC

---

## TABLE OF CONTENTS

### **Project Reports**

- 1 Routing Diagram
- 2 Area Listing (all nodes)
- 3 Soil Listing (all nodes)
- 4 Pipe Listing (all nodes)

### **Current Event**

- 5 Subcat DA-13A: Developed Mine Area - Phase II
- 7 Subcat DA-6A: Pre-Treatment Pond
- 9 Subcat DA-7A: Developed Mine Area
- 12 Pond P-1: PreTreatment Pond

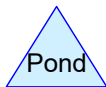
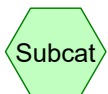
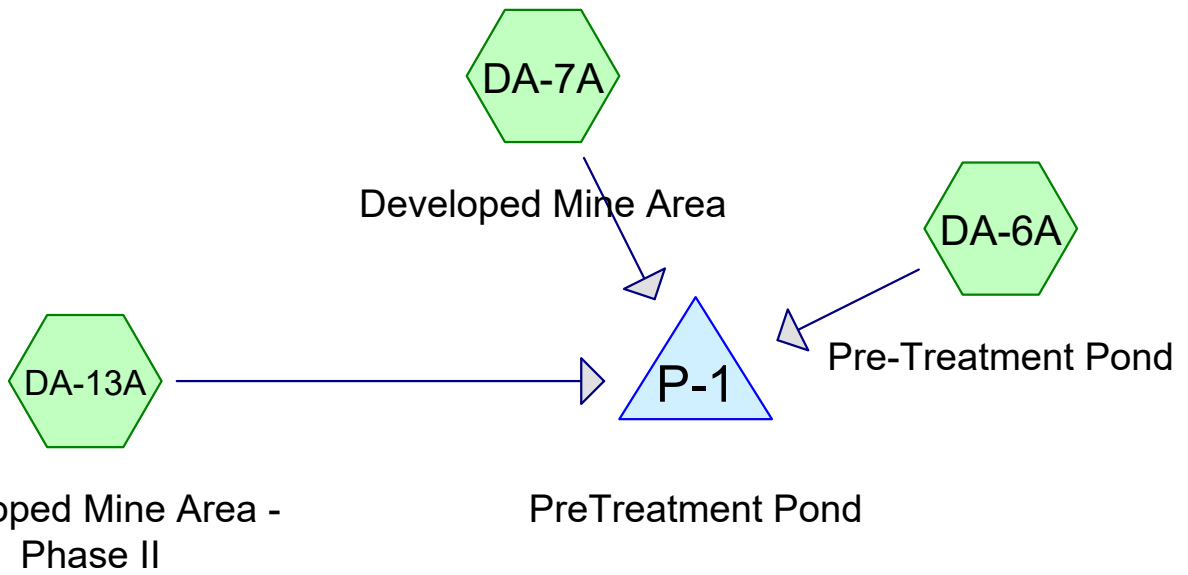



**Woldfen\_Post PreTreatment Pond Sizing**

Prepared by Wood

Printed 5/9/2022

HydroCAD® 10.10-5a s/n 00629 © 2020 HydroCAD Software Solutions LLC

Page 2

**Area Listing (all nodes)**

Area (acres)	CN	Description (subcatchment-numbers)
6.761	86	Area Surrounding Mine Facilities, HSG C (DA-13A, DA-7A)
0.334	96	Backfill Plant, HSG C (DA-7A)
0.023	98	Blast Shack, HSG C (DA-7A)
0.099	98	Core Shack & Storage, HSG C (DA-7A)
0.042	98	Equipment Fueling Station, HSG C (DA-7A)
0.071	98	Headframe & Hoist, HSG C (DA-13A)
5.276	96	Low Grade Ore Storage Pad, HSG C (DA-7A)
0.110	98	Maintenance Shop, HSG C (DA-7A)
0.385	98	Mine Access (Portal), HSG C (DA-7A)
0.214	98	Office & Mine Rescue, HSG C (DA-7A)
1.259	96	Ore (Mill Feed) Storage Pad #1, HSG C (DA-7A)
1.016	96	Ore (Mill Feed) Storage Pad #2, HSG C (DA-13A)
2.818	98	Pre-Treatment Water Storage Pond, HSG C (DA-6A)
2.368	96	Site Mine Roads, HSG C (DA-7A)
2.579	96	Snow Storage, HSG C (DA-7A)
0.427	86	Surrounding berm, HSG C (DA-6A)
1.016	96	Waste Rock Pad #2, HSG C (DA-13A)
3.591	96	Waste Rock Storage Pad #1, HSG C (DA-7A)
<b>28.389</b>	<b>94</b>	<b>TOTAL AREA</b>

**Wolfden\_Post PreTreatment Pond Sizing**

Prepared by Wood

Printed 5/9/2022

HydroCAD® 10.10-5a s/n 00629 © 2020 HydroCAD Software Solutions LLC

Page 3

**Soil Listing (all nodes)**

Area (acres)	Soil Group	Subcatchment Numbers
0.000	HSG A	
0.000	HSG B	
28.389	HSG C	DA-13A, DA-6A, DA-7A
0.000	HSG D	
0.000	Other	
<b>28.389</b>		<b>TOTAL AREA</b>

**Woldfen\_Post PreTreatment Pond Sizing**

Prepared by Wood

Printed 5/9/2022

HydroCAD® 10.10-5a s/n 00629 © 2020 HydroCAD Software Solutions LLC

Page 4

**Pipe Listing (all nodes)**

Line#	Node Number	In-Invert (feet)	Out-Invert (feet)	Length (feet)	Slope (ft/ft)	n	Width (inches)	Diam/Height (inches)	Inside-Fill (inches)
1	DA-7A	0.00	0.00	1,320.0	0.0100	0.013	0.0	24.0	0.0

# Wolfden\_Post PreTreatment Pond Sizing

Prepared by Wood

Printed 5/9/2022

HydroCAD® 10.10-5a s/n 00629 © 2020 HydroCAD Software Solutions LLC

Page 5

## Summary for Subcatchment DA-13A: Developed Mine Area - Phase II

Runoff = 20.99 cfs @ 12.10 hrs, Volume= 1.626 af, Depth> 6.57"

Runoff by SCS TR-20 method, UH=SCS, Weighted-CN, Time Span= 5.00-20.00 hrs, dt= 0.05 hrs  
Type III 24-hr 500-Year Rainfall=7.82"

Area (ac)	CN	Description
* 1.016	96	Ore (Mill Feed) Storage Pad #2, HSG C
* 1.016	96	Waste Rock Pad #2, HSG C
* 0.071	98	Headframe & Hoist, HSG C
* 0.868	86	Area Surrounding Mine Facilities, HSG C
2.971	93	Weighted Average
2.900		97.61% Pervious Area
0.071		2.39% Impervious Area

Tc (min)	Length (feet)	Slope (ft/ft)	Velocity (ft/sec)	Capacity (cfs)	Description
5.8	150	0.0200	0.43		<b>Sheet Flow,</b> Fallow n= 0.050 P2= 2.97"
1.5	200	0.0200	2.28		<b>Shallow Concentrated Flow,</b> Unpaved Kv= 16.1 fps
7.3	350	Total			

## Subcatchment DA-13A: Developed Mine Area - Phase II

Hydrograph

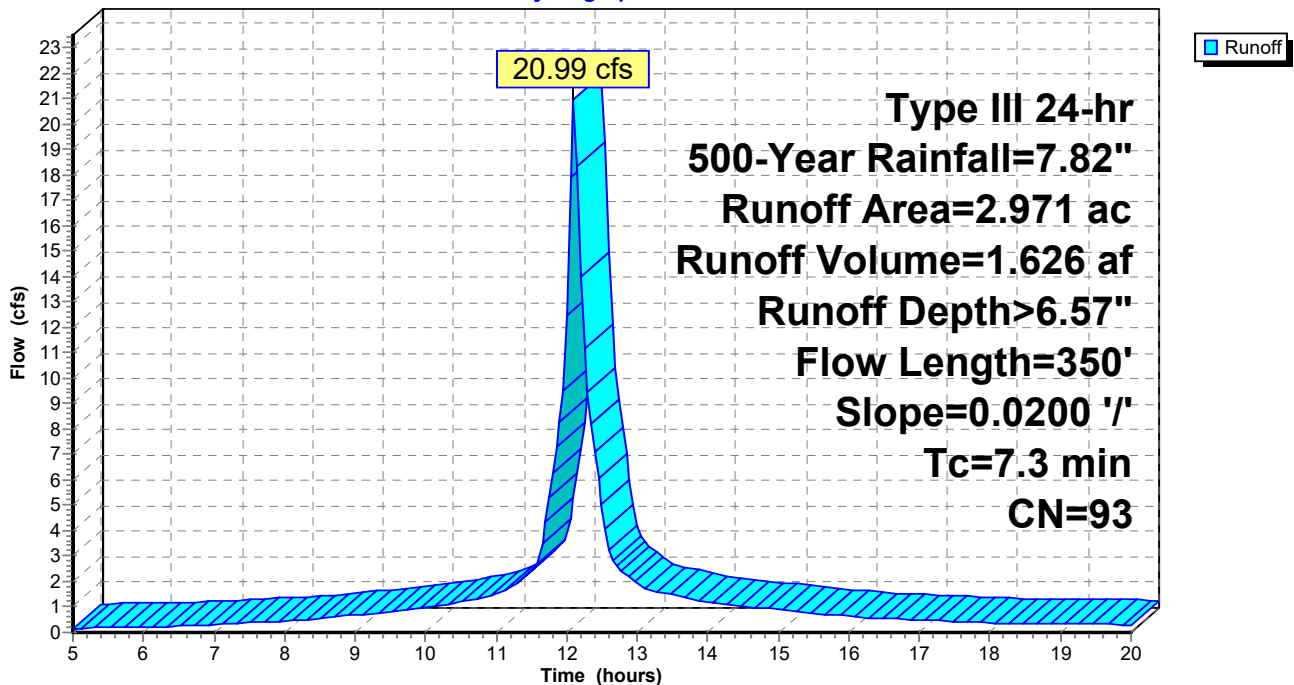



# Woldfen\_Post PreTreatment Pond Sizing

Prepared by Wood

HydroCAD® 10.10-5a s/n 00629 © 2020 HydroCAD Software Solutions LLC

Woldfen MT Chase - Picket Mtn Mine Project

Type III 24-hr 500-Year Rainfall=7.82"

Printed 5/9/2022

Page 6

## Hydrograph for Subcatchment DA-13A: Developed Mine Area - Phase II

Time (hours)	Precip. (inches)	Excess (inches)	Runoff (cfs)	Time (hours)	Precip. (inches)	Excess (inches)	Runoff (cfs)
5.00	0.44	0.08	0.16	18.00	7.26	6.43	0.38
5.25	0.47	0.10	0.17	18.25	7.29	6.46	0.37
5.50	0.50	0.11	0.19	18.50	7.32	6.49	0.36
5.75	0.53	0.13	0.20	18.75	7.35	6.52	0.35
6.00	0.56	0.15	0.21	19.00	7.38	6.54	0.34
6.25	0.60	0.17	0.23	19.25	7.40	6.57	0.33
6.50	0.63	0.19	0.26	19.50	7.43	6.60	0.32
6.75	0.67	0.21	0.29	19.75	7.46	6.63	0.31
7.00	0.71	0.24	0.32	20.00	<b>7.48</b>	<b>6.65</b>	0.31
7.25	0.75	0.27	0.35				
7.50	0.79	0.30	0.38				
7.75	0.84	0.33	0.41				
8.00	0.89	0.37	0.44				
8.25	0.95	0.41	0.49				
8.50	1.00	0.45	0.55				
8.75	1.07	0.50	0.62				
9.00	1.14	0.56	0.68				
9.25	1.22	0.62	0.75				
9.50	1.30	0.69	0.82				
9.75	1.38	0.77	0.89				
10.00	1.48	0.85	0.97				
10.25	1.58	0.94	1.07				
10.50	1.69	1.04	1.21				
10.75	1.82	1.15	1.35				
11.00	1.96	1.27	1.50				
11.25	2.12	1.43	1.84				
11.50	2.33	1.62	2.37				
11.75	2.78	2.04	5.31				
12.00	3.91	3.13	<b>12.49</b>				
12.25	5.04	4.24	<b>11.15</b>				
12.50	5.49	4.68	5.03				
12.75	5.70	4.89	2.48				
13.00	5.86	5.05	1.93				
13.25	6.00	5.18	1.61				
13.50	6.13	5.31	1.47				
13.75	6.24	5.42	1.34				
14.00	6.34	5.52	1.20				
14.25	6.44	5.61	1.10				
14.50	6.52	5.70	1.03				
14.75	6.60	5.78	0.97				
15.00	6.68	5.85	0.90				
15.25	6.75	5.92	0.83				
15.50	6.82	5.99	0.77				
15.75	6.87	6.05	0.70				
16.00	6.93	6.10	0.63				
16.25	6.98	6.15	0.59				
16.50	7.03	6.20	0.56				
16.75	7.07	6.24	0.53				
17.00	7.11	6.28	0.50				
17.25	7.15	6.32	0.47				
17.50	7.19	6.36	0.44				
17.75	7.22	6.39	0.41				

### Wolfden\_Post PreTreatment Pond Sizing

Prepared by Wood

Printed 5/9/2022

HydroCAD® 10.10-5a s/n 00629 © 2020 HydroCAD Software Solutions LLC

Page 7

### Summary for Subcatchment DA-6A: Pre-Treatment Pond

Runoff = 24.20 cfs @ 12.09 hrs, Volume= 1.850 af, Depth> 6.84"

Runoff by SCS TR-20 method, UH=SCS, Weighted-CN, Time Span= 5.00-20.00 hrs, dt= 0.05 hrs  
Type III 24-hr 500-Year Rainfall=7.82"

Area (ac)	CN	Description
* 2.818	98	Pre-Treatment Water Storage Pond, HSG C
* 0.427	86	Surrounding berm, HSG C
3.245	96	Weighted Average
0.427		13.16% Pervious Area
2.818		86.84% Impervious Area

Tc (min)	Length (feet)	Slope (ft/ft)	Velocity (ft/sec)	Capacity (cfs)	Description
5.0					<b>Direct Entry,</b>
0.9	550		9.83		<b>Lake or Reservoir,</b>
					Mean Depth= 3.00'
5.9	550	Total			

### Subcatchment DA-6A: Pre-Treatment Pond

Hydrograph

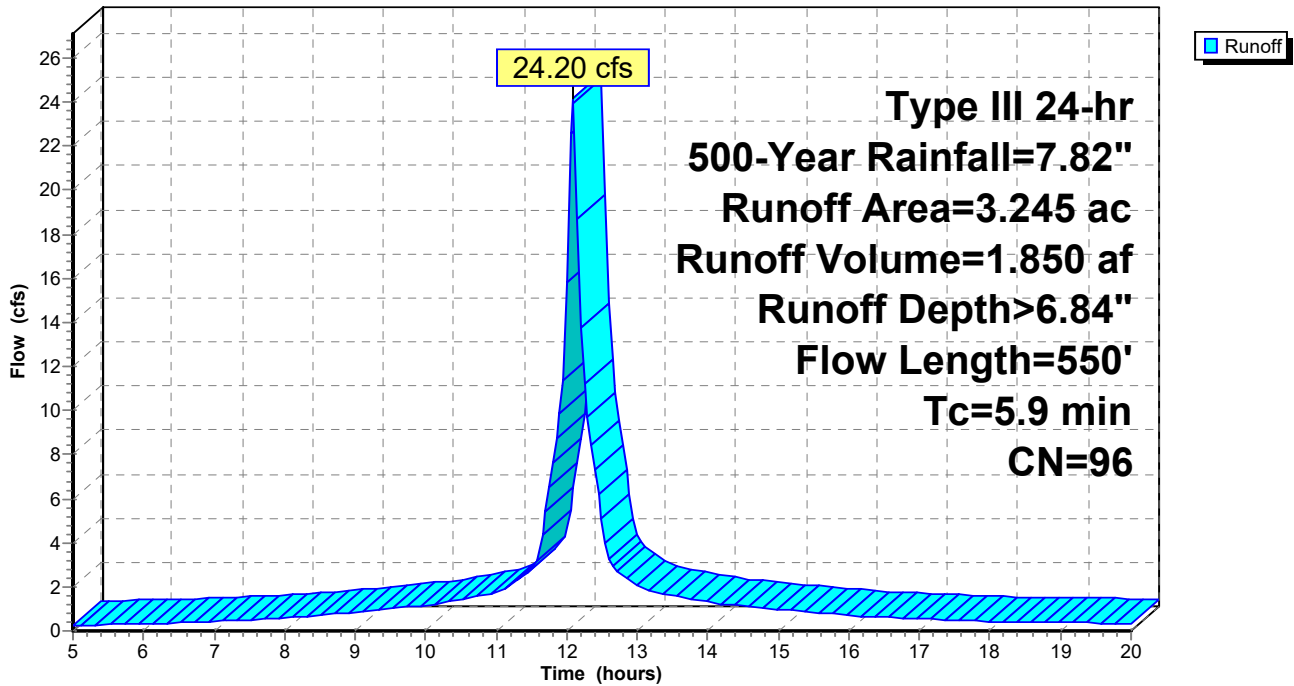

**Wolfden\_Post PreTreatment Pond Sizing**

Prepared by Wood

Printed 5/9/2022

HydroCAD® 10.10-5a s/n 00629 © 2020 HydroCAD Software Solutions LLC

Page 8

**Hydrograph for Subcatchment DA-6A: Pre-Treatment Pond**

Time (hours)	Precip. (inches)	Excess (inches)	Runoff (cfs)	Time (hours)	Precip. (inches)	Excess (inches)	Runoff (cfs)
5.00	0.44	0.17	0.26	18.00	7.26	6.78	0.42
5.25	0.47	0.19	0.27	18.25	7.29	6.81	0.40
5.50	0.50	0.21	0.29	18.50	7.32	6.84	0.39
5.75	0.53	0.23	0.30	18.75	7.35	6.87	0.38
6.00	0.56	0.26	0.32	19.00	7.38	6.90	0.37
6.25	0.60	0.28	0.34	19.25	7.40	6.93	0.36
6.50	0.63	0.31	0.37	19.50	7.43	6.95	0.35
6.75	0.67	0.34	0.41	19.75	7.46	6.98	0.34
7.00	0.71	0.37	0.44	20.00	<b>7.48</b>	<b>7.01</b>	0.34
7.25	0.75	0.41	0.47				
7.50	0.79	0.45	0.51				
7.75	0.84	0.49	0.54				
8.00	0.89	0.53	0.58				
8.25	0.95	0.58	0.63				
8.50	1.00	0.63	0.71				
8.75	1.07	0.69	0.78				
9.00	1.14	0.76	0.86				
9.25	1.22	0.83	0.93				
9.50	1.30	0.90	1.01				
9.75	1.38	0.99	1.08				
10.00	1.48	1.07	1.16				
10.25	1.58	1.17	1.28				
10.50	1.69	1.28	1.44				
10.75	1.82	1.40	1.59				
11.00	1.96	1.53	1.75				
11.25	2.12	1.69	2.17				
11.50	2.33	1.90	2.76				
11.75	2.78	2.33	6.49				
12.00	3.91	3.45	<b>15.84</b>				
12.25	5.04	4.57	<b>11.22</b>				
12.50	5.49	5.02	5.07				
12.75	5.70	5.23	2.66				
13.00	5.86	5.39	2.07				
13.25	6.00	5.53	1.76				
13.50	6.13	5.65	1.61				
13.75	6.24	5.77	1.46				
14.00	6.34	5.87	1.30				
14.25	6.44	5.96	1.20				
14.50	6.52	6.05	1.13				
14.75	6.60	6.13	1.06				
15.00	6.68	6.20	0.98				
15.25	6.75	6.28	0.91				
15.50	6.82	6.34	0.84				
15.75	6.87	6.40	0.76				
16.00	6.93	6.45	0.69				
16.25	6.98	6.50	0.64				
16.50	7.03	6.55	0.61				
16.75	7.07	6.59	0.58				
17.00	7.11	6.64	0.55				
17.25	7.15	6.68	0.52				
17.50	7.19	6.71	0.48				
17.75	7.22	6.75	0.45				

**Wolfden\_Post PreTreatment Pond Sizing**

Prepared by Wood

Printed 5/9/2022

HydroCAD® 10.10-5a s/n 00629 © 2020 HydroCAD Software Solutions LLC

Page 9

**Summary for Subcatchment DA-7A: Developed Mine Area**

Runoff = 145.20 cfs @ 12.13 hrs, Volume= 12.131 af, Depth> 6.57"

Runoff by SCS TR-20 method, UH=SCS, Weighted-CN, Time Span= 5.00-20.00 hrs, dt= 0.05 hrs  
Type III 24-hr 500-Year Rainfall=7.82"

Area (ac)	CN	Description
* 5.276	96	Low Grade Ore Storage Pad, HSG C
* 2.579	96	Snow Storage, HSG C
* 0.214	98	Office & Mine Rescue, HSG C
* 0.099	98	Core Shack & Storage, HSG C
* 0.110	98	Maintenance Shop, HSG C
* 0.042	98	Equipment Fueling Station, HSG C
* 3.591	96	Waste Rock Storage Pad #1, HSG C
* 0.334	96	Backfill Plant, HSG C
* 1.259	96	Ore (Mill Feed) Storage Pad #1, HSG C
* 0.023	98	Blast Shack, HSG C
* 0.385	98	Mine Access (Portal), HSG C
* 2.368	96	Site Mine Roads, HSG C
* 5.893	86	Area Surrounding Mine Facilities, HSG C
22.173	93	Weighted Average
21.300		96.06% Pervious Area
0.873		3.94% Impervious Area

Tc (min)	Length (feet)	Slope (ft/ft)	Velocity (ft/sec)	Capacity (cfs)	Description
4.7	100	0.0150	0.35		<b>Sheet Flow,</b> Fallow n= 0.050 P2= 2.97"
1.7	200	0.0150	1.97		<b>Shallow Concentrated Flow,</b> Unpaved Kv= 16.1 fps
3.1	1,320	0.0100	7.20	22.62	<b>Pipe Channel,</b> 24.0" Round Area= 3.1 sf Perim= 6.3' r= 0.50' n= 0.013
9.5	1,620	Total			



# Woldfen\_Post PreTreatment Pond Sizing

Prepared by Wood

HydroCAD® 10.10-5a s/n 00629 © 2020 HydroCAD Software Solutions LLC

Woldfen MT Chase - Picket Mtn Mine Project

Type III 24-hr 500-Year Rainfall=7.82"

Printed 5/9/2022

Page 10

## Subcatchment DA-7A: Developed Mine Area

Hydrograph

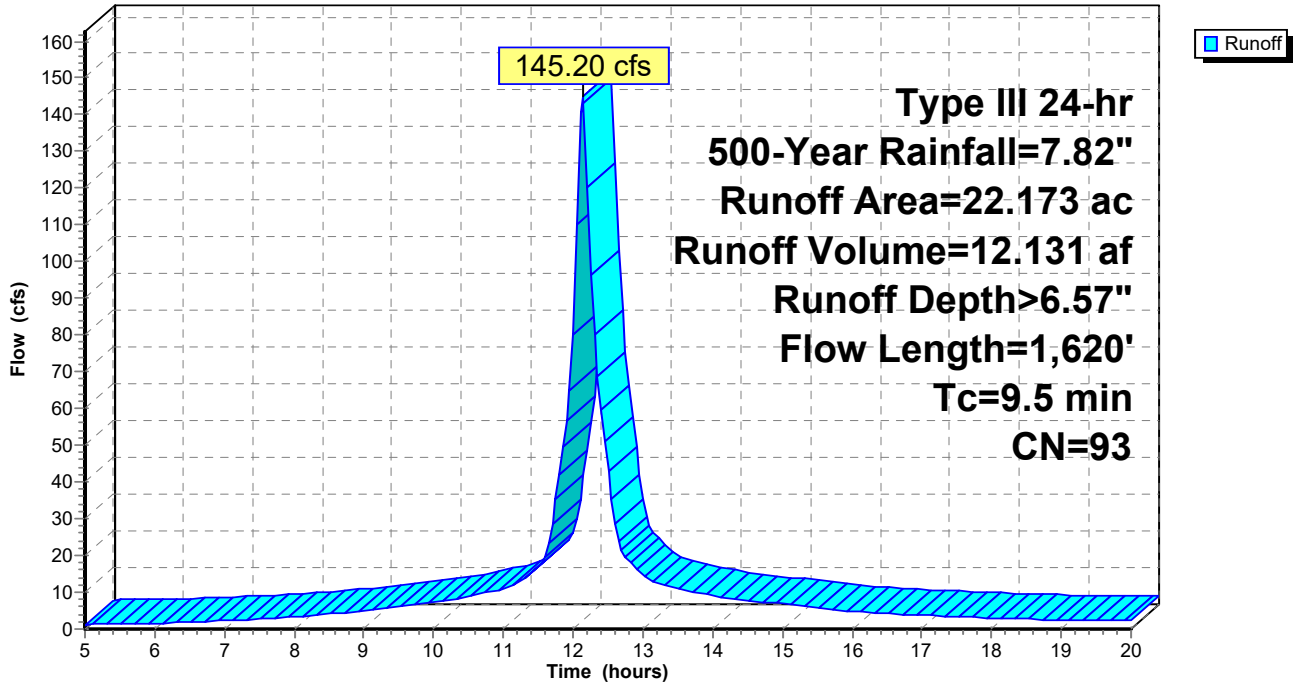

**Wolfden\_Post PreTreatment Pond Sizing**

Prepared by Wood

Printed 5/9/2022

HydroCAD® 10.10-5a s/n 00629 © 2020 HydroCAD Software Solutions LLC

Page 11

**Hydrograph for Subcatchment DA-7A: Developed Mine Area**

Time (hours)	Precip. (inches)	Excess (inches)	Runoff (cfs)	Time (hours)	Precip. (inches)	Excess (inches)	Runoff (cfs)
5.00	0.44	0.08	1.16	18.00	7.26	6.43	2.90
5.25	0.47	0.10	1.26	18.25	7.29	6.46	2.75
5.50	0.50	0.11	1.37	18.50	7.32	6.49	2.68
5.75	0.53	0.13	1.47	18.75	7.35	6.52	2.62
6.00	0.56	0.15	1.57	19.00	7.38	6.54	2.55
6.25	0.60	0.17	1.71	19.25	7.40	6.57	2.49
6.50	0.63	0.19	1.91	19.50	7.43	6.60	2.42
6.75	0.67	0.21	2.12	19.75	7.46	6.63	2.36
7.00	0.71	0.24	2.33	20.00	<b>7.48</b>	<b>6.65</b>	2.29
7.25	0.75	0.27	2.55				
7.50	0.79	0.30	2.78				
7.75	0.84	0.33	3.01				
8.00	0.89	0.37	3.25				
8.25	0.95	0.41	3.59				
8.50	1.00	0.45	4.05				
8.75	1.07	0.50	4.54				
9.00	1.14	0.56	5.03				
9.25	1.22	0.62	5.54				
9.50	1.30	0.69	6.06				
9.75	1.38	0.77	6.59				
10.00	1.48	0.85	7.13				
10.25	1.58	0.94	7.88				
10.50	1.69	1.04	8.90				
10.75	1.82	1.15	9.96				
11.00	1.96	1.27	11.02				
11.25	2.12	1.43	13.29				
11.50	2.33	1.62	17.12				
11.75	2.78	2.04	35.20				
12.00	3.91	3.13	<b>80.14</b>				
12.25	5.04	4.24	<b>96.54</b>				
12.50	5.49	4.68	43.00				
12.75	5.70	4.89	19.57				
13.00	5.86	5.05	14.91				
13.25	6.00	5.18	12.23				
13.50	6.13	5.31	11.14				
13.75	6.24	5.42	10.11				
14.00	6.34	5.52	9.07				
14.25	6.44	5.61	8.27				
14.50	6.52	5.70	7.77				
14.75	6.60	5.78	7.27				
15.00	6.68	5.85	6.78				
15.25	6.75	5.92	6.28				
15.50	6.82	5.99	5.79				
15.75	6.87	6.05	5.29				
16.00	6.93	6.10	4.79				
16.25	6.98	6.15	4.42				
16.50	7.03	6.20	4.20				
16.75	7.07	6.24	3.98				
17.00	7.11	6.28	3.76				
17.25	7.15	6.32	3.55				
17.50	7.19	6.36	3.33				
17.75	7.22	6.39	3.12				

**Wolfden\_Post PreTreatment Pond Sizing**

Prepared by Wood

Printed 5/9/2022

HydroCAD® 10.10-5a s/n 00629 © 2020 HydroCAD Software Solutions LLC

Page 12

**Summary for Pond P-1: PreTreatment Pond**

Base Flow 30 GPM mine dewatering flow

Inflow Area = 28.389 ac, 13.25% Impervious, Inflow Depth > 6.63" for 500-Year event  
 Inflow = 188.44 cfs @ 12.12 hrs, Volume= 15.693 af, Incl. 0.07 cfs Base Flow  
 Outflow = 0.00 cfs @ 8.85 hrs, Volume= 0.001 af, Atten= 100%, Lag= 0.0 min  
 Primary = 0.00 cfs @ 8.85 hrs, Volume= 0.001 af

Routing by Stor-Ind method, Time Span= 5.00-20.00 hrs, dt= 0.05 hrs / 2  
 Peak Elev= 1,184.76' @ 20.00 hrs Surf.Area= 111,887 sf Storage= 683,213 cf ← **Peak Storage**  
 Flood Elev= 1,186.50' Surf.Area= 117,672 sf Storage= 882,501 cf

Plug-Flow detention time= (not calculated: initial storage exceeds outflow)  
 Center-of-Mass det. time= 72.9 min ( 817.9 - 745.0 )

Volume	Invert	Avail.Storage	Storage Description
#1	1,178.00'	1,062,806 cf	<b>Pre-Treatment Water Storage Pond (Prismatic)</b> Listed below (Recalc)

Elevation (feet)	Surf.Area (sq-ft)	Inc.Store (cubic-feet)	Cum.Store (cubic-feet)
1,178.00	90,440	0	0
1,180.00	96,585	187,025	187,025
1,182.00	102,890	199,475	386,500
1,184.00	109,356	212,246	598,746
1,186.00	115,985	225,341	824,087
1,188.00	122,734	238,719	1,062,806

Device	Routing	Invert	Outlet Devices
#1	Primary	1,178.00'	<b>Treatment Rate</b>
			Head (feet) 0.00 0.50 10.00
			Disch. (cfs) 0.000 ← <b>No Pond Discharge Assumed</b>

**Primary OutFlow** Max=0.00 cfs @ 8.85 hrs HW=1,178.50' (Free Discharge)  
 ← **Treatment Rate** (Custom Controls 0.00 cfs)

# Woldfen\_Post PreTreatment Pond Sizing

Prepared by Wood

HydroCAD® 10.10-5a s/n 00629 © 2020 HydroCAD Software Solutions LLC

Woldfen MT Chase - Picket Mtn Mine Project

Type III 24-hr 500-Year Rainfall=7.82"

Printed 5/9/2022

Page 13

## Pond P-1: PreTreatment Pond

Hydrograph

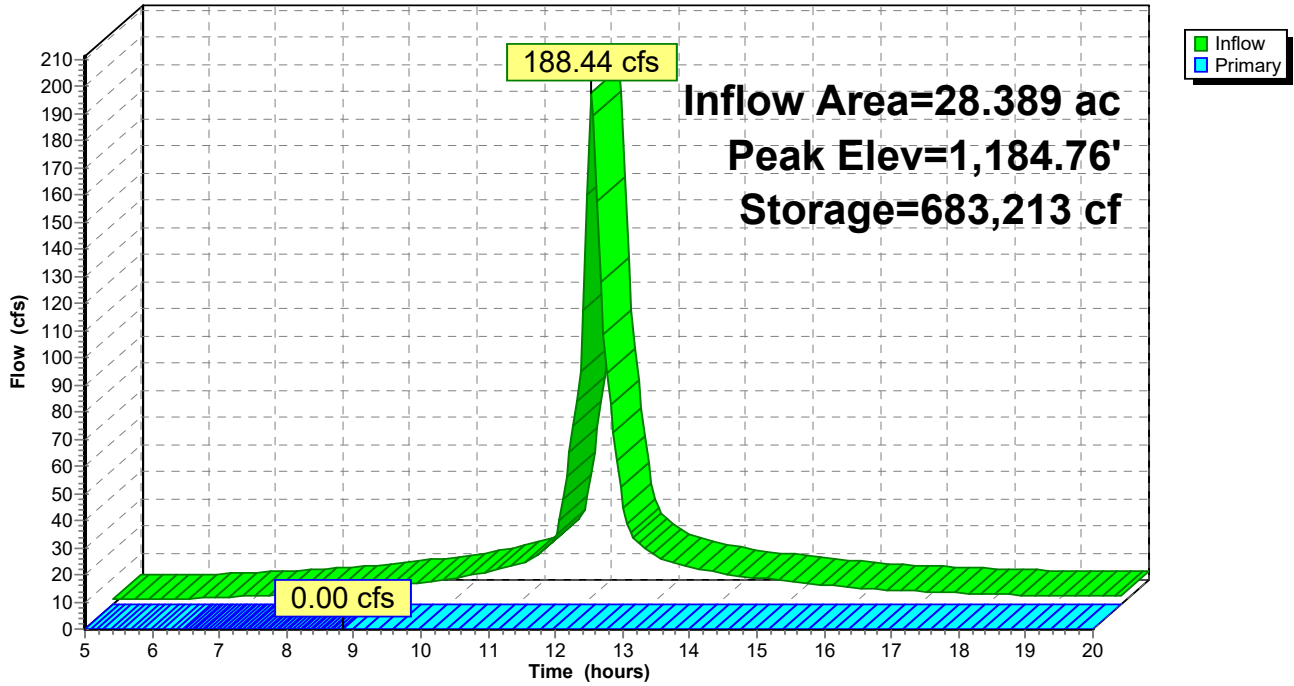



**Wolfden\_Post PreTreatment Pond Sizing**

Prepared by Wood

Printed 5/9/2022

HydroCAD® 10.10-5a s/n 00629 © 2020 HydroCAD Software Solutions LLC

Page 14

**Hydrograph for Pond P-1: PreTreatment Pond**

Time (hours)	Inflow (cfs)	Storage (cubic-feet)	Elevation (feet)	Primary (cfs)
5.00	1.65	74	1,178.00	0.00
5.50	1.91	3,277	1,178.04	0.00
6.00	2.17	6,949	1,178.08	0.00
6.50	2.61	11,207	1,178.12	0.00
7.00	3.16	16,390	1,178.18	0.00
7.50	3.73	22,585	1,178.25	0.00
8.00	4.34	29,842	1,178.33	0.00
8.50	5.38	38,485	1,178.42	<b>0.00</b>
9.00	6.64	49,293	1,178.54	<b>0.00</b>
9.50	7.96	62,431	1,178.68	0.00
10.00	9.32	77,984	1,178.85	0.00
10.50	11.62	96,625	1,179.05	0.00
11.00	14.34	119,979	1,179.30	0.00
11.50	22.31	151,794	1,179.63	0.00
12.00	<b>108.55</b>	244,415	1,180.59	0.00
12.50	<b>53.17</b>	458,076	1,182.69	0.00
13.00	18.98	508,938	1,183.17	0.00
13.50	14.29	537,685	1,183.44	0.00
14.00	11.64	561,027	1,183.65	0.00
14.50	10.00	580,284	1,183.83	0.00
15.00	8.73	597,138	1,183.99	0.00
15.50	7.46	611,706	1,184.12	0.00
16.00	6.18	623,983	1,184.23	0.00
16.50	5.44	634,324	1,184.32	0.00
17.00	4.88	643,606	1,184.41	0.00
17.50	4.33	651,892	1,184.48	0.00
18.00	3.77	659,181	1,184.55	0.00
18.50	3.50	665,663	1,184.61	0.00
19.00	3.33	671,814	1,184.66	0.00
19.50	3.17	677,665	1,184.71	0.00
20.00	3.00	<b>683,217</b>	<b>1,184.76</b>	0.00

← Peak water storage and elevation

# Woldfen\_Post PreTreatment Pond Sizing

Prepared by Wood

HydroCAD® 10.10-5a s/n 00629 © 2020 HydroCAD Software Solutions LLC

Type III 24-hr 500-Year Rainfall=7.82"

Printed 5/11/2022

## Stage-Area-Storage for Pond P-1: PreTreatment Pond

Elevation (feet)	Surface (sq-ft)	Storage (cubic-feet)	Elevation (feet)	Surface (sq-ft)	Storage (cubic-feet)
1,178.00	90,440	0	1,183.30	107,093	522,989
1,178.10	90,747	9,059	1,183.40	107,416	533,714
1,178.20	91,055	18,149	1,183.50	107,740	544,472
1,178.30	91,362	27,270	1,183.60	108,063	555,262
1,178.40	91,669	36,422	1,183.70	108,386	566,085
1,178.50	91,976	45,604	1,183.80	108,709	576,939
1,178.60	92,283	54,817	1,183.90	109,033	587,827
1,178.70	92,591	64,061	1,184.00	109,356	598,746
1,178.80	92,898	73,335	1,184.10	109,687	609,698
1,178.90	93,205	82,640	1,184.20	110,019	620,683
1,179.00	93,513	91,976	1,184.30	110,350	631,702
1,179.10	93,820	101,343	1,184.40	110,682	642,754
1,179.20	94,127	110,740	1,184.50	111,013	653,838
1,179.30	94,434	120,168	1,184.60	111,345	664,956
1,179.40	94,742	129,627	1,184.70	111,676	676,107
1,179.50	95,049	139,117	1,184.80	112,008	687,291
1,179.60	95,356	148,637	1,184.90	112,339	698,509
1,179.70	95,663	158,188	1,185.00	112,671	709,759
1,179.80	95,970	167,769	1,185.10	113,002	721,043
1,179.90	96,278	177,382	1,185.20	113,333	732,360
1,180.00	96,585	187,025	1,185.30	113,665	743,710
1,180.10	96,900	196,699	1,185.40	113,996	755,093
1,180.20	97,216	206,405	1,185.50	114,328	766,509
1,180.30	97,531	216,142	1,185.60	114,659	777,958
1,180.40	97,846	225,911	1,185.70	114,991	789,441
1,180.50	98,161	235,712	1,185.80	115,322	800,956
1,180.60	98,476	245,543	1,185.90	115,654	812,505
1,180.70	98,792	255,407	1,186.00	115,985	824,087
1,180.80	99,107	265,302	1,186.10	116,322	835,702
1,180.90	99,422	275,228	1,186.20	116,660	847,351
1,181.00	99,738	285,186	1,186.30	116,997	859,034
1,181.10	100,053	295,176	1,186.40	117,335	870,751
1,181.20	100,368	305,197	1,186.50	117,672	882,501
1,181.30	100,683	315,249	1,186.60	118,010	894,285
1,181.40	100,999	325,333	1,186.70	118,347	906,103
1,181.50	101,314	335,449	1,186.80	118,685	917,955
1,181.60	101,629	345,596	1,186.90	119,022	929,840
1,181.70	101,944	355,775	1,187.00	119,360	941,759
1,181.80	102,259	365,985	1,187.10	119,697	953,712
1,181.90	102,575	376,227	1,187.20	120,034	965,699
1,182.00	102,890	386,500	1,187.30	120,372	977,719
1,182.10	103,213	396,805	1,187.40	120,709	989,773
1,182.20	103,537	407,143	1,187.50	121,047	1,001,861
1,182.30	103,860	417,512	1,187.60	121,384	1,013,982
1,182.40	104,183	427,915	1,187.70	121,722	1,026,138
1,182.50	104,507	438,349	1,187.80	122,059	1,038,327
1,182.60	104,830	448,816	1,187.90	122,397	1,050,549
1,182.70	105,153	459,315	1,188.00	<b>122,734</b>	<b>1,062,806</b>
1,182.80	105,476	469,847			
1,182.90	105,800	480,410			
1,183.00	106,123	491,007			
1,183.10	106,446	501,635			
1,183.20	106,770	512,296			

Peak water storage and elveation

2-foot freeboard

STATE OF MAINE  
DEPARTMENT OF AGRICULTURE, CONSERVATION & FORESTRY  
LAND USE PLANNING COMMISSION

IN THE MATTER OF )  
REZONING PETITION ZP 779A ) PRE-FILED DIRECT TESTIMONY  
WOLFDEN MT. CHASE, LLC ) OF WOLFDEN MOUNT CHASE, LLC

VOLUME III OF IV  
(Testimony of Ronald Little, Brian LeBlanc, Sean Fieler)

## **INDEX OF WITNESSES AND EXHIBITS**

### **VOLUME I**

#### **JEREMY OUELLETTE**

Pre-Filed Direct Testimony

- Exhibit A Chapter 200 Summary
- Exhibit B Statements from CLF and NRCM on Maine’s mining law
- Exhibit C Figure 2-1 conceptual site plan
- Exhibit D LUPC Guidance for Interpreting 2010 CLUP, October 5, 2012
- Exhibit E Summary of Wolfden Community Engagement
- Exhibit F Town of Hersey Mining Ordinance and Special Town Minutes from October 6, 2022
- Exhibit G Town of Patten – Special Town Meeting Minutes, April 13, 2023
- Exhibit H Town of Sherman – Resolution in Support of Wolfden Resources, April 4, 2023
- Exhibit I Town of Stacyville – Resolution in Support of Wolfden Resources, January 18, 2023
- Exhibit J Moro Plantation – Special Town Meeting Minutes, December 14, 2022
- Exhibit K Passamaquoddy THPO Comments to LUPC
- Exhibit L Maine Geological Survey Comments to LUPC

#### **DOUGLAS STEWART**

Pre-Filed Direct Testimony

- Exhibit A Curriculum Vitae
- Exhibit B Wolfden Regional Location Map
- Exhibit C Penobscot River Watershed Map
- Exhibit D Correspondence with MDIFW, September 25, 2023

#### **GEMMA-JAYNE HUDGELL**

Pre-Filed Direct Testimony

- Exhibit A Curriculum Vitae
- Exhibit B Northeast Archaeological Research Center Archaeological Phase 0 Assessment

### **VOLUME II**

#### **MARK PETERS**

Pre-Filed Direct Testimony

- Exhibit A Curriculum Vitae
- Exhibit B Wood (now WSP) Technical Memorandum

#### **BRIAN DANYLIW & PAUL THOEN**

Pre-Filed Direct Testimony

- Exhibit A Curriculum Vitae Danyliw

Exhibit B Curriculum Vitae Thoen  
Exhibit C Mine Water Service Water Treatment Report

**LISA TURNER**

Pre-Filed Direct Testimony

Exhibit A Curriculum Vitae  
Exhibit B Sevee & Maher Engineers Technical Memorandum, December 19, 2022  
Exhibit C Sevee & Maher Engineers Response to LUPC Comments, April 12, 2023  
Exhibit D Spray Irrigation Systems and Equipment  
Exhibit E Snowmaking Systems and Equipment

**JIM FINLEY**

Pre-Filed Direct Testimony

Exhibit A Curriculum Vitae

**DON DUDEK**

Pre-Filed Direct Testimony

**VOLUME III**

**RONALD LITTLE**

Pre-Filed Direct Testimony

**BRIAN LeBLANC**

Pre-Filed Direct Testimony

Exhibit A Curriculum Vitae  
Exhibit B Overview of AMPL  
Exhibit C Preliminary Economic Assessment Cover Page and Table of Contents

**SEAN FIELER**

Pre-Filed Direct Testimony

**VOLUME IV**

**MICHAEL LeVERT**

Pre-Filed Direct Testimony

Exhibit A Curriculum Vitae  
Exhibit B Economic Assessment of the Proposed Project, November, 2022



**TERRY THURSTON-HILL**

Pre-Filed Direct Testimony

STATE OF MAINE  
DEPARTMENT OF AGRICULTURE, CONSERVATION & FORESTRY  
LAND USE PLANNING COMMISSION

IN THE MATTER OF	)	Pre-Filed Direct Testimony of Brian
REZONING PETITION ZP 779A	)	LeBlanc on Behalf of Wolfden Mt.
WOLFDEN MT. CHASE, LLC	)	Chase, LLC

On behalf of Wolfden Mt. Chase, LLC (“Wolfden”), Brian LeBlanc is submitting this pre-filed direct testimony in support of ZP 779A.

**I. QUALIFICATIONS AND EXPERIENCE**

I am the President and co-founder of A-Z Mining Professionals Limited (AMPL), which is an independent consulting agency that has extensive experience in auditing of mining practices and preparing technical reports in accordance with Canada’s strict rules and guidelines for mineral properties. I am also President and CEO of Core Mining Group, which consists of experienced mining professionals with expertise in mine construction and operation. Core Mining Group can provide project and operations management expertise as part of an owner’s team. When seeking project financing this provides our clients with the ability to present a highly qualified and competent project delivery team. Core then works with clients, mine finance groups and alternative project financing organizations to help to secure project implementation funding

Previously, I worked in senior operational roles at the Williams Mine in Hemlo, Ontario; Kubaka Mine in Far East Russia; and Grasberg in Indonesia. I have also managed engineering departments, led underground mining development projects, and managed mining feasibility studies. I am a licensed Professional Engineer in the Province of Ontario, Canada, with over 45 years of industry experience across Canada and internationally. My commodity experience

includes iron ore, base metals, and precious metals (gold and PGMs) utilizing open pit, narrow vein and bulk underground mining methods.

I am an Honours graduate in both Mining Technology from the Haileybury School of Mines (1981) and in Mine Engineering from Michigan Technological University (1986). I am a member of the Professional Engineers of Ontario and am a designated Qualified Person as defined by NI 43-101 guidelines under the National Instrument 43-101.

The purpose of National Instrument 43-101 is to ensure that misleading, erroneous or fraudulent information relating to mineral properties is not published and promoted to investors on the stock exchanges overseen by the Canadian Securities Authority. The NI 43-101 was created after the Bre-X scandal to protect investors from unsubstantiated mineral project disclosures. It is a codified set of rules and guidelines for reporting and displaying information related to mineral properties owned by, or explored by, companies which report these results on stock exchanges within Canada. This includes foreign-owned mining entities who trade on stock exchanges overseen by the Canadian Securities Administrators, even if they only trade on Over The Counter (OTC) derivatives or other instrumented securities.

The National Instrument 43-101 is broadly comparable to the Joint Ore Reserves Committee Code (JORC Code) which regulates the publication of mineral exploration reports on the Australian Stock Exchange (ASX). In many cases, NI 43-101 and JORC Code technical reports are considered inter-changeable and may be accepted by either regulatory body in cases of dual listed entities and, indeed, are accepted as the de facto industry reporting standard by many other jurisdictions which lack similar rigorous reporting standards or internationally recognized industry professional bodies.

My curriculum vitae is attached as Exhibit A, and an overview of AMPL is attached as Exhibit B.

## **II. INVOLVEMENT WITH THE PICKETT MOUNTAIN PROJECT**

In March 2020, A-Z Mining Professionals Ltd. (AMPL) was asked to submit a Proposal to conduct a Preliminary Economic Assessment (PEA) on the Pickett Mountain Project.

Previously AMPL had worked on a several projects for Wolfden Resources Corporation. In 2015 AMPL completed a Scoping Study on the Murray Brook polymetallic Project near Bathurst New Brunswick and an Internal Scoping Study on the Clarence Stream gold Project in Charlotte County, New Brunswick. As well, AMPL completed a Resource Estimation Report on the Pickett Mountain Project in 2018/19. A typical resource estimation involves the construction of a geological and resource model with data from various sources that is used to determine and define the resource tonnage and grade of a geological deposit.

AMPL began work on the Pickett Mountain PEA in May of 2020, completing the work in the Fall of 2020. Subsequently, I was involved in updating costs after the processing plant relocation in December of 2022. The PEA is Attachment 14-A to the application and, due to its size, only the cover and table of contents is attached here as Exhibit C.

## **III. PRELIMINARY ECONOMIC ASSESSMENT**

### **A. Overview of Preliminary Economic Assessments**

The preliminary economic assessment (PEA), often referred to as scoping study, is typically the first analysis of the technical feasibility and economic viability of a proposed mining project. Canadian National Instrument (NI) 43-101 defines a PEA as follows:

“Preliminary economic assessment means a study, other than a pre-feasibility study or feasibility study, that includes an economic analysis of the potential viability of mineral resources.”

Companion Policy 43-101CP to NI 43-101 notes that: “A preliminary economic assessment might be based on measured, indicated, or inferred mineral resources, or a combination of any of these. We consider these types of economic analyses to include disclosure of forecast mine production rates that might contain capital costs to develop and sustain the mining operation, operating costs, and projected cash flows.”

The principal purpose of a PEA is to determine whether a mineral deposit has a reasonable prospect of being economically mineable and, if so, to make concrete recommendations as to the further work required to advance the project towards a production decision. Typically, the preliminary economic assessment will define whether the deposit will be mined by open pit or underground methods and will include preliminary mine designs and equipment requirements. It will also typically define the most appropriate processing methods by which a saleable mineral commodity would be produced from the raw mined ore, based on a reasonable amount of metallurgical test work, and the general requirements for service facilities and infrastructure. Capital expenditures to build the project, and the subsequent operating costs associated with mining, processing, services and administration, and, if appropriate, smelting and refining, will be estimated from preliminary designs, working drawings and sketches, typically to an accuracy of plus or minus 30% to 40%.

A unique feature of the PEA is that it is permissible to include inferred resources within the mining and processing production plans, provided that appropriate cautionary language is included with respect to the geologically speculative nature of those inferred resources. The standard language used for this purpose is: “This preliminary economic assessment is based, in part, on inferred resources which are considered too speculative geologically to have the economic considerations applied to them that would enable them to be categorized as mineral



reserves. This preliminary economic assessment is preliminary in nature and there is no certainty that the results of the preliminary economic assessment will be realized.”

Ultimately, a PEA report is an early measure of the potential economic outlook of a potential mining project, based on limited work and general assumptions regarding mining, processing and costs. A PEA report will guide decisions as to whether or not to expend more money advancing the project towards production and will assist in defining the future work to be conducted on the project. Once a company completes a positive PEA the next step would be to move to a Prefeasibility Study (PFS) and then a Feasibility Study (FS). Each step in the process focuses more and more on the details of the project, and each is subject to the requirements of NI 43-101.

#### **B. Development of the Pickett Mountain PEA**

The PEA here includes a great deal of information, ranging from the setting to history of exploration at the site to likely mining infrastructure. That information is evaluated to determine the key sections of the PEA—the recommended mining methods (Section 16) and the cost/economics evaluation (Sections 21 and 22). The mining methods section discusses the current or proposed mining methods and provides a summary of the amenability or potential amenability of the mineral resources or mineral reserves to the proposed mining methods. That evaluation includes geotechnical, hydrological, and other parameters relevant to mine plans; production rates, expected mine life, mining unit dimensions and mining dilution factors used; requirements for underground development and backfilling; and required mining fleet and machinery.

Many capital and operating cost variables are then correlated with mining methods in Section 21 to arrive at assumptions of pre-operation development costs, operational costs, and

reclamation and closure costs over the life of the project. Normally, the accuracy range of projected costs in a PEA is in the + or- 40% range. In the case of the Wolfden PEA, AMPL was aware that this Project would be a test case for mining in the State of Maine, so we provided tighter cost estimates in the areas of the PEA for which we were responsible. All costs associated with mining were developed from first principles based on current (2020) costs.

The labour costs included in the analysis were based on contract labour costs being paid at another underground project we worked on in Arizona. The materials costs were based on quoted costs from U.S. suppliers. Infrastructure and equipment costs were based on bids provided by suppliers. All these costs were used to develop the capital costs for the Project as well as the operating costs for the Project. The costs AMPL developed would have satisfied the requirements for a Feasibility level of study with an accuracy of 10-15%.

The Project costs were then evaluated in Section 22 against expected long term metal prices, based on industry consensus, to determine financial viability. One thing to note is that in this analysis we had 50% Inferred Resources and 50% Indicated Resources. Inferred Resources are estimated based on geological evidence and limited sampling and reasonably assumed, but not verified, geological and grade continuity. In contrast, Indicated Resources are simply economic mineral occurrences that have been sampled (from locations such as outcrops, trenches, pits and drill holes) to a point where an estimate has been made, at a reasonable level of confidence, of their contained metal, grade, tonnage, shape, densities, and physical characteristics. Inferred Mineral Resources are considered too speculative geologically to have economic considerations applied to them that would enable them to be categorized as “Mineral Reserves.” Mineral Resources that are not mineral reserves do not have demonstrated economic

viability; therefore, there is no guarantee that the economic projections contained in this Preliminary Economic Assessment would be realized.

### **C. Conclusions from the Pickett Mountain PEA**

The Pickett Mountain Project is a polymetallic deposit with a diluted mineral resource of 4.2 million tonnes at 8.56% zinc, 1.11% copper, 3.4% lead, .79 g/t gold, and 88.8 g/t silver.

Based on the analysis in the PEA, AMPL concluded the following:

1. The Project provides positive returns based on the parameters and metal prices used in this study and should be developed further with the aim of bringing the deposit to production.
2. The Project would be considered a small to medium sized underground mining operation, which can be developed for production at a reasonable cost in a near-term horizon, provided regulatory approval and permits are acquired.
3. The mined grade of potentially economic mineralisation is an important variable for the success of the operation as are operating costs. Operating management efforts during mine production must be focused on these parameters.

In December 2022 AMPL was asked to look at the effect relocating the processing facilities (the mill and associated tailings facility) would have on the Cash Flow model and financial viability. Capital costs remained the same for the mill, a second water treatment plant was added to the capital, and \$5.69/tonne was added to the operating costs to transport the ore from the mine site to the new mill location. The result was that the Pre-Tax IRR was reduced by 2% and the After-Tax IRR was also reduced by 2%. The Project was still considered a “robust” Project with good returns. Attached as Exhibit D is the 2022 Mill Relocation Update that reflects the change in location of the mill. The Mill Relocation Update has not been adjusted to reflect the most current metal prices, which have improved over the prices used in the 2020 PEA.

The table below illustrates the financial viability of the Project. The 2020 metal prices were used for the original PEA and the 2022 Mill Relocation Update. The third column is the

current (August 31, 2023) metal prices. The financial viability of the Project remains strong and is not substantially affected by the relocation of the processing facility. It is one of the more financially viable projects that AMPL has worked on and has been strengthened based on current metal prices.

METAL PRICES	2020 PEA		2022 Mill Relocate		Aug. 31/23 & MR.
Zinc ( US \$ / pound )	\$ 1.15		\$ 1.15		\$1.09
Copper ( US \$ / pound )	\$ 3.00		\$ 3.00		\$3.80
Lead ( US \$ / pound )	\$ 1.00		\$ 1.00		\$1.00
Gold ( US \$ / ounce )	\$ 1,500.00		\$ 1,500.00		\$1,939
Silver( US \$ / ounce )	\$ 18.00		\$ 18.00		\$24.41
<b>PRE-TAX NPV</b>					
Discounted at 5 % / year	\$ 305,181,000		\$ 283,182,000		<b>\$305,780,000</b>
Discounted at 8 % / year	\$ 238,056,000		\$ 219,737,000		<b>\$238,600,000</b>
Discounted at 15 % / year	\$ 132,537,000		\$ 120,078,000		<b>\$132,983,000</b>
<b>PRE-TAX IRR</b>	<b>40%</b>		<b>38%</b>		<b>40%</b>
<b>AFTER-TAX NPV</b>					
Discounted at 5 % / year	\$ 255,533,000		\$ 237,017,000		<b>\$256,107,000</b>
Discounted at 8 % / year	\$ 198,299,000		\$ 182,718,000		<b>\$198,824,000</b>
Discounted at 15 % / year	10810500000%		\$ 97,262,000		<b>\$108,539,000</b>
<b>AFTER-TAX IRR</b>	<b>37%</b>		<b>35%</b>		<b>37%</b>

Dated: SEPT 21/20

Brian LeBlanc  
Brian LeBlanc

Province of Ontario

Date: SEPT 21/23

Personally appeared before me the above named Brian LeBlanc, who, being duly sworn, did testify that the foregoing testimony was true and correct to the best of his knowledge and belief.

Before me,

[Signature]  
Notary Public  
My commission expires: N/A

Kimberly Megan Zyla  
Commissioner for Taking Affidavits,  
Province of Ontario  
Licensed Paraiegal LSO #P16970





# **EXHIBIT A**



## **BRIAN C. LEBLANC, P.ENG.**

781 Community Hall Road  
Thunder Bay, ON P7G 1M6

Phone: (807) 632-8833 ♦ email: [brian.leblanc777@gmail.com](mailto:brian.leblanc777@gmail.com)

---

### **PROFESSIONAL ENGINEER**

More than 35 years of experience in roles of increasing responsibility and leadership.

#### *Areas of expertise:*

- ♦ Operations Management
- ♦ Project Management
- ♦ Engineering
- ♦ Administration

*A team player with a solid track record in operations management, safety, mine design, planning, geotechnical engineering, cost control, major engineering projects, team building, training and change implementation.*

---

### **PROFESSIONAL EXPERIENCE**

#### **A – Z MINING PROFESSIONALS LIMITED**

**March 2014 – Present**

##### **President**

AMPL is a company of mining professionals, each with over a quarter century of mining industry experience worldwide. The Principals and Associates of AMPL bring a collective knowledge of geological modeling, mine design and engineering, underground and open pit mining, mineral processing, environmental permitting, mine closure, operations management and economic analysis to every project. AMPL is familiar with managing project(s) involving multiple tasks for a client or a number of client representatives.

#### **CORE MINING GROUP LIMITED**

**February 2015 – Present**

##### **President and CEO**

Core Mining Group Ltd. consists of highly competent mining professionals with extensive expertise in mine construction and operations. Each Principal of the company has at least 30 to 35 years of mine operations expertise and experience. This includes roles as senior management at head office and site, all levels of mine management and supervision, mining and technical services (engineering, geology, processing, safety, etc.) functions, construction and construction management. Many on our team have experience working for mining contractors in a variety of roles and responsibilities.

Core can provide its project and operations management groups' expertise as part of an owner's team. When seeking project financing this provides our clients with the ability to present a highly qualified and competent project delivery team.



**NORDPRO MINE AND PROJECT MANAGEMENT SERVICES LTD.**

**April 2010 – February 2014**

**President**

**Vice President and General Manager**

Built an engineering management firm focused on providing a complete package of mine or project management services to clients within the mining industry. NordPro's clients required proven managers and technicians in the field to support their projects and mining operations so the focus was to hire based on industry experience backed by a record of accomplishment. With success in seconding personnel to project sites the scope of NordPro was expanded to include engineering studies and mine design as well as environmental management and permitting.

Successfully grew the company and recruited personnel, expanded from one to 24 direct employees and developed strong working relationships with Senior Associates. Business sales exceeded \$6 million in year 4 of operation.

- Permitting and Environmental services from initial permitting to final plant closure. NordPro has worked on Environmental Consultation and Permitting applications for Vale, Gold Bullion Development Corporation, Harte Gold Corporation and Treasury Metals Ltd.
- Geological modeling services and engineering services from initial studies to detailed design, mine planning and scheduling and ongoing capital or maintenance upgrades. NordPro has managed PEA's for Harte Gold, KWG Resources, Inspiration Mining, Rockex and Carlisle Goldfields as well as Feasibility Studies for Critical Elements Corporation and Stillwater Canada.
- Source and provide skilled personnel to our clients in the areas of engineering, geology, mine operations and project management services. NordPro project teams have worked for North American Palladium Ltd., Gold Corp. Musselwhite Mine, Gold Corp. Red Lake Mines and Rubicon Minerals Ltd.

**NORTH AMERICAN PALLADIUM LTD.**

**August 2007 – April 2010**

**Project Manager – Ontario Projects**

Responsible to the Vice President of Operations for the Shebandowan West Advanced Exploration Project and the Offset High Grade Zone Underground Mine Project.

- Conducted consultations with Government Ministry officials, local First Nations and Local Stakeholders. Completed all necessary environmental and operational permitting.
- Designed and constructed the mine site and took the project from a green-fields project to an underground development project in 9 months. Established a portal and completed ~580m of ramp development, accessed the ore zone and extracted a bulk sample for metallurgical testing.
- Completed Pre-feasibility study on the Shebandowan West Project in association with SRK Engineering. Project is currently inactive due to low metal prices. Modular site has been dismantled and moved to Thunder Bay.
- Completed a Scoping Study on the Offset High Grade Zone at the Lac Des Isles Mine site.



**PT REDPATH INDONESIA – Grasberg Mine Site**

**January 2006 – September 2007**

**Project Manager/Tunnel Superintendent for CIP/Lower Big Gossan Development Project:**

Responsible to the Redpath Site Manager and/or General Superintendent to manage the CIP (Common Infrastructure Project) Tunnel development and the Lower Big Gossan Mine development project in a safe and efficient manner. Supervised a mixed workforce of expatriate and national labour to meet safety, quality and production requirements.

**Rotational General Superintendent/Tunnel Superintendent**

Responsible to the Redpath Site Manager and/or General Superintendent to fill in as a replacement for the General Superintendent and other Tunnel Superintendent's as required. Responsible to maintain safety, quality and production requirements while supervising a mixed workforce of expatriate and national workers, engineers and technicians. Areas of responsibility included the Big Gossan Mine development project, the Grasberg Underground Mine development project and the Common Infrastructure Project.

- Reviewed Big Gossan feasibility study and reported findings and suggested improvements to Redpath and Freeport management.

**NORTH AMERICAN PALLADIUM – Lac Des Isles Mine**

**November 2004 – January 2006**

**Superintendent of Technical Services**

Responsible to the Mine Manager for providing technical support to the mine site in the areas of mine planning, ventilation, ground control, water management, civil/construction engineering, surveying, mine statistics, geology and mineral inventory management. Directed a team of 17 professional and technical staff.

- Conducted geotechnical review of underground mine plan and redesigned the underground mine to ensure stability and maximize ore recovery.
- Co-ordinated design and construction of main ventilation system, compressor house, underground services and facilities and dry/office complex for the new underground mine. Worked closely with on site personnel and consultants.
- Designed rockfall safety systems to support a 40 m high wall prior to collaring three underground portals.
- Integrated open pit and underground engineering groups to form one "team" while expanding both groups as required. Training, developing and mentoring younger engineering personnel.

**Project Engineer:** Nov/Dec. 2004

Responsible to the Mine Superintendent and providing technical expertise in mine design, contractor supervision and project management.

- Set up the Scope of Work, evaluated bids and selected and supervised an underground development contractor.



**OMOLON MINING COMPANY/KINROSS GOLD CORPORATION – Kubaka Project 2003 – June 2004**

**Manager of Mining Operations**

Responsible to the Mine Manager for developing underground mining practices, achieving production targets and implementing safety and training initiatives for the underground workforce.

- Developed mining plans for two small narrow vein orebodies.
- Increased safety awareness within the underground workforce.
- Worked closely with McIntosh Engineering on Feasibility Study for Tsokol Zone orebody.
- Improved mining practices in the Kubaka underground leading to increased productivity levels

**WILLIAMS OPERATING CORPORATION – Williams Mine**

**1986 – 2003**

**Mine Superintendent, 2001 - 2003**

Responsible to the Mine Manager for achieving production targets safely, within budgeted costs and to implement changes to improve the mine's operating efficiencies and competitiveness. Directed a team of 265 hourly and 24 operating staff. Administered contracts for underground development and construction.

- Motivated the underground workforce to achieve the best safety record in the history of the operation in 2002 with a Total Medical Injury Frequency of 4.2.
- Reduced total underground workforce by 9% while maintaining or improving operating efficiencies.
- Reduced development manpower by 20%, reorganized crew sizes and increased efficiencies by 45%.
- Improved stope cycle times by 60% from 200 to 320 tonnes per day.
- Reduced backfill void by 20% and placed a record tonnage of fill in 2002.
- Reduced overtime from 8% to 5% saving \$800K annually.

**Superintendent of Engineering & Geology, 1996 – 2000**

Responsible to the Mine Manager for providing technical support to the mine site in the areas of mine planning, ventilation, ground control, environmental control, water management, civil/construction engineering, surveying, mine statistics, geology and mineral inventory management. Directed a team of 32 professional and technical staff.

- Trained and developed an inexperienced group of young engineers into a flexible, cohesive team.
- Developed and implemented a panel mining method which better controlled ground stability in high stress areas.
- Worked closely with a geotechnical consultant in pioneering the use of SMART cable technology and screen reinforced shotcrete as a ground support technique.
- Discovered an error in the water management protocols & obtained approval to immediately begin an \$8 million tailings dam construction project which was completed on time and under budget.
- Initiated the installation of a mine wide seismic system which improved both workforce morale and safety by providing real time geotechnical information on micro seismic events.
- Developed contingency mining plans to achieve budgeted production targets related to disruptions following a major seismic event.





### **1<sup>st</sup> Line Supervisor/Mine General Foreman, 1990 – 1996**

Supervised crews in all areas of mine operation, services, production and development.

- Established a reputation for motivating crews to achieve high performance in both safety and production. Crews twice achieved 40,000+ hours without a medical injury. One development crew worked 14 months without a medical injury.

### **Underground Project and Development Engineer, 1987 – 1990**

Managed the engineering, planning and construction of much of the underground infrastructure.

Major projects:

- Mine Crushing and Rock Handling Systems
- U/G Backfill Systems
- Main Ventilation Systems
- Ore Bin Excavation and Lining
- Process Water and Dewatering Systems
- U/G Maintenance Shop Complexes

Planned & scheduled successful completion of 3 internal ore pass systems, 25,000 m of lateral development and 4,000 m of internal ramp systems. Supervised and worked closely with contractor.

NANISIVIK MINES LTD.:	<b>Mine Technician</b>	1981 – 1984
SHERMAN MINE:	<b>Surveyor/Draftsman</b>	1980 – 1981
STEEP ROCK IRON MINES:	<b>Surveyor/Crusher</b>	1976 – 1978
GIANT YELLOWKNIFE MINES:	<b>Ball Mill/Flotation Operator</b>	1974 – 1975

## **EDUCATION & PROFESSIONAL DEVELOPMENT**

MICHIGAN TECHNOLOGICAL UNIVERSITY  
**Honours BSc., Mining Engineering, 1986**

HAILEYBURY SCHOOL OF MINES  
**Technical Diploma, 1981**

Basic, Advanced and Management Mine Rescue Training

Management Certification for Ontario Joint Health and Safety Committee

### **ASSOCIATIONS**

Professional Engineers of Ontario

### **INTERESTS**

Fishing, Carpentry, Golfing, Reading

## **EXHIBIT B**



## **A-Z MINING PROFESSIONALS LIMITED**

AMPL is a company of highly qualified and experienced professional mining geologists and engineers, each with over a quarter century of industry experience worldwide, in underground and open pit mining. The Principals of AMPL bring recognized and extensive expertise in all aspects of mining projects evaluation and implementation. The group also can provide project management and operations management turnkey solutions to projects. Our team has experience working in base metals, gold, silver, platinum group metals, iron ore, molybdenum, uranium, diamonds, chromite, rare earths and other mineral projects in Canada and internationally.

With our studies, we strive to provide our Clients with considerations and recommendations that are appropriate for the successful design and construction of their projects. AMPL is independent with no commercial affiliations, an attribute that ensures wide acceptance of its reports and recommendations by the mining, banking and investment sectors. AMPL ensures that at all times it is providing non-conflicted and totally independent services and analysis to its clients.

For interested clients, AMPL works with contacts within the financial community as well as alternative sources of capital funding to assist the client in seeking project implementation funding for viable projects.

### **MINING STUDIES & PROJECT MANAGEMENT**

The key services offered by AMPL include exploration geology, resource modelling including block model construction and validation, geo-statistics and mine engineering as well as financial and economic analysis consulting commencing at the project conceptualization and initial evaluation stage through to complete mine design, planning and scheduling, equipment selection, rock mechanics, metallurgical testwork and processing plant design, infrastructure, environmental permitting, mine closure and capital and operating costs estimating. The group has extensive experience in auditing of mining practices, environmental permitting and compliance reviews, metallurgical reviews, conducting due diligence on projects and the preparation of technical reports in accordance with NI 43-101 Standards of Disclosure for Mineral Projects. AMPL personnel have worked on hundreds of studies ranging from Internal Scoping Studies to Preliminary Economic Assessments (PEA), Pre-Feasibility Studies (PFS) and full Feasibility Studies for clients. The Principals of AMPL are all registered Professionals and Qualified Persons under NI 43-101 guidelines.



For software AMPL uses Minesight™ for all geological modeling work and for all open pit optimization and design, AutoCAD™ and Promine™ for all underground design work. All reports are prepared in Microsoft Word, spreadsheets in Excel, schedules in Excel and Project and presentations in PowerPoint™.

AMPL is familiar with managing project(s) involving multiple tasks for a client or a number of client representatives. A single point of contact is always assigned for the client by AMPL. This point of contact will be the Project Manager. The Project Manager will ensure regular study updates (timing as agreed) verbally and written are provided to the client.

## THE AMPL TEAM

The capabilities and experience of team members are provided in the following brief career biographies.

***Mr. Brian LeBlanc, P.Eng.  
President and Project Manager***

Brian LeBlanc, President, has over 45 years of industry experience with the majority of his career applied to mine operations at the Williams Mine in Hemlo, Kubaka Mine in Far East Russia, Grasberg in Indonesia and Lac des Iles in Ontario. A graduate in mining engineering from Michigan Technological University (1986) and Mining Technology at the Haileybury School of Mines (1981) Brian has also managed engineering departments, feasibility studies and was employed by mine contractors before starting an engineering consultancy in Thunder Bay, Ontario. His commodity experience includes iron ore, base metals and the precious metals gold and PGMs utilizing open pit and narrow vein and bulk underground mining methods. At Williams Mine, Brian made numerous operational and cost improvements as he rose to the Mine Superintendent role. Brian is a member of PEO and a Qualified Person under NI 43-101 Guidelines.

***Mr. Malcolm Buck, P.Eng.  
Principal Mining Engineer – Financial Modelling***

Malcolm Buck is a professional mining engineer with over 30 years of diverse engineering and operations experience, in Canada and around the world. He obtained a Bachelor of Mining Engineering from the Technical University of Nova Scotia (now Dalhousie University) in 1983 and a Master of Engineering – Mineral Economics from McGill University in 1986. He has extensive expertise in feasibility studies preparation and mine projects engineering/management in addition to expertise in performing company and mineral project valuations, technical due diligences and strategic planning activities. He has worked on base metal, gold, platinum group metals, iron ore, molybdenum, uranium and other mineral projects. Malcolm specializes in the design and



implementation of mine operations control systems and Management Information Systems for underground mining. Malcolm is a member of PEO and a Qualified Person under NI 43-101 Guidelines.

***Mr. Eric Hinton, P. Eng. FCIM***

***Principal Mining Engineer – Project Management, Mine Design and Mining Technology***

Eric Hinton is a professional mining engineer with over 30 years of underground and open pit mining experience. He is a technically-minded, internationally respected, challenge-driven senior professional with an exemplary record of staying on the leading edge of mining techniques. Eric is committed to excellence in all facets of the mining business and delivers outstanding results in an environment of on-going change and diversity. He is capable of efficiently and effectively prioritizing a broad range of responsibilities to consistently meet tight deadlines and mandates. Eric has worked in both technical services and operations for companies such as Vale, Goldcorp and Rubicon and as a consulting engineer with firms such as Golder Associates and Boge and Boge. Eric has diplomas from the Haileybury School of Mines, Queen's University (B.Sc.) and Laurentian University (M.A.Sc.). He is a member of the Professional Engineers of Ontario, Association of Professional Engineers and Geoscientists of the Province of Manitoba and a Fellow of the Canadian Institute of Mining and Metallurgy and is a designated Qualified Person as defined by NI 43-101 guidelines.

***Darryl Boyd, H.BSc., Principal: Manager Environmental and Regulatory Affairs***

Darryl Boyd has been employed in the mining sector for 15 years as an operator and as a consultant. Darryl has scoped and managed assignments by multi-disciplinary teams that have included air/acoustic specialists, chemists, geochemists, hydrologists, hydro-geologists, engineers, biologists, archaeologists and lawyers. Darryl has a thorough knowledge of all environmental regulations at the federal, provincial and municipal levels and is an expert in environmental permitting. As an operator, Darryl has completed the permitting for several project start-ups and assisted with project execution. As a consultant, Darryl has initiated the permitting for several (15 to date) project start-ups and facilitated handovers to project proponents to finish using in-house staff. Darryl is also experienced at liaising with regulatory officials, local interest groups and first nations groups and ensures that the best interests of the client are always at the forefront.





## **ASSOCIATES:**

### **John Corkery, PhD., P. Geo.**

Dr. John Corkery is a Senior Geologist with more than 20 years of experience analyzing micro and macro trends to discover platinum-group element (PGE), copper, nickel, gold, and zinc. Results-driven executive with the proven ability to develop exploration strategies based on the global commodities market utilizing geographic information systems (GIS). Experienced professional performing due diligence while developing mining strategies to ensure adherence with environmental rules and regulations. Accomplished leader pitching mining projects to corporate and investment bankers to secure multimillion dollar project budgets.

### **Mr. Finley Bakker, P. Geo**

Mr. Finley Bakker is a seasoned Professional Geoscientist with over 40 years of experience leading geological and engineering teams in the mining industry. With expertise in both underground and open pit operations, has a proven record of resource and reserve estimation and expansion. Has provided extensive consulting services for various projects and organizations.

- Leadership and mentorship of successful technical teams
- Resource and reserve calculations and expansions
- Underground VMS deposits (Copper, Zinc, Silver, Gold, Lead),
- Open pit Porphyry Molybdenum, Skarn Tungsten
- Narrow Vein Gold deposits and Rare Earth Elements and Metals
- Medsystem™ (Compass)/Minesight/Hexagon implementation
- Supervising diverse teams both technical and general work force

### **Mr. John Sferrazza, BSc., President, Environmental Applications Group**

Mr. John Sferrazza has been providing environmental consulting services to industry, municipalities and commercial enterprises for over 30 years. His expertise lies mainly in the area of impact assessments; environmental effects monitoring, study design preparation and baseline environmental assessments. John is an experienced fisheries biologist and senior project manager at EAG with a vast amount of experience in environmental impact study design and implementation at metal mining, pulp and paper, petrochemical and other industrial sites. John also has a wealth of experience in environmental permitting and has a thorough knowledge of all environmental regulations at the federal, provincial and municipal levels. John is also experienced at liaising with regulatory officials so that the best interests of the client are always at the forefront.



***Mr. John Eggert, P. Eng., Associate  
Consulting Specialist: Metallurgy and Mineral Processing***

Mr. John Eggert is a contract minerals process engineer with experience in gold, base metals, industrial minerals and environmental issues with over 30 years of experience. John's specialties include gold metallurgy, base metal mineral processing, plant design, in plant trouble shooting and commissioning. John is considered a Qualified person as defined by Ni 43-101 guidelines.

***Rock Eng  
Dr. Kathy Kalenchuk, Ph.D., P. Eng.***

Rock Eng provides high-end expertise in rock engineering and geomechanics to the mining and civil engineering industries around the world. Based in Kingston Ontario, the company started out in 2010 under the name Mine Design Engineering (MDEng) but was rebranded in 2019 to RockEng to better reflect the global services they provide.

RockEng personnel bring an exceptional level of skill and experience to your projects and make use of the latest engineering techniques, knowledge and information. They can provide up-to-date and appropriate technology solutions to your problems. RockEng personnel are experts in underground mine design, ground control methods and technologies, open pit slope design, geotechnical engineering, Geotechnical logging of the drill core, interpretation of geotechnical data, preliminary domain delineation and kinematic assessment of stope stability.

***Bawden Engineering Ltd.,  
Dr. Will Bawden, Ph.D., P. Eng,***

International expert in Rock Mechanics and Geotechnical Design  
Former Chair of the Lassonde Program in Mining Engineering,  
University of Toronto.

# **EXHIBIT C**

# Preliminary Economic Assessment Pickett Mountain Project

**Penobscot County, Maine, USA**

**68.468°W Longitude and 46.134°N Latitude**

**Effective Date: September 14, 2020**

**Filing Date: October 29, 2020**

**Prepared For**



**By**

**A-Z Mining Professionals Limited**

## TABLE OF CONTENTS

1.0	Executive Summary .....	1
1.1	Resources and Reserves .....	1
1.2	Project Operating Plan .....	2
1.3	Mine Plan.....	2
1.4	Processing.....	3
1.5	Infrastructure .....	3
1.6	Capital Expenditures.....	3
1.7	Operating Costs .....	4
1.8	Economic Analysis .....	4
1.9	Sensitivity Analysis .....	5
1.10	Conclusions.....	6
1.11	Recommendations .....	9
2.0	Introduction.....	10
2.1	Terms of Reference .....	10
2.2	Sources of Information.....	10
2.3	Site Visit.....	11
2.4	Units and Currency .....	11
2.5	Glossary and Abbreviations of Terms.....	12
3.0	Reliance on Other Experts .....	13
4.0	Property Description and Location.....	14
4.1	Land Tenure.....	14
4.2	Purchase Agreement .....	15
5.0	Accessibility, Climate, Local Resources, Infrastructure and Physiography .....	16
5.1	Accessibility .....	16
5.2	Climate.....	16
5.3	Local Resources .....	16
5.4	Infrastructure .....	16
5.5	Physiography .....	17
6.0	History of the Property.....	18
7.0	Geological Setting and Mineralisation .....	22
7.1	Regional Geology.....	22
7.2	Local Geology and Structure .....	24
7.2.1	Stratigraphy.....	26
7.2.1.1	Footwall Felsic Rocks .....	26
7.2.1.2	Massive Sulphide .....	27
7.2.1.3	Breccia Unit.....	27



7.2.1.4	Massive Mafic Flow.....	27
7.2.1.5	Mudstone and Siltstone.....	27
7.2.2	Metamorphism.....	27
7.2.3	Structure.....	27
7.3	Mineralisation .....	28
8.0	Deposit Type.....	33
9.0	Exploration .....	35
9.1	Airborne Geophysical Survey .....	35
9.2	Ground Infinitem XL Time Domain Electromagnetic Survey.....	36
9.3	Borehole Infinitem XL Time Domain Electromagnetic Survey .....	38
9.4	OreVision Induced Polarization Survey (IP).....	40
9.5	Wolfden 2019 Exploration.....	42
9.5.1	Borehole InfiniTEM XL Time Domain Electromagnetic Survey .....	43
9.5.2	Ground InfintiTEM XL Time Domain Electromagnetic Survey.....	44
9.5.3	Gravity Survey .....	45
9.5.4	Magnetics Survey .....	46
9.5.5	Whole Rock Geochemistry .....	47
9.5.6	Soil Geochemistry Compilation .....	48
10.0	Drilling .....	50
10.1	Historic Drilling .....	50
10.2	Wolfden Drilling.....	53
10.2.1	Wolfden Drilling 2019.....	55
11.0	Sample Preparation, Analyses, and Security .....	58
12.0	Data Verification.....	60
12.1	Historical Data Verification.....	60
12.2	Current Data Verification .....	62
12.2.1	Description of Control Charts.....	62
12.2.2	Quality Assurance/Quality Control (QA/QC) Evaluation .....	63
12.2.3	Comparison of Original and AGAT Check Sample Composites .....	68
13.0	Mineral Processing and Metallurgical Testing .....	70
13.1	Getty Mining Company, 1984.....	70
13.1.1	Sample Characterisation .....	70
13.1.2	Bond’s Ball Mill Work Index .....	70
13.1.3	Flotation Testing.....	70
13.1.3.1	Cu-Pb Bulk Flotation .....	71
13.1.3.2	Selective Cu, Pb, and Zn Flotation .....	72

13.1.4	Locked Cycle Flotation Tests .....	73
13.1.5	Miscellaneous Tests .....	75
13.2	Chevron Resources, 1988.....	76
13.3	Wolfden Resource Corporation, 2019.....	76
13.3.1	Sample Preparation and Characterisation .....	77
13.3.2	Bond’s Ball Mill Work Index .....	77
13.3.3	Rougher Flotation Testing .....	77
13.3.4	Cleaner Flotation Testing .....	80
13.3.5	Vacuum Filtration Test .....	82
13.3.6	Smelter Penalty Analyses .....	82
13.4	Conclusions.....	84
14.0	Mineral Resource Estimate .....	85
14.1	Introduction.....	85
14.2	Database.....	85
14.3	Data Verification.....	85
14.4	Domain Interpolation .....	86
14.5	Lens/Rock Code .....	88
14.6	Composites.....	88
14.7	Grade Capping.....	88
14.8	Variography .....	89
14.8.1	Discussion of Variograms .....	91
14.9	Bulk Density.....	91
14.10	Block Model.....	92
14.11	Resources Classification .....	92
14.12	Resources Estimate .....	94
14.13	Calculation of Cut-off .....	98
14.14	Confirmation of Estimate .....	100
14.15	Discussion of Results .....	100
14.15.1	Mineral Resources Used in the Mine Plan .....	106
15.0	Mineral Reserve Estimates .....	107
16.0	Mining Methods .....	108
16.1	General .....	108
16.1.1	Portal Excavation and Decline Drive .....	109
16.2	Underground Mine Design .....	110
16.3	Geotechnical Considerations.....	111

16.4	Mine Access and Level Development.....	111
16.4.1	Main Access.....	111
16.4.2	Level Access and Development.....	111
16.5	Rock Handling.....	112
16.6	Underground Services and Infrastructure.....	112
16.6.1	Electrical Distribution.....	112
16.6.1.1	Electrical Cabling.....	113
16.6.2	Compressed Air.....	113
16.6.3	Service Water.....	114
16.6.4	Mine Communications and Control Systems.....	114
16.6.5	Mine Dewatering.....	114
16.6.6	Breakdown Maintenance Shop.....	115
16.6.7	Fuel Stations.....	116
16.6.8	Refuge Stations.....	116
16.6.9	Explosives Storage.....	117
16.6.10	Detonator Magazine.....	118
16.6.11	Materials Storage Areas.....	118
16.6.12	Restrooms.....	118
16.6.13	Surface Support Facilities.....	118
16.7	Mining Methods.....	119
16.8	Dilution and Extraction.....	120
16.9	Mining Operations.....	121
16.9.1	Drilling.....	121
16.9.2	Blasting.....	121
16.9.3	Ground Support.....	121
16.9.4	Mucking.....	126
16.10	Mining Equipment.....	127
16.11	Mine Backfilling.....	128
16.11.1	Underground Distribution System.....	128
16.12	Ventilation.....	129
16.13	Development and Production Schedules.....	131
16.13.1	Productivities.....	131
16.13.2	Underground Mine Development Schedule.....	132
16.13.3	Mine Production Schedule.....	132
16.14	Mine Surface Infrastructure.....	133
16.14.1	Explosives Magazines.....	133
16.14.2	Other Facilities.....	133

16.15	Grade Control .....	134
16.16	Underground Personnel .....	135
17.0	Recovery Methods.....	137
17.1	Conceptual Process Flowsheet.....	137
17.2	Process Design Criteria .....	139
17.3	Reagents .....	139
17.4	Process Make-up Water .....	140
17.5	Material Balance (Product Production).....	140
18.0	Infrastructure .....	142
18.1	Existing Infrastructure .....	142
18.2	Access Road .....	142
18.3	Site Pad .....	142
	18.3.1 Main Pad Preparation .....	143
	18.3.2 Pad Construction .....	143
	18.3.2.1 Parking .....	143
18.4	Main Power to Site .....	144
	18.4.1 Power Distribution .....	144
18.5	Potable Water System .....	144
18.6	Sewage System .....	144
18.7	Buildings Earthworks .....	144
18.8	Quarry.....	144
18.9	Fuel and Fuel Storage .....	145
18.10	Propane .....	145
18.11	Change House (Dry Facility) .....	145
18.12	Materials Pads .....	145
	18.12.1 Rock Dump Construction (Clean) .....	145
	18.12.2 Rock Dump (Acid Generating) .....	145
	18.12.3 Ore Pad and Temporary Stockpile.....	146
18.13	Office Maintenance Complex.....	146
18.14	Surface Explosives Storage .....	146
18.15	Accommodations.....	146
18.16	Water Management System .....	146
18.17	Water Treatment Facility .....	146
18.18	Garbage .....	147
18.19	Standby Power Plant .....	147
18.20	Communications.....	147
18.21	Security.....	148

18.22	Tailings Management Facility .....	149
18.22.1	Operating Data .....	149
18.22.2	Design Criteria .....	150
18.22.3	TMF Conceptual Design.....	150
18.22.4	Base Grade and Containment System.....	151
18.22.5	Perimeter Berm and Ditch.....	152
18.22.6	Collection Pond .....	152
18.22.7	Closure.....	153
19.0	Market Studies and Contracts.....	154
19.1	Market Studies .....	154
19.2	Contracts .....	154
20.0	Environmental Studies, Permitting, and Potential Impacts .....	155
20.1	Regulatory Framework.....	155
20.1.1	Land Use Planning Commission (LUPC).....	155
20.1.2	Maine Department of Environmental Protection (MEDEP) .....	156
20.2	Mine Permitting Stages and Status .....	156
20.3	Environmental Studies and Impact Assessments.....	160
20.4	Social and Community Requirements .....	162
20.5	Mine Closure .....	164
21.0	Capital and Operating Costs .....	167
21.1	Capital Expenditures.....	167
21.1.1	Basis for Estimates .....	167
21.1.2	Direct Costs .....	167
21.1.3	Indirect Costs Estimate.....	168
21.1.4	Underground Mining.....	169
21.1.5	Processing Plant .....	172
21.1.6	Surface Infrastructure .....	174
21.1.7	Project Indirects and Owner's Costs .....	175
21.1.8	Total Capital Expenditures .....	175
21.1.9	Working Capital .....	176
21.1.10	Sustaining Capital .....	176
21.1.11	Financial Assurance Trust – Reclamation and Closure Costs .....	177
21.2	Operating Cost Estimates .....	177
21.2.1	Basis for Estimates .....	177
21.2.2	Mining.....	178
21.2.3	Water Treatment Facility .....	178
21.2.4	Processing Plant and Tailings Management.....	179



21.2.5	General and Administration (G&A) Costs.....	179
21.2.6	Concentrate Transport Charges .....	181
21.2.7	Project Total Operating Costs.....	181
21.2.8	Exclusions .....	182
22.0	Economic Analysis .....	183
22.1	Taxes.....	184
22.2	Financial Returns .....	185
22.3	Sensitivity Analysis .....	185
23.0	Adjacent Properties.....	188
24.0	Other Relevant Data .....	189
25.0	Interpretation and Conclusions.....	190
26.0	Recommendations.....	193
27.0	References.....	195

## LIST OF FIGURES

Figure 1.1	Narrow Vein Mining Using Alimak Raise Platforms .....	2
Figure 1.2	NPV at 8% Discount Sensitivity Analysis.....	6
Figure 1.3	IRR Sensitivity Analysis .....	6
Figure 4.1	Pickett Mountain Project Location Map .....	14
Figure 4.2	Pickett Mountain Property Map.....	15
Figure 5.1	Patten, ME Historical Weather Data .....	16
Figure 6.1	Historic Soil Sampling Over the Pickett Mountain Property – Cu .....	19
Figure 6.2	Historic Soil Sampling Over the Pickett Mountain Property – Pb.....	19
Figure 6.3	Historic Soil Sampling Over the Pickett Mountain Property – Zn .....	20
Figure 6.4	Compilation of Historical Geophysical Surveys .....	20
Figure 7.1	Lithotectonic Divisions of the Northern Appalachian Orogen .....	22
Figure 7.2	Generalised Geology of the Northern Appalachians.....	23
Figure 7.3	Stratigraphic Section for the Weeksboro-Lunksoos Lake Anticlinorium, North-Central Maine, Showing Ordovician Through Devonian Rocks.....	24
Figure 7.4	Geology Plan Map of the Pickett Mountain Deposit.....	25
Figure 7.5	Cross Section of the Pickett Mountain Deposit.....	25
Figure 7.6	Longitudinal Section of the W1, E1, and E2 Massive Sulphide Lenses.....	29
Figure 7.7	Longitudinal Section of the W2 Massive Sulphide Lens.....	29
Figure 8.1	Idealised VMS Deposit Showing a Strataform Lens of Massive Sulphide Overlying a Discordant Stringer Sulphide Zone within an Envelope of Altered Rock (Alteration Pipe).....	33
Figure 8.2	Schematic Illustrating the Relationship between Subvolcanic Intrusions, Subsea-Floor Alteration, Syn-Volcanic Faulting and the Generation of VMS Deposits .....	34
Figure 9.1	VTEM™ Airborne Geophysical Survey Coverage .....	35
Figure 9.2	Ground InfiniTEM Time-Domain EM Survey Coverage .....	37
Figure 9.3	Conductors Defined by the Ground InfiniTEM Time-Domain EM Survey .....	38
Figure 9.4	Holes Surveyed by InfiniTEM XL TDEM Survey.....	39
Figure 9.5	Conductive Plates Defined by the down-the-hole InfiniTEM XL TDEM Survey.....	40
Figure 9.6	Chargeability Anomalies Defined by the OreVision IP Survey .....	41
Figure 9.7	Resistivity Anomalies Defined by the OreVision IP Survey .....	42

Figure 9.8	Longitudinal Section Depicting Borehole InfiniTEM XL Time Domain EM Survey, Conductive Plates .....	44
Figure 9.9	Ground InfiniTEM XL Time Domain EM Survey, Conductors.....	45
Figure 9.10	Residual Gravity Anomaly Map .....	46
Figure 9.11	Total Field Magnetic Survey .....	47
Figure 9.12	Whole Rock Geochemistry (Na <sub>2</sub> O) in the locale of the East and West Lenses .....	48
Figure 9.13	(Zn+Pb+Cu) Compilation Map .....	49
Figure 10.1	Location of Historical and Wolfden Drill Holes .....	55
Figure 10.2	Location of All Drill Holes and Wolfden 2019 Drill Holes .....	56
Figure 12.1	Core Storage Facilities Maintained by Huber Engineered Woods at Their Plant Located in Easton, Maine at “Remote Warehouse 1” Where a Majority of the Core is Stored Piled on Shelving Units .....	60
Figure 12.2	Core Boxes with Mineralised Sections Located at the Core Storage Facility .....	60
Figure 12.3	The Casing Located in the Field and Identified as Being the Collar for Hole 66-46 .....	61
Figure 12.4	Zn QA/QC Control Charts .....	63
Figure 12.5	Pb QA/QC Control Charts .....	65
Figure 12.6	Cu QA/QC Control Charts .....	66
Figure 12.7	Ag QA/QC Control Charts .....	67
Figure 12.8	Au QA/QC Control Charts .....	68
Figure 13.1	Locked-cycle Test Flowsheet .....	75
Figure 13.2	Locked-cycle Test Flowsheet .....	75
Figure 14.1	Wireframes.....	87
Figure 14.2	Pre-2018 Diamond Drilling .....	87
Figure 14.3	2017/2018 Showing 2018 Diamond Drilling.....	88
Figure 14.4	3D Variogram of Metals Looking Down .....	89
Figure 14.5	3D Variogram of Metals Looking North .....	90
Figure 14.6	3D Variogram of Metals Looking West.....	90
Figure 14.7	Mineralisation, as Defined from Distance to Diamond Drill Hole .....	93
Figure 14.8	Area in Blue Shows Inferred Resource, Red Shows Indicated Resource; Both Categories Trimmed to 9% ZnEq .....	93
Figure 14.9	Flow Chart of Resource Classification .....	94
Figure 14.10	ZnEq Tonnage Curve Limited to Mineralised Lenses .....	95
Figure 14.11	ZnEq Histogram Limited to Mineralised Lenses .....	96
Figure 14.12	Indicated (Red) and Inferred (Blue) Domains Superimposed on the Entire Geological Model.....	97
Figure 14.13	Showing Location of Material > 7% ZnEq < 9% ZnEq .....	97
Figure 14.14	Grade Shells of Lenses – Footwall View Looking Southeast.....	105
Figure 14.15	Grade Shells of Lenses – Hanging Wall View Looking Northwest .....	105
Figure 16.1	Pickett Mountain Mine Design Longitudinal Section Looking North .....	108
Figure 16.2	Typical Ramp Cross Section .....	110
Figure 16.3	Typical Sump Arrangement .....	115
Figure 16.4	Fail Safe Fuel and Lubrication Systems .....	116
Figure 16.5	Standard Refuge Station.....	117
Figure 16.6	Section Through a Standard Explosives Storage Area .....	118
Figure 16.7	Section of a Typical Drift.....	123
Figure 16.8	Nominal Bolting and Screening Pattern .....	124
Figure 16.9	Plan of Cable Bolting Pattern in Intersections.....	125
Figure 16.10	Section Showing Cable Bolts in an Intersection .....	126
Figure 16.11	Borehole Hoist Showing Skip and Counterweight.....	127
Figure 16.12	Main Ventilation System Showing 150,000 CFM Down Ramp and 125,000 CFM Down the Borehole .....	129

Figure 17.1	Conceptual Process Flowsheet.....	138
Figure 18.1	Potential Road Access Upgrade.....	142
Figure 18.2	Potential Pad Design .....	143
Figure 18.3	Water Treatment Plant Block Diagram .....	147
Figure 18.4	Plan Showing General Arrangement of Surface Infrastructure.....	148
Figure 18.5	Plan Showing General Arrangement of Tailings Management Facility .....	151
Figure 20.1	LUPC Posted Following Petition Review Schedule .....	158
Figure 22.1	NPV at 8% Discount Sensitivity Analysis.....	186
Figure 22.2	IRR Sensitivity Analysis .....	187

## LIST OF TABLES

Table 1.1	Mineral Resource Statement – January 2019 with 9% ZnEq Cut-off .....	1
Table 1.2	Mineral Resource Statement – Updated September 2020 with 7% ZnEq Cut-off.....	1
Table 1.3	Capital Cost Estimate by Area .....	4
Table 1.4	Project Total Operating Costs .....	4
Table 1.5	Commodity Pricing .....	4
Table 1.6	Cashflow Model Input Parameters .....	5
Table 7.1	Significant Drill Intercepts from Historic Drilling and Wolfden Drilling (PM Series of Holes) .....	31
Table 10.1	Summary of Historic Diamond Drilling.....	51
Table 10.2	Summary of Wolfden Diamond Drilling .....	54
Table 10.3	Summary Table of Wolfden 2019 Drill Results .....	57
Table 12.1	Comparison of Check Sample Assays with Historical Record .....	61
Table 12.2	Original Versus Outside-Lab Check Composites .....	69
Table 13.1	Head Analyses of Composite Samples .....	70
Table 13.2	Metallurgical Results for Na <sub>2</sub> SO <sub>3</sub> – NaCN – Na <sub>2</sub> CO <sub>3</sub> Depressant System .....	71
Table 13.3	Metallurgical Results for Ca(OH) <sub>2</sub> – ZnSO <sub>4</sub> /NaCN – SO <sub>2</sub> Depressant System.....	71
Table 13.4	Results of Cu-Pb Bulk Flotation and Separation.....	72
Table 13.5	Preliminary Selective Copper Flotation Results .....	72
Table 13.6	Lead Flotation Results .....	73
Table 13.7	Locked-cycle Test Conditions .....	73
Table 13.8	Locked-cycle Test Results (Test 49).....	74
Table 13.9	Impurity Analyses of Concentrates .....	74
Table 13.10	Projected Metallurgical Results from Batch Tests using Different Flowsheets .....	76
Table 13.11	Head Analyses of Composite Samples Including ICP .....	77
Table 13.12	Differential Flotation Results .....	78
Table 13.13	Sequential Flotation Results.....	79
Table 13.14	Rougher Flotation Results - Concentrate Production .....	80
Table 13.15	Copper Cleaner Results .....	81
Table 13.16	Lead Cleaner Results .....	81
Table 13.17	Zinc Cleaner Results .....	81
Table 13.18	Vacuum Filtration Data of Rougher Flotation Tails.....	82
Table 13.19	Metal Analysis of Cleaned Concentrate Samples.....	83
Table 14.1	Mineral Resource Summary January 2019 with 9% ZnEq Cut-off.....	94
Table 14.2	Mineral Resource Statement – Updated September 2020 with 7% ZnEq Cut-off.....	95
Table 14.3	Sensitivity of Indicated Resource to Cut-off Grades – January 7, 2019 .....	95
Table 14.4	Sensitivity of Inferred Resource to Cut-off Grades – January 7, 2019 .....	95

Table 14.5	ZnEq Cut-offs Limited to Mineralised Lenses.....	96
Table 14.6	Mineral Resource Metal Prices .....	98
Table 14.7	Calculation of NSR/ZnEq Cut-off .....	98
Table 14.8	Indicated Resources .....	98
Table 14.9	Inferred Resources .....	99
Table 14.10	Showing Representative Recovered Value of Indicated Resource .....	99
Table 14.11	Showing Representative Recovered Value of Inferred Resource .....	99
Table 14.12	Metallurgical Recoveries (1984 by Getty at Lakefield) .....	100
Table 14.13	Historical 1983 Resource.....	101
Table 14.14	Mineral Resource Summary – January 7, 2019.....	101
Table 14.15	List of Significant Intersections Used to Calculate the Mineral Resource .....	102
Table 14.16	List of Diamond Drill Collars from 2018 Diamond Drilling .....	104
Table 14.17	Updated Mineral Resources used in Mine Plan.....	106
Table 16.1	Estimated Connected Load .....	113
Table 16.2	Water and Air Usage .....	114
Table 16.3	Mine Equipment Fleet.....	128
Table 16.4	Ventilation Requirements .....	131
Table 16.5	Life of Mine Lateral Development Schedule.....	132
Table 16.6	Life of Mine Vertical Development Schedule.....	132
Table 16.7	Life of Mine Production Schedule .....	133
Table 16.8	Underground Mine and Maintenance Manpower Complement.....	135
Table 17.1	Design Criteria for Plant Processing 1,300 mtpd .....	139
Table 17.2	Estimated Reagent Consumption per Tonne of Ore .....	140
Table 17.3	Concentrator Water Balance .....	140
Table 17.4	Material Balance for the Processing Plant .....	141
Table 19.1	Metal Price Deck .....	154
Table 20.1	Demographics of the Current Population and Employment Statistics .....	163
Table 20.2	Regional Public Schools.....	164
Table 21.1	Breakdown of Mine Capital Expenditures .....	170
Table 21.2	Mine Development Capital Expenditures Estimates.....	171
Table 21.3	Underground Mine Infrastructure Capital Expenditure Estimates.....	172
Table 21.4	Major Equipment List for Milling Circuit.....	173
Table 21.5	Plant Capital Cost .....	174
Table 21.6	Infrastructure and Support Services Capital Expenditures .....	175
Table 21.7	Project Pre-Production Capital Expenditures .....	176
Table 21.8	Project Sustaining Capital Requirements.....	177
Table 21.9	Mine Operating Costs.....	178
Table 21.10	Breakdown of Processing Costs .....	179
Table 21.11	General and Administrative Operating Cost Components .....	180
Table 21.12	G&A Manpower Costs.....	181
Table 21.13	Project Total Operating Costs .....	181
Table 22.1	Commodity Pricing.....	183
Table 22.2	Cashflow Model Input Parameters .....	183
Table 22.3	Expected Project Returns.....	185
Table 22.4	NPV 8% Discount Sensitivity Analysis .....	185
Table 22.5	Pre-tax IRR Sensitivity Analysis .....	186

STATE OF MAINE  
DEPARTMENT OF AGRICULTURE, CONSERVATION & FORESTRY  
LAND USE PLANNING COMMISSION

IN THE MATTER OF	)	Pre-Filed Direct Testimony of Ronald
REZONING PETITION ZP 779A	)	Little on Behalf of Wolfden Mt.
WOLFDEN MT. CHASE, LLC	)	Chase, LLC

On behalf of Wolfden Mt. Chase, LLC (“Wolfden”), Ron Little is submitting this pre-filed direct testimony in support of ZP 779A.

**I. QUALIFICATIONS AND EXPERIENCE**

I am a Professional Engineer of Ontario, Canada, and hold a Bachelor of Science degree in Engineering with Honors from Queen’s University (1985), Kingston, Ontario, Canada.

A. Work Experience

Since July 2018, I have served as the President and CEO of Wolfden Resources Corporation, which is discussed more in Section II below. I have over 35 years of senior level experience in the mining sector that includes mine exploration, project development and planning, mine operations/management (underground and open pit), mine financing, corporate development, and mergers and acquisitions. This experience has also included roles as an independent consulting engineer as a qualified person under Canadian National Instrument 43-101 for technical studies and reports for various exploration and development projects. I have mining experience in Canada, USA, South America and Africa.

The majority of my career was spent as the founder, President and CEO of Orezone Resources Inc. and Orezone Gold Corporation (1995-2017), which focused on the discovery and development of large-scale gold mining projects in Burkina Faso, West Africa. Orezone developed the Essakane gold mine has been producing approximately 400,000 ounces of gold per annum since 2010 and contributes significantly to the GDP of the country of 22 million



people. The mine was permitted in 2007 and a project debt facility of \$340 million was approved by a syndicate of lenders in 2008. In 2009, IAMGold purchased Orezone Resources Inc. to acquire the Essakane mine. Orezone Gold Corporation was spun-out as part of that transaction and then went on to develop the Bombore Gold Project from 2009 to 2022. Bombore commenced production in 2022 and mine is now producing over 140,000 ounces of gold per annum.

During my work with Orezone, I was also involved in public market equity financings (+\$300 million), project debt facility financings (\$350 million) and corporate transactions (+\$550 million). All of the mining operations were developed and constructed to meet local and international mining codes and world bank standards.

Additional prior work experience includes the following:

**1985-1991 Practicing Geological Engineer and Geologist, Golden Patricia Mine**

Located in Northern Ontario Canada. I was a senior member of the technical team that discovered, developed, constructed and operated a small footprint, underground gold mining operation that produced on average 80,000 ounces per annum. The mine was in a remote location and included the construction of a full-service camp, mine site, offices, tailings facility, both ramp and shaft access, a 40 mile winter access road, an airstrip and powerline. The mine operated as a fly-in, fly-out operation for personnel.

**1991 to 1995 Consulting Geological Engineer**

Developing mining and exploration projects in South America, the Caribbean, and Canada for various companies and engineering firms.

## B. The National Instrument 43-101

To understand the certifications and qualifications related to being a Professional Engineer in Canada and a qualified person under National Instrument 43-101, it may be helpful to provide some background on the Canadian regulations that were enacted to protect investors in the mining sector and that govern fraudulent or misleading statements. National Instrument 43-101 (“NI 43-101” or the “NI”) establishes standards for disclosing scientific or technical information on a mineral resource or mineral reserve.<sup>1</sup> Disclosures must be based upon information prepared by or under the supervision of a qualified person or approved by a qualified person. A qualified person:

- (a) is an engineer or geoscientist with a university degree, or equivalent accreditation, in an area of geoscience, or engineering, relating to mineral exploration or mining;
- (b) has at least five years of experience in mineral exploration, mine development or operation, or mineral project assessment, or any combination of these, that is relevant to his or her professional degree or area of practice;
- (c) has experience relevant to the subject matter of the mineral project and the technical report;
- (d) is in good standing with a professional association; and
- (e) in the case of a professional association in a foreign jurisdiction, has a membership designation that (i) requires attainment of a position of responsibility in their profession that requires the exercise of independent judgment; and (ii) requires A. a favourable confidential peer evaluation of the individual’s character, professional judgement, experience, and ethical fitness; or B. a recommendation for membership by at least two peers, and demonstrated prominence or expertise in the field of mineral exploration or mining.<sup>2</sup>

The qualified person must be a reputable professional who is knowledgeable of the mineral property concerned and who has sufficient experience and qualifications to make the

---

<sup>1</sup> The current National Instrument 43-101 can be accessed here: <https://www.bccsc.bc.ca/-/media/PWS/New-Resources/Securities-Law/Instruments-and-Policies/Policy-4/43101-NI-July-25-2023.pdf?dt=20230720163240>

<sup>2</sup> NI 43-101 at Part 1.1.

statements which are made within the report and public disclosure. There are also specific standards that govern technical reports, including their content, who may prepare them and their independence, reliance on other experts, identification of key assumptions, display of information, requirements related to forward-looking information, and other provisions to ensure that disclosures are accurate, made by qualified persons, and are not misleading to potential investors.

It is hard to overstate the importance to the mining industry of the National Instrument and the scientific and technical requirements it imposes and standards it establishes. It establishes a solid, consistent, and verifiable foundation for communicating information on mine exploration, development and operations. Although the US has adopted a similar reporting standards to NI, known as S-K 1300, it does not require Qualified Persons to be independent of the registrant and permits third party firms to “single sign-off” and assume liability for a Technical Report Summary such as a mineral resources estimate statement.

## **II. WOLF DEN RESOURCES CORPORATION**

Wolfden Resources Corporation (“Wolfden”) is a Canadian exploration and development company with a management team that has a proven track record of precious and polymetallic deposit discoveries along with mine development and mine finance experience. Wolfden is the sole owner of Wolfden Mt. Chase, LLC, which is the entity developing the Pickett Mountain Project. Key investors in Wolfden include Altius Minerals, Kinross and Equinox Partners LLC. Altius is a Canadian mineral royalty, renewable energy royalty and mineral resource project generator company with a market capitalization of approximately \$1B. Kinross is a major international gold producer with a market capitalization of approximately \$8.3B. Equinox

Partners LP is an investment firm that specializes in emerging markets and precious metals mining amongst other sectors.

Wolfden's flagship asset is the Pickett Mountain project, which represents one of the highest grade undeveloped polymetallic deposits in North America. Approximately 65% of the metals value contained in the Pickett Mountain deposit are deemed "Critical Minerals and Materials" by the U.S. Department of Energy (DOE).<sup>3</sup> Wolfden's portfolio also includes assets located in in Manitoba and New Brunswick, Canada that also focus on Copper, Zinc, Nickel and Cobalt.

Wolfden is referred to as a junior mining exploration and development company in the mining industry. The junior mining sector represents to the average investor as the higher risk, higher reward, investment portion of the mining sector. The junior companies feed the growth profile of the larger metal producers by tackling the higher risk projects. The risks are often related to political, social and economic issues as opposed to technical issues. The risks associated with the Pickett Mountain project are related primarily to regulatory uncertainty. Maine has enacted the most stringent mining regulations in North America and there is no track record of the Maine regulators applying these regulations or issuing previous mining permits in over three decades - the Pickett Mountain project is the first project proposed under the new 2017 regulatory program. As a result, Wolfden is trading a significant discount due to investor uncertainty over the new regulatory approval process. Until key milestones are achieved, such as a rezoning approval and approval of a mining permit under the Chapter 200 process, the value of the company will remain highly discounted. Once the Project is permitted, the market

---

<sup>3</sup> Department of Energy, What are Critical Materials and Critical Minerals, <https://www.energy.gov/cmm/what-are-critical-materials-and-critical-minerals> (last visited Sept. 18, 2023).

capitalization will adjust upward toward a value that is reflective of a discounted value of the net present value of the project as stated in independent economic study (feasibility study).

Although Wolfden is trading at a discount, which is typical at this stage of development, we have been very successful in raising the capital necessary to support the development of the Project to date. Since 2017, we have raised in excess of \$19M in financings and \$5M in timber sales, which has been used to fund the development of the Project. The fact that we are able to raise funds without a significant revenue stream is a testament to the value and experience of our management team, our track record of success, long-term shareholder support, and the strong economics of the Project.

### III. THE PICKETT MOUNTAIN PROJECT

Wolfden began studying the Pickett deposit in late 2017. There has been more than 165,000 feet of drilling in 204 holes, with over 7,000 core samples, yielding 179 drill intersections of mineralization, all of which was used to delineate the deposit and to estimate the 2021 mineral resource statement set forth below.

NOVEMBER 17, 2021 - MINERAL RESOURCE STATEMENT								
Category	Tonnes	% Zn	% Pb	% Cu	g/t Ag	g/t Au	Density	% ZnEq
Indicated	2,724,000	8.91	3.83	1.22	97.2	0.8	3.84	17.72
Inferred	3,593,600	9.27	3.83	1.00	105.4	0.7	3.81	17.65

Resource calculated using US\$1.20/lb Zn, \$2.50/lb Cu, \$1.00/lb Pb, \$16.00/oz Ag, and \$1,200/oz/Au, at a 7% base case cutoff grade that equates to an approximate NSR cut-off of \$139/tonne at the same metal prices. An average recovery of 75% for all metals was assumed based on preliminary metallurgical testing.

Wolfden appreciates the extensive process Maine has gone through in developing its current mining rules. We are excited and proud to bring forward this opportunity for a state-of-the-art mine that will meet those standards and (i) be fully protective of the environment, (ii)



generate high-paying jobs and create local workforce opportunities, and (iii) generate a domestic supply of critical minerals and materials.

The metals at the Pickett Mountain deposit are used in a variety of applications, including cellphones, automobiles (including electric vehicles), electronics, low-carbon power generation, construction, and infrastructure. Zinc is the primary metal in the deposit and, in 2022, the Secretary of the Interior, acting through the Director of the U.S. Geological Survey, added zinc to the list of critical minerals.<sup>4</sup> The critical minerals list includes “non-fuel mineral or mineral material essential to the economic and national security of the United States security.”<sup>5</sup> Zinc is also considered one of several critical minerals that is essential for the clean energy transition.<sup>6</sup> Copper, which was also added the critical minerals list this past year, is used in buildings, electrical distribution, electronic parts, plumbing and transportation. Lead is also used in transportation, batteries, and electrical equipment. It is estimated that, on average, each person in the U.S. uses twelve pounds of copper, eleven pounds of lead and six pounds of zinc annually.<sup>7</sup>

In short, the primary metals proposed for removal from the Pickett Mountain deposit are essential to modern life. The United States is dependant on these critical minerals, but relies heavily on imports of these critical minerals from other nations.<sup>8</sup> It is anticipated that the demand will continue to surge over the next twenty years, and analysis of the U.S. supply chain

---

<sup>4</sup> 87 Fed. Reg. 10381 (February 24, 2022).

<sup>5</sup> Nedal T. Nassar, et al., *Evaluating the Mineral Commodity Supply Risk of the U.S. Manufacturing Sector*, Sci. Adv., 6(8) (2020), <https://www.science.org/doi/10.1126/sciadv.aay8647>; see 87 Fed. Reg. 10381 (citing Nassar et al.).

<sup>6</sup> See International Energy Agency, *The Role of Critical Minerals in Clean Energy Transition* (Rev. Mar. 2022), <https://iea.blob.core.windows.net/assets/ffd2a83b-8c30-4e9d-980a-52b6d9a86fdc/TheRoleofCriticalMineralsinCleanEnergyTransitions.pdf>.

<sup>7</sup> United States Geological Survey, *How many pounds of minerals are required by the average person in a year?*, <https://www.usgs.gov/faqs/how-many-pounds-minerals-are-required-average-person-a-year> (last visited Sept. 13, 2023)

<sup>8</sup> United States Geological Survey, *Mineral Commodity Summaries 2021* at 7, <https://pubs.usgs.gov/periodicals/mcs2021/mcs2021.pdf> (in 2020, the U.S. imported 83% of its refined zinc, 37% of its refined copper, and 24% of its refined lead).

recommends investment in environmentally sustainable and responsible critical mineral extraction and processing facilities in the United States.<sup>9</sup> While some recycling occurs, it does not meet demand. Unless we are prepared to live without them, critical minerals should be mined in an environmentally sustainable and equitable manner, which is what we are proposing to do.

Importantly, the value of the mineral deposit can support the higher costs associated with meeting Maine's stringent regulatory requirements. Specifically, the PEA indicates that a discounted after-tax value of the project is \$198 million with an after-tax internal rate of return (IRR) of 37%. Mining projects in the last decade usually require an IRR of over 25% using at least a discounted rate of 5% in areas with good infrastructure and up to 10% in more remote areas. The Pickett Project meets the criteria of a robust project with good infrastructure. In addition, the high potential profit margins support the increased costs of meeting more stringent environmental standards. For this reason, the Pickett Project represents a new higher standard as a show case for modern mining for the rest of the world to try to emulate.

#### **IV. PROJECT FINANCING**

The financing required to construct and operate a mine really does not commence until a permit for the project is at least conditionally received. Delays in receiving permits has become more normal in the last decade and therefore investors and bankers do not typically finance projects until permits have been issued. Mine permitting world-wide is typically a two-to-five-year process depending on the jurisdiction. If LUPC grants the rezoning, we are anticipating a minimum of three additional years to complete the DEP permitting process.

---

<sup>9</sup> The White House, *Building Resilient Supply Chains, Revitalizing American Manufacturing, and Fostering Broad-Based Growth: 100-Day Reviews Under Executive Order 14017* at 9, 14-15 (June 2021), <https://www.whitehouse.gov/wp-content/uploads/2021/06/100-day-supply-chain-review-report.pdf>.

The minimum/basic economic parameters to finance a mine via a combination of 40% debt and 60% equity, are an after-tax IRR of over 20% using a reasonable discount rate of 5% or higher. This Project readily meets these financing criteria based on an 8% discount rate and an IRR of 37%. Importantly, these criteria are based on the PEA, which represents an independent evaluation of the Project economics prepared by Qualified Persons in accordance with NI43-101 that was enacted to protect investors from fraudulent statements in the mining sector (see above).

Alternatives that can allow the project to be financed in challenging market conditions include a merger or acquisition of Wofliden by a larger company to form a stronger balance sheet. This will not affect the local outcome or operations of the Project if it is near or already permitted and or under construction. To uphold the permit, the same conditions apply to the new entity and must continue, including meeting all standards and following the same operating parameters as required by the DEP mining permit. The closure and reclamation trust fund that is placed in the hands of the DEP (upfront) will remain unchanged and will always remain regardless of any ownership changes. In most cases, under any corporate transaction merger, the operating management team on the ground remains unchanged due to their knowledge of the project and experience in the region.

On behalf of Wofliden and its stakeholders, we would like to thank the Commission and its Staff for their time spent in considering this proposal. We look forward to presenting our proposal at the hearing and providing further information in response to questions.

Dated: September 19, 2023



\_\_\_\_\_  
Ronald Little

Province of Ontario

Date: September 19, 2023

Personally appeared before me the above-named Ronald Little, who, being duly sworn, did testify that the foregoing testimony was true and correct to the best of his knowledge and belief.

Before me,



\_\_\_\_\_  
Notary Public

My commission expires: \_\_\_\_\_

Salvatore Federico Barbieri

STATE OF MAINE  
DEPARTMENT OF AGRICULTURE, CONSERVATION & FORESTRY  
LAND USE PLANNING COMMISSION

IN THE MATTER OF	)	Pre-Filed Direct Testimony of Sean
REZONING PETITION ZP 779A	)	Fieler on Behalf of Wolfden Mt.
WOLFDEN MT. CHASE, LLC	)	Chase, LLC

On behalf of Wolfden Mt. Chase, LLC (“Wolfden”), Sean Fieler is submitting this pre-filed direct testimony in support of ZP 779A.

**I. QUALIFICATIONS AND EXPERIENCE**

I serve as President and Chief Investment Officer of Equinox Partners Investment Management, LLC, an investment firm based in Stamford, CT with a long-term commitment to the metals and mining sector. The firm manages ~\$650 million USD, ~\$310 million USD of which is invested in metals and mining. For more than 25 years we have tracked and evaluated ~1100 mining companies, across an array of jurisdictions.

**II. INVESTMENT IN THE PICKET MOUNTAIN PROJECT**

I first conducted business with Ron Little in connection with his work at Orezone in West Africa. Equinox Partners was a significant investor in Orezone, a company that Ron founded in the late 1990s and that developed two highly successful mines. Equinox, remains an investor in Orezone, to this day.

As long-term investors, we view our investments as partnerships with the management and directors of the companies in which we invest. Accordingly, we seek out companies with managements and boards that are not only technically talented, but develop responsibly, are trustworthy and forthright, and have a demonstrated track record of success. Equinox owns over 19% of Wolfden and that investment reflects our view that the Project and its management team are strong. We made our initial investment in the fall 2021. While the permitting timeline was



uncertain, we felt confident that the local support and technical merits of the project would translate into a sound long-term investment.

To be successful, junior companies must have the patience and tenacity to carry a project through the development and permitting phases. This patience is critical, as larger companies and large pools of capital invariably wait until a project is de-risked and permitted before making a more significant investment. The additional support from investors Kinross and Altius also reflects the strength of the Project and its management team.

### **III. FINANCING OF MINING PROJECTS GENERALLY AND THE PICKETT MOUNTAIN PROJECT SPECIFICALLY**

Wolfden is a junior mining company with a modest balance sheet and accrued cash losses as a result of the company's efforts to advance its project to production without revenues. The Pickett Project is the company's flagship asset. That said, there is also potentially significant value in the company's nickel assets in Manitoba and properties in New Brunswick. Like most pre-production junior mining companies, we believe Wolfden is currently trading at a significant discount. Once key regulatory milestones are met, we believe that the company will begin to re-rate upwards towards its intrinsic value.

I presume this project would be financed by a combination of debt, equity and royalty agreements. The precise combination of the various forms of capital will depend on market conditions. That said, I believe highly economic projects, that are technically straight forward and offer short payback periods, such as Picket Mountain, are particularly attractive to investors. Even in a weak market, good projects can attract capital.

As a New Englander myself, I understand and concur that all development in our region must meet the highest environmental standards. I believe The Pickett Project can both meet that high bar and provide an excellent return for investors.

Dated: September 21, 2023

*Sean Fieler*  
Sean Fieler

STATE OF New York  
County of Bronx

Date: 9/21/23

Personally appeared before me the above named Sean Fieler, who, being duly sworn, did testify that the foregoing testimony was true and correct to the best of his knowledge and belief.

Before me,

*Denise Alejo*

Notary Public

My commission expires: May 15, 2026

DENISE ALEJO  
NOTARY PUBLIC, STATE OF NEW YORK  
Registration No. 01AL6146290  
Qualified in Bronx County  
Commission Expires May 15, 2026

STATE OF MAINE  
DEPARTMENT OF AGRICULTURE, CONSERVATION & FORESTRY  
LAND USE PLANNING COMMISSION

IN THE MATTER OF )  
REZONING PETITION ZP 779A ) PRE-FILED DIRECT TESTIMONY  
WOLFDEN MT. CHASE, LLC ) OF WOLFDEN MOUNT CHASE, LLC

VOLUME IV OF IV  
(Testimony of Michael LeVert and Terry Thurston-Hill)

## **INDEX OF WITNESSES AND EXHIBITS**

### **VOLUME I**

#### **JEREMY OUELLETTE**

Pre-Filed Direct Testimony

- Exhibit A Chapter 200 Summary
- Exhibit B Statements from CLF and NRCM on Maine’s mining law
- Exhibit C Figure 2-1 conceptual site plan
- Exhibit D LUPC Guidance for Interpreting 2010 CLUP, October 5, 2012
- Exhibit E Summary of Wolfden Community Engagement
- Exhibit F Town of Hersey Mining Ordinance and Special Town Minutes from October 6, 2022
- Exhibit G Town of Patten – Special Town Meeting Minutes, April 13, 2023
- Exhibit H Town of Sherman – Resolution in Support of Wolfden Resources, April 4, 2023
- Exhibit I Town of Stacyville – Resolution in Support of Wolfden Resources, January 18, 2023
- Exhibit J Moro Plantation – Special Town Meeting Minutes, December 14, 2022
- Exhibit K Passamaquoddy THPO Comments to LUPC
- Exhibit L Maine Geological Survey Comments to LUPC

#### **DOUGLAS STEWART**

Pre-Filed Direct Testimony

- Exhibit A Curriculum Vitae
- Exhibit B Wolfden Regional Location Map
- Exhibit C Penobscot River Watershed Map
- Exhibit D Correspondence with MDIFW, September 25, 2023

#### **GEMMA-JAYNE HUDGELL**

Pre-Filed Direct Testimony

- Exhibit A Curriculum Vitae
- Exhibit B Northeast Archaeological Research Center Archaeological Phase 0 Assessment

### **VOLUME II**

#### **MARK PETERS**

Pre-Filed Direct Testimony

- Exhibit A Curriculum Vitae
- Exhibit B Wood (now WSP) Technical Memorandum

#### **BRIAN DANYLIW & PAUL THOEN**

Pre-Filed Direct Testimony

- Exhibit A Curriculum Vitae Danyliw

Exhibit B Curriculum Vitae Thoen  
Exhibit C Mine Water Service Water Treatment Report

**LISA TURNER**

Pre-Filed Direct Testimony

Exhibit A Curriculum Vitae  
Exhibit B Sevee & Maher Engineers Technical Memorandum, December 19, 2022  
Exhibit C Sevee & Maher Engineers Response to LUPC Comments, April 12, 2023  
Exhibit D Spray Irrigation Systems and Equipment  
Exhibit E Snowmaking Systems and Equipment

**JIM FINLEY**

Pre-Filed Direct Testimony

Exhibit A Curriculum Vitae

**DON DUDEK**

Pre-Filed Direct Testimony

**VOLUME III**

**RONALD LITTLE**

Pre-Filed Direct Testimony

**BRIAN LeBLANC**

Pre-Filed Direct Testimony

Exhibit A Curriculum Vitae  
Exhibit B Overview of AMPL  
Exhibit C Preliminary Economic Assessment Cover Page and Table of Contents

**SEAN FIELER**

Pre-Filed Direct Testimony

**VOLUME IV**

**MICHAEL LeVERT**

Pre-Filed Direct Testimony

Exhibit A Curriculum Vitae  
Exhibit B Economic Assessment of the Proposed Project, November, 2022



**TERRY THURSTON-HILL**

Pre-Filed Direct Testimony

STATE OF MAINE  
DEPARTMENT OF AGRICULTURE, CONSERVATION & FORESTRY  
LAND USE PLANNING COMMISSION

IN THE MATTER OF	)	Pre-Filed Direct Testimony of Michael
REZONING PETITION ZP 779A	)	LeVert on Behalf of Wolfden Mt.
WOLFDEN MT. CHASE, LLC	)	Chase, LLC

On behalf of Wolfden Mt. Chase, LLC (“Wolfden”), Michael LeVert is submitting this pre-filed direct testimony in regard to ZP 779A.

**I. QUALIFICATIONS AND EXPERIENCE**

My name is Michael LeVert. I currently serve as the principal at Stepwise Data Research, an economic research firm based in Yarmouth, Maine. I have 20 years of experience providing quantitative and qualitative economic research and data analysis to Maine businesses, government, philanthropy, and non-profit organizations across a broad spectrum of industries and sectors. I served as Maine State Economist in Governor John Baldacci’s administration, and as Chief of Staff and Policy Director for the Maine State Senate President where I advised on issues related to workforce and economic development. I also worked as an economist for Delhaize America, as a statistician for L.L. Bean, as an econometrician for a healthcare analytics firm, and as the Chief Strategy Officer for Jobs for Maine’s Graduates where I led their research and strategy development. I have been a member of Maine’s Revenue Forecasting Committee, have twice been appointed to the state’s Consensus Economic Forecasting Commission, and I currently sit on the Advisory Board for the New England Public Policy Center at the Federal Reserve Bank of Boston. I also taught a graduate level economics course for four years as an adjunct professor at the University of Southern Maine’s Muskie School of Public Service.

My resume is attached as Exhibit A.

## **II. INVOLVEMENT WITH THE PICKETT MOUNTAIN PROJECT**

In 2021 I was asked by Wolfden to provide a comprehensive socioeconomic analysis of the effects of their Pickett Mountain Project on the region's economy. While an investment of the magnitude that Wolfden expects will clearly increase the economic activity in the region, my analysis aims to deepen our understanding of this new economic activity by quantifying the impact in terms of output, earnings, and jobs and contextualizing it within the region's current socioeconomic conditions. This testimony summarizes the analysis, including the methodology I used to conduct the analysis and the estimated impacts on the regional economy. My full analysis is included in the report submitted with the application, and is attached hereto as Exhibit B.

## **III. METHODOLOGY**

There are two distinct but related parts of my analysis. The first part is a descriptive analysis of the current socioeconomic conditions in the Pickett Project region. For this analysis, I primarily relied on the U.S. Census Bureau's American Community Survey five-year data for 2016-2020, the most reliable source of detailed information for communities with populations less than 65,000 and the most recent data at the time of my analysis. Using Census data and other publicly-available sources when appropriate, I compiled and analyzed socioeconomic data for Aroostook and Penobscot counties, the two counties with labor markets most likely to be impacted by the Project, and when possible, for the Houlton and Millinocket labor markets.<sup>1</sup>

The second part of my analysis is an estimate of the economic impact to the regional economy related to the Pickett Mountain project. For this analysis, I followed the standard procedure for conducting economic impact analyses of this type. I used the Regional Input-Output Modeling System (RIMS II) that the U.S. Bureau of Economic Analysis developed and

---

<sup>1</sup> As defined by the Maine Department of Labor.

maintains. The RIMS II model is a frequently used, well-regarded economic model that quantifies the inter-industry spending relationships between firms as well as the household spending patterns within a regional economy. RIMS II provides economic multipliers for 406 detailed industries and 62 aggregate industries.<sup>2</sup> These multipliers help estimate the total change in economic activity across all industries in the region resulting from an initial change in economic activity from Wolfden's spending on the Pickett Project. This total economic change, or impact, can then be classified in terms of business output (sales), jobs, and earnings within the region.

The smallest geography that the RIMS II economic model supports is a single county. Given this limitation – which to my knowledge is present in all other reputable economic impact models – and other characteristics of the Project related to labor markets, supply chains, and transportation routes, the appropriate economic region for the economic impact analysis is the combined two-county economic region of Aroostook and Penobscot counties, which encompasses the two labor markets most likely to be impacted by the Project. I requested and purchased a custom economic model of this two-county region from RIMS II which I used for my analysis.

The inputs to the economic model came primarily from Wolfden's detailed budget projections for the proposed project. To use the appropriate industry-specific RIMS II multipliers, I mapped 150 separate budget lines to a specific Maine industry based on the type of spending. For each budget line, Wolfden also provided estimates for how much of the spending was projected to be spent within the economic region, either on locally-procured materials or locally-procured labor. I then excluded from the economic model all spending that was expected

---

<sup>2</sup> As defined by the North American Industry Classification System (NAICS).

to be spent on firms or people outside of the economic region. (For example, I excluded from the model all spending on fabricated rebar because Wolfden estimates it will have to purchase this from companies outside of Maine.) This resulted in an exclusion from the economic impact analysis of roughly 45% of Wolfden's expected spending. Consistent with the RIMS II methodology, I also excluded spending on compensation related to benefits like retirement accounts which do not have an immediate economic impact.

In short, every attempt was made to estimate the economic impact in as rigorous, careful, and conservative a manner as possible. A more detailed explanation of the methodology can be found in Appendix G of the report, accessible at page 62 of Exhibit B. As affirmation of the methodology described above, the Land Use Planning Commission's hired economist stated in her response to my report, "[t]his type of economic impact analysis is widely used and is an appropriate choice" and, regarding my selection of the two-county economic region, "[g]iven the model that Stepwise Data Research used, the use of those counties as the reference area is justified, in our professional opinion."

#### **IV. ECONOMIC EFFECTS OF THE PICKETT MOUNTAIN PROJECT**

Clearly, injecting hundreds of millions of dollars into a regional economy will increase the economic activity in that region. My analysis aims to deepen our understanding of this new economic activity by quantifying the impact in terms of output, earnings, and jobs and contextualizing it within the region's current socioeconomic conditions.

##### **A. Socioeconomic Conditions of the Pickett Mountain Project Region**

The socioeconomic data for the region that surrounds the proposed Project area show a region that is a relatively sparsely populated with limited economic activity. The region is characterized by an aging population that has steadily decreased in size over time due in part to a



prolonged loss of manufacturing jobs and the out-migration of residents seeking employment elsewhere. Incomes in this region are also considerably lower than elsewhere in Maine, reflecting a lack of higher-paying jobs and the high prevalence of older residents who may no longer be in the workforce. Unemployment and poverty rates in the region currently exceed the state average and average wages in this region trail the state average by 20-30%. The data clearly indicate that this is an area in need of new economic opportunities and good-paying jobs.

### **B. Socioeconomic Impact of the Pickett Mountain Project**

The overall economic impacts of the Project are derived from Wolfden's direct spending to firms and people in the economic region, including for construction, infrastructure, building, and excavation services related to the project. Over the fourteen-year duration of the Project, Wolfden expects to spend \$622 million in non-contingency<sup>3</sup> spending. An estimated \$340 million will accrue directly to people and businesses in the economic region. Of this spending within the region, approximately \$54 million will take place during the startup phase and \$285 million will be spent once operations have commenced. *See* Table 16, accessible at page 21 of Exhibit B.

This direct spending will then multiply through the regional economy in the form of (1) indirect impacts, which come from the additional intermediate purchases that Wolfden's suppliers make, themselves, in order to support their provision of goods and services to Wolfden; and (2) induced impacts, which refer to the additional household spending by the employees of Wolfden and the firms that provide Wolfden goods and services. In total, Wolfden's direct spending results in an overall economic impact within the economic region of \$715 million in

---

<sup>3</sup> Wolfden has allocated \$25 million in contingency spending that has been set aside to cover potential costs that are not specifically accounted for in its financial model. The contingency spending is an important component of Wolfden's financial model. However, it has not been included in the socioeconomic impact analysis unless explicitly referenced.

business sales (output), \$248 million in total earnings, and 4,540 total job-years. *See* Table 20, accessible at page 24 of Exhibit B. The 4,540 projected job years translates to roughly 324 full- and part-time jobs each year for the 14 years of the project (although the actual level in a given year will vary) and are inclusive of the Project’s direct hires.<sup>4</sup> The total earnings in the region support roughly \$4.3 million in state sales tax revenues, \$4.3 million in local property tax revenues, and \$5.3 million in state income tax revenues. These tax estimates are based on the average tax incidence rate for all Maine households that the Maine Revenue Services periodically reports (their latest report at the time of my analysis was based on 2019 tax data). The tax revenue projections do not include any taxes that Wolfden, itself, will pay to local or state government.

The projected economic impacts described above also do not include any spending associated with the \$25 million that Wolfden has set aside as contingency spending. If contingency spending is used, and assuming it is spent in a similar way as the non-contingency spending, the projected economic impacts will increase by about 4%. *See* Table 25, accessible at page 28 of Exhibit B.

The projected economic impact described above depends significantly on Wolfden’s assumptions for the portion of Project spending that will be spent within the economic region. As mentioned previously, I excluded roughly 45% of Wolfden’s total project spending from the economic model because that spending is projected to be spent outside of the economic region. If Wolfden spends a higher portion within the region – for example, by procuring more labor or supplies locally – the economic impact will be greater; if regional spending is lower, the impact will also be lower. To give a sense for how this affects the economic impact estimates, a

---

<sup>4</sup> A “job-year” represents a single job, either full- or part-time, for a single year.

proportional 10% decrease in the expected level of spending within the region would result in 3,630 job years and a proportional 10% increase in the expected level of spending within the region would result in 5,450 job-years. *See* Table 28, accessible at page 29 of Exhibit B.

Embedded in the economic projections are also the wages that Wolfden expects to pay its employees working in the economic region. Wolfden projects to pay its employees, on average, \$64,000/year, which is roughly 130% of the current average annual wage in the economic region. *See* Table 18, accessible at page 22 of Exhibit B. I also qualitatively assessed the economic impacts of the Project on the regional tourism industry. Note that from an economic development perspective, a region's tourism industry represents only that spending associated with visitors from outside of the region (and preferably overnight visitors from outside of the state). In other words, local residents who recreate locally are not considered tourists and therefore my assessment of the project's economic impact on tourism only refers to its effect on tourism-related activities by visitors from outside of the economic region. Given that all of the region's major tourist attractions are located a considerable distance from the project (more than one hour away by car), that the Project's footprint will be less than one square mile, that – to my knowledge – the area to be rezoned does not have any snowmobile or ATV trails, and the region is not a “gateway-community” to Mount Katahdin, a reasonable conclusion is that the Project will have little to no adverse impact on the region's tourism industry.

In summary, based on the anticipated spending of more than half a billion dollars on the Pickett Mountain project – of which more than \$300 million will be spent directly on firms and people living in the economic region – the Pickett Mountain Project will result in a significant economic and fiscal contribution to the region which currently has limited economic opportunities.

**C. Economic Impact of the Mine-only**

The analysis described in my report and summarized above appropriately refer to the entire economic region and include the impact of all Project spending within the economic region. This is the correct methodological approach for economic impact studies like this and consistent with the direction provided by LUPC staff. However, in the interest of informing the Commission and other interested parties, I reconstructed the economic model with only the regional spending that relates to portions of the project in LUPC jurisdiction. The table below summarizes those results and is presented here not as a substitute for my analysis but to provide further information for the public hearing.

Of the \$340 million of total Project spending within the economic region, roughly 68% or \$232 million is related to the mine. *See* Table 16, accessible at page 21 of Exhibit B. Using the same methodology as described in part 1 above, the total projected output in the economic region related to mine-only spending is \$509 million or 71% of the total economic output from all Project spending. Total earnings in the region as a result of portions of the Project in LUPC jurisdiction are projected to be \$175 million, or 70% of total earnings from all Project spending. And the total number of job-years due to spending on the mine-only is projected at 3,140 or 69% of the total job-years from all Project spending. Similar to the impact of the total anticipated spending on the Pickett Mountain project, spending on only the portion of the project in the LUPC jurisdiction will also result in a significant economic and fiscal contribution to the region.

	Spending		Economic Impact		
	Total Project	Within Economic Region	Total Output	Total Earnings	Total Job-Years
<i>Total Project – Mine + Processing Facilities</i>	\$622,123,200	\$339,728,200	\$714,523,300	\$247,845,700	4,540
<b>Mine Only</b>	<b>\$400,822,700</b>	<b>\$232,384,500</b>	<b>\$509,075,200</b>	<b>\$174,555,100</b>	<b>3,140</b>
Percent of Total Project	64%	68%	71%	70%	69%

Dated: 9/14/23

  
Michael LeVert

STATE OF MAINE  
County of Cumberland

Date: 9/14/23

Personally appeared before me the above named Michael LeVert, who, being duly sworn, did testify that the foregoing testimony was true and correct to the best of his knowledge and belief.

Before me,

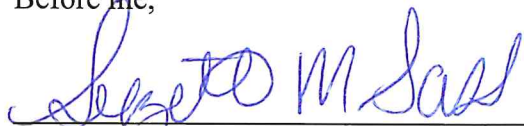
  
Notary Public  
My commission expires: 1-28-28

**SUZETTE M. SASS**  
Notary Public, State of Maine  
My Commission Expires Jan. 28, 2028



# **EXHIBIT A**

**MICHAEL J. LEVERT**  
P.O. Box 87  
Yarmouth, Maine 04096  
[michael@stepwiseresearch.com](mailto:michael@stepwiseresearch.com)

---

## PROFESSIONAL EXPERIENCE

---

<b>STEPWISE DATA RESEARCH</b> <i>Founder, Principal</i>	<b>Yarmouth, Maine</b> 2016-
<b>UNIVERSITY OF SOUTHERN MAINE</b> <i>Adjunct Faculty</i>	<b>Portland, Maine</b> 2018-2021
<b>JOBS FOR MAINE'S GRADUATES</b> <i>Chief Strategy Officer</i>	<b>Augusta, Maine</b> 2015-2016
<b>MAINE STATE SENATE</b> <i>Chief of Staff / Director of Policy (Office of the Senate President / Minority Office)</i>	<b>Augusta, Maine</b> 2013-2015
<b>DELHAIZE AMERICA/HANNAFORD</b> <i>Economist</i>	<b>Scarborough, Maine</b>  2011-2013
<b>MAINE STATE PLANNING OFFICE</b> <i>Maine State Economist / Economist</i>	<b>Augusta, Maine</b> 2007-2011
<b>HEALTH DIALOG INC.</b> <i>Senior Analyst</i>	<b>PORTLAND, MAINE</b> 2006-2007
<b>L.L BEAN INC.</b> <i>Statistician</i>	<b>FREEPORT, MAINE</b> 2003-2005

---

## EDUCATION

---

<b>MASTER'S DEGREE IN RESOURCE ECONOMICS</b> <i>University of Massachusetts, Amherst, MA</i>	<b>2007</b>
<b>GRADUATE CERTIFICATE IN STATISTICS</b> <i>University of Southern Maine, Portland, ME</i>	<b>2005</b>
<b>BACHELOR'S DEGREE IN MATHEMATICS AND STATISTICS</b> <i>University of Southern Maine, Portland, ME</i> <i>Clark University, Worcester, MA</i>	<b>2003</b>

---

## PROFESSIONAL AFFILIATIONS

---

Member, New England Public Policy Center Advisory Board at the Federal Reserve Bank of Boston (2020-present)  
Member, Maine Consensus Economic Forecasting Commission (2011-2012; 2017)  
Member, Maine Revenue Forecasting Commission (2009-2011)  
Leadership Committee, Mobilize Maine Greater Portland (2012)  
President, SAS Users Group of Maine (2006-2007)

## **EXHIBIT B**

# ECONOMIC ASSESSMENT OF THE PROPOSED PICKETT MINE PROJECT

Submitted to Wolfden Mt. Chase LLC

Stepwise Data Research  
November 2022

# Contents

- 1. Socioeconomic Conditions of the Pickett Mine Project Region..... 1
  - Key Findings ..... 1
  - Data Sources ..... 1
  - Defining the Region..... 2
  - Population..... 3
    - Density ..... 3
    - Population Growth..... 3
    - Age Structure ..... 4
    - Race and Ethnicity..... 5
    - Household and Family Structure..... 5
    - Household Income ..... 5
    - Poverty ..... 5
  - Labor Force ..... 6
    - Education ..... 6
    - Occupations ..... 7
    - Employment..... 8
    - Seasonality ..... 8
    - Commuting Patterns ..... 8
  - Industries ..... 9
    - Establishments..... 9
    - Employment..... 9
    - Retail Sales ..... 12
    - Tourism ..... 12
  - Housing ..... 14
    - Age of Housing Stock ..... 14
    - Occupancy..... 14
    - Housing Affordability ..... 15
  - Public Health ..... 15
    - Health Insurance ..... 15
    - Health Conditions and Risk Factors ..... 15



2. Economic Impact of the Proposed Pickett Mine Project on Regional Output, Earnings, and Jobs .....	17
Key Findings .....	17
Data Sources .....	17
Defining the Region.....	18
Wolfden Direct Expenditures.....	19
Capital Expenditures .....	19
Operating Expenses .....	19
Total Expenses .....	20
Expenses Within LUPC Region .....	20
Employment and Wages.....	21
Direct Spending by Industry.....	23
Indirect and Induced Economic Impacts.....	24
Economic Multipliers .....	24
Total Output, Earnings, and Job-Years.....	25
Output, Earnings, and Job-Years by Industry.....	26
Maine State Taxes.....	27
Economic and Fiscal Impact Including Contingency Spending .....	28
Caveats and Limitations .....	28
3. Other Economic Impacts (Qualitative Assessments) .....	30
Key Findings .....	30
Impact on the Tourism Industry .....	30
Impact on the Housing Market.....	31
Impact of Economic Incentives .....	32
Impact of Project-Sponsored Training Programs.....	32
Geographic Location of Businesses in Economic Area and Impact of Transportation .....	33
4. Appendices.....	34
Appendix A: Population .....	34
Appendix B: Labor Force .....	38
Appendix C: Industries .....	44
Appendix D: Housing.....	56
Appendix E: Public Health .....	59
Appendix F: Labor Market Area Map.....	61
Appendix G: RIMS II Multipliers .....	62

Appendix H: Economic Impact Methodology ..... 63

Appendix I: Budget Line Items to Industries, with Local Consumption Assumptions ..... 65

Appendix J: Estimate of Direct Costs by LUPC Jurisdiction ..... 71

Appendix K: Economic Impact by Phase ..... 72

Appendix L: Job-years by Project Phase..... 75

Appendix M: Comparison of cash-flow summary to economic input estimates..... 76

Appendix N: Map of Maine Tourism Regions ..... 78

Appendix O: Map of Businesses Along Transportation Routes ..... 79

# ECONOMIC ASSESSMENT OF THE PROPOSED PICKETT MINE PROJECT

In February 2021, Wolfden Mt. Chase LLC (Wolfden) retained Stepwise Data Research, an economic consulting firm based in Yarmouth, Maine, to provide a comprehensive socioeconomic analysis of Wolfden's proposed Pickett Mine Project (Project) proposed for T6 R6 in northern Penobscot County. This analysis is intended to meet the requirements of the Land Use Planning Commission (LUPC) specific to rezoning for Mining and Level C Mineral Exploration Activities in Chapter 12 of the LUPC Rules and as further informed by previous consultation with LUPC staff and LUPC's third-party economic expert. Section 1 of this report provides baseline statistics on the current socioeconomic conditions of the region surrounding the proposed Project. Section 2 quantifies the economic impact of the proposed Project in terms of jobs, earnings, and output. Because the Project's economic impact will be felt regionally, this section reports the economic impact for the entire Project, including both the mine located in T6 R6 and the concentrator and tailings facility which will be located in at a remote location. Section 3 provides a qualitative assessment of several other potential economic impacts related to the Project's operations. Section 4 is a detailed appendix including baseline economic statistics and a description of the methodology used for the economic impact analysis.

## 1. Socioeconomic Conditions of the Pickett Mine Project Region

### Key Findings

This section of the report presents information on the current socioeconomic conditions of the region surrounding the Project. The statistics reveal a sparsely populated region with limited economic activity and an aging population. Local wages trail the state average by 20-30% and poverty rates exceed the state average, particularly among children. In a place that once led Maine's manufacturing sector, the percentage of jobs in this field now trails the state average. The decline of the former Great Northern Paper mills in Millinocket and East Millinocket, which once employed thousands, has clearly hurt the local economy and no other large businesses have located here to take their place.

### Data Sources

Most of the statistics in this section of the report come from the U.S. Census Bureau's American Community Survey and are five-year estimates for 2016-2020. Results from the 2020 Census are utilized for demographic data. Except for the decennial census, five-year estimates are the most reliable source of detailed information on communities with populations under 65,000. Combining five years of survey results reduces the margins of error for statistics on small populations, while creating a more current snapshot of socioeconomic conditions than provided by the decennial censuses. Estimates for labor market areas (explained below) are aggregations of estimates for the municipalities and unorganized territories located within them. Where appropriate, these aggregations are weighted averages that account for the varying size and composition of the communities within each labor market area (LMA). See appendices for additional notes and data sources.

## Defining the Region

Wolfden’s proposed Project lies in a relatively remote, rural area on the border of northern Penobscot County and southwestern Aroostook County, Maine, in an unorganized township called T6 R6. The closest community is Mount Chase, a settlement with about 190 residents, located a few miles south. A few miles farther south along Rt. 11 is the town of Patten, with about 880 residents. Patten has been designated a “rural hub” by the LUPC, their designation for a community that provides services to nearby communities. The nearest larger communities are Houlton (6,050 residents), a 40-mile drive to the east, and Millinocket (4,100 residents), 50 miles south. These larger communities are the region’s principal employment centers and economic hubs and are classified as service centers by the State of Maine. The Project is roughly equidistant to both communities and will have an economic impact on both, through workforce and business connections. Therefore, the Houlton and Millinocket LMAs, as defined by the U.S. Department of Labor, are the principal geography for analysis in this section of the report (herein referred to as the “Pickett region”). Because the proposed Project’s supply chain of businesses will extend beyond the labor market into each of the two counties, this memo also presents statistics for Penobscot County, where the Project and most of Millinocket LMA are located; Aroostook County, which contains most of Houlton LMA; and the state of Maine.<sup>1</sup> Table 1 presents the towns and unorganized territories in Houlton LMA and Millinocket LMA.<sup>1</sup>

*Table 1: Towns in Houlton and Millinocket LMA*

<b>Houlton LMA</b>		<b>Millinocket LMA</b>
Amity	Macwahoc Plantation	East Millinocket
Bancroft	Merrill	Glenwood Plantation
Crystal	Monticello	Mattawamkeag
Danforth	Moro Plantation	Maxfield
Dyer Brook	Mount Chase	Medway
Hammond	New Limerick	Millinocket
Haynesville	Oakfield	Northeast Piscataquis UT*
Hersey	Orient	North Penobscot UT*
Hodgdon	Patten	Seboeis Plantation
Houlton	Reed Plantation	South Aroostook UT*
Island Falls	Sherman	Woodville
Kingman UT*	Smyrna	
Linneus	Stacyville	
Littleton	Weston	
Ludlow		<i>*UT = Unorganized Territory</i>

<sup>1</sup> Houlton LMA includes towns primarily in Aroostook and Penobscot counties, with one town in Washington County. Millinocket LMA also includes towns primarily in Aroostook and Penobscot counties, with one unorganized township in Piscataquis County. See Appendix for a map of labor market areas.

## Population<sup>ii</sup>

Approximately 27,000 people live in the Pickett region (consisting of the Houlton and Millinocket LMAs). They represent just 2% of Maine’s population and their numbers are declining. Since 1990, the region’s population has dwindled 19%, while the rest of Maine has grown 11.8%. Many young people have left in search of employment and the remaining population is notably older than the state average, especially in Millinocket LMA. Incomes are relatively low and poverty rates exceed the state average, especially among children.

### Density

The forestlands surrounding the Project are vast and sparsely populated (Table 2). The population density of Penobscot County (44.8 people per square mile) is similar to Maine overall (44.2), but the majority of residents are concentrated in Bangor, 100 miles south of the Project. The density of Houlton LMA, in which the Project is located, is two-thirds lower (16.6), and neighboring Millinocket LMA, which includes large swaths of unorganized territories, has just 2.7 people per square mile. Aroostook County’s density is 10.1.

Table 2: Population Density

	Maine	Aroostook County	Penobscot County	Houlton LMA	Millinocket LMA
Land area (square miles) <sup>2</sup>	30,845	6,671	3,397	1,086	3,378
People per square mile (2020)	44.2	10.1	44.8	16.6	2.7

### Population Growth

The population of the Pickett region has declined steadily since the 1970s and 1980s, mirroring changes in the forest products industry that once dominated the region (Chart 1). A series of mill layoffs and closures reduced employment opportunities, causing many residents to relocate. While some sites are being redeveloped, technological advances mean new operations do not require the thousands of workers mills once employed. Since 1990, Mount Chase’s population has dwindled by 26%, Patten’s by 30%, Millinocket LMA’s by 31%, and Houlton LMA’s by 10%. Today, 18,000 people live in Houlton LMA – 27% of Aroostook County’s population and 1.3% of Maine’s – and 9,100 people live in Millinocket LMA – 6% of Penobscot County’s population and less than 1% of the state.

---

<sup>ii</sup> See Appendix A for data sources and additional detail.



**Chart 1: Population Growth, 1970-2020**

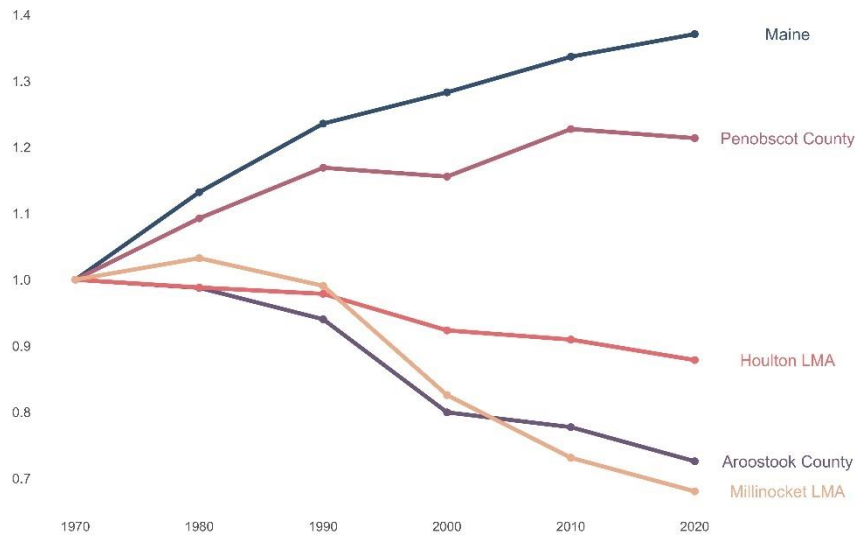

**Age Structure**

As the region’s population has declined, the age of its residents has risen, suggesting many emigrants were young people seeking opportunities outside the region. With a median age of 44.8 years, Maine is one of the oldest states in the nation, but Houlton LMA is older, with a median age of 46.3, and Millinocket LMA’s median is 54.3 years – nearly a decade above Maine’s.<sup>3</sup> Similarly, about 1 in 4 residents in these LMAs (22.9% and 28.0%, respectively) is age 65 or older, compared to 1 in 5 Maine residents (20.6%). Aroostook County’s median age (48.0 years) is slightly higher than the state’s, while Penobscot’s is notably lower (42.2 years), likely because of the numerous colleges in and around Bangor.

Chart 2 below presents the population distribution by generation. Compared to Maine, both LMAs have a higher percentage of older residents, and fewer children and young people, but Houlton LMA’s population is only slightly skewed while Millinocket LMA’s is significantly older.

**Chart 2: Age Distribution, 2016-2020**

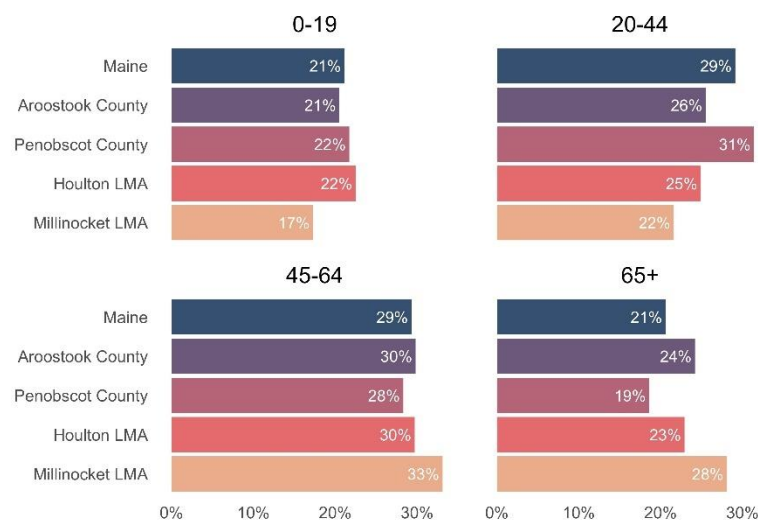

## Race and Ethnicity

The racial and ethnic mix of residents in the Pickett region largely mirrors Maine's overall population. More than 90% of Houlton LMA and Millinocket LMA residents identify as white (and not Hispanic or Latino), 1% are Hispanic or Latino, less than 2% are Black, Asian, or another race, and 2.9%-3.7% identify as two or more races. In Houlton LMA, over 3% of residents identify as Native American, which significantly exceeds the state rate of 0.5%. This is likely due to the Houlton Band of Maliseet Indians, which reportedly has about 1,700 members (although not necessarily living in Houlton LMA).<sup>4</sup>

## Household and Family Structure

The structure of households and families within the region reflects the age of its population, although there are subtle differences between Houlton LMA and Millinocket LMA. Despite Houlton LMA's population being slightly older than Maine's, its average household size (2.34 people) and average family size (2.93 people) are comparable to the state average (2.29 and 2.82, respectively).<sup>5</sup> By contrast, Millinocket's families and households are smaller (2.08 and 2.55, respectively). This paints a picture of Houlton LMA as a somewhat more vibrant population with more multi-generational households. For instance, in Houlton LMA, 1 in 3 married family households (33.6%) have at least one child living with them, compared to fewer than 1 in 4 married families in Millinocket LMA (24.6%), most likely because Millinocket's married couples are older.

## Household Income

Incomes in the Pickett region are significantly lower than elsewhere in Maine, most likely reflecting the region's lack of well-paying jobs and the age of its population. In 2016-2020, the median income of Houlton LMA households (\$43,740) was roughly comparable to Aroostook County's (\$43,791), while 26.5% below Maine's (\$59,489). Millinocket LMA's median household income was \$41,847 or 4.4% below Penobscot County's (\$52,128) and 29.7% below Maine's. More information about residents' wages is in the Industries section below.

## Poverty

In Houlton LMA, poverty across all age groups significantly exceeds the state average. In Millinocket LMA, poverty among those under age 65 exceeds the state average, but those age 65 and older are slightly less poor than their peers statewide. This may reflect the legacy of a previously robust forest products industry that provided well-paying jobs in decades past. The high percentage of older, non-poor residents in Millinocket LMA reduces its overall poverty rate. In 2016-2020, 18.1% of Houlton LMA residents were living in poverty, compared to 14.3% across all of Aroostook County. This could reflect Houlton's role as a regional service center. During the same period, 13.7% of Millinocket LMA residents were living in poverty, comparable to 13.4% throughout Penobscot County. However, poverty in all of these regions exceeds the state rate of 11.1%. Childhood poverty is particularly prevalent in the region. In both LMAs, approximately 1 in 3 children under age 5, or 28.8% in Houlton LMA and 34.8% in Millinocket LMA, is living in poverty. Maine's overall child poverty rate measures significantly lower from 2016-2020, at fewer than 1 in 6 Maine children (15.4%).

Comparing current poverty rates with a decade prior, from 2006-2010, shows subtle differences in the two LMAs (Chart 3). In both LMAs, poverty increased by between 1 and 2 percentage points. This contrasts to decreases statewide (-1.5%) and across both Penobscot (-2.3%) and Aroostook (-1.1%) Counties. In Millinocket, the increase appeared to be concentrated in children under 5, while in Houlton

LMA it was more evenly spread. (See Appendix A for more details; given the large margins of error for small towns in these LMAs, caution should be taken when interpreting these changes.)

Chart 3: Poverty Rate, 2016-2020

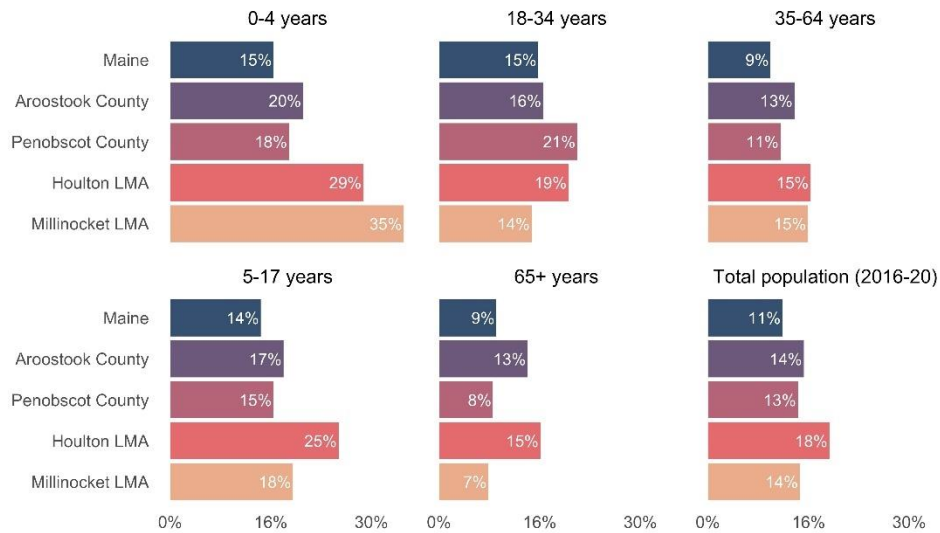

## Labor Force<sup>iii</sup>

In 2021, there were approximately 10,609 people in the labor force of the Pickett region (Houlton LMA and Millinocket LMA), equal to 1.6% of Maine’s entire labor force. Of these, on average, 9,909 were employed and 700 (6.6%) were unemployed. The region’s workers are notably older than the state average and have fewer college degrees. Nine in ten residents over age 25 have a high school diploma.

### Education

Roughly ninety percent of residents over age 25 in both Houlton and Millinocket LMA have a high school diploma, slightly below the statewide rate of 93.2% (Table 3). Compared to rest of Maine, formal measures of postsecondary educational attainment among workers in the Pickett region are relatively low. In 2016-2020, the percentage of Houlton LMA and Millinocket LMA residents with a bachelor’s degree or higher was half the state rate (17.2% and 12.7%, respectively, compared to 32.5% statewide). This likely reflects both the lack of demand for workers with postsecondary degrees and the historic dominance of industries that did not require them. Twenty percent of Aroostook residents have a bachelor’s degree or higher, as do 28.6% of Penobscot County residents. Penobscot trails the state in educational attainment despite the abundance of postsecondary institutions in and around Bangor, suggesting that many students leave the area after graduation.

<sup>iii</sup> See Appendix B for data sources and additional detail.

Table 3: Percentage of Population Over Age 25

	Maine	Aroostook County	Penobscot County	Houlton LMA	Millinocket LMA
<b>H.S. Diploma or Higher</b>	93.2%	89.8%	92.9%	89.1%	92.1%
<b>Associate’s Degree or Higher</b>	42.7%	31.7%	39.5%	27.3%	25.5%
<b>Bachelor’s Degree or Higher</b>	32.5%	19.8%	28.6%	17.2%	12.7%

### Occupations

The occupational mix of residents in the Pickett region reflects the area’s natural assets, sparse population, and lack of business activity (Table 4). Compared to Maine’s overall population, individuals are more likely to work in natural-resource-based industries of farming and forestry, and in the type of public service jobs required in all communities, such as healthcare support and protective services (firefighters, police, etc.). They are less likely to work in positions involving management, business, and financial services, and computers, engineering, and science. In terms of the occupations most relevant to mining – construction, installation, production, transportation, and material moving – in Aroostook and Penobscot Counties there are roughly 22,000 workers in these occupations today, and 2,800 workers within Houlton LMA and Millinocket LMA (see Appendix B for details).

Table 4: Ratio Local/State Occupation Percentage

	Aroostook County	Penobscot County	Houlton LMA	Millinocket LMA
1.00 means the local share of people in the occupation matches the state share. Values greater than 1.00 mean the local share exceeds the state share.				
<b>Management, business, and financial</b>	0.82	0.78	0.82	0.61
<b>Computer, engineering, and science</b>	0.42	0.82	0.32	0.30
<b>Education, legal, comm. svc., arts, and media</b>	0.83	1.05	0.87	0.79
<b>Healthcare practitioners and technical</b>	0.96	1.19	0.79	0.99
<b>Healthcare support</b>	1.28	1.22	1.31	1.43
<b>Protective service</b>	1.45	1.07	1.85	1.51
<b>Food preparation and serving related</b>	0.93	1.13	0.94	0.95
<b>Building and grounds cleaning and maintenance</b>	0.95	1.04	0.86	1.65
<b>Personal care and service</b>	0.93	1.16	0.85	1.09
<b>Sales and related</b>	0.94	1.14	1.20	0.97
<b>Office and administrative support</b>	1.10	1.01	0.88	1.13
<b>Farming, fishing, and forestry</b>	2.27	0.51	1.90	1.29
<b>Construction and extraction</b>	1.05	0.99	0.99	1.50
<b>Installation, maintenance, and repair</b>	1.24	1.19	1.33	1.63
<b>Production</b>	1.13	0.68	1.00	0.71
<b>Transportation</b>	1.49	1.08	1.78	0.91
<b>Material moving</b>	1.24	0.99	1.56	1.69

## Employment

Recent employment statistics suggest a labor market with limited employment opportunities (Table 5). In 2021, average employment was 6,876 in Houlton LMA and 3,033 in Millinocket LMA. Unemployment exceeded the state average (6.2% and 7.6%, respectively, compared to 4.6% statewide) and labor force participation rates suggest that unemployment could have been even higher if more residents had been actively seeking employment.

In 2016-2020, labor force participation was 63.0% statewide, but just 52.6% in Houlton LMA and 49.4% in Millinocket LMA. To be counted as participating in the labor force, an individual must be available to work and actively seeking employment. This means retirees, students, and those who are voluntarily caring for children or other family members at home are not considered to be in the labor force. The low labor force participation rates in the Pickett region partly reflects the advanced age of the population and a lack of job opportunities.

Table 5. 2021 Employment

	Maine	Aroostook County	Penobscot County	Houlton LMA	Millinocket LMA
<b>Labor force</b>	681,884	29,056	74,855	7,328	3,281
<b>Employment</b>	650,334	27,408	71,312	6,876	3,033
<b>Unemployment</b>	31,550	1,648	3,543	452	248
<b>Unemployment rate</b>	4.6%	5.7%	4.7%	6.2%	7.6%

## Seasonality

Employment opportunities in the Pickett region appear to model the seasonal fluctuations that typify Maine's economy. In 2021, employment was highest during the summer months, slightly lower in fall and winter, and lowest during spring "mud season". In 2021, the fluctuation between the highest-employment month, July, and the lowest, April, was 6.7% (451 jobs) in Houlton LMA and 9.3% (273 jobs) in Millinocket LMA. Statewide, employment fluctuated 2% between February and December 2021. Due to disruptions in the labor market in 2020 related to the coronavirus pandemic, throughout 2021 unemployment declined consistently in the state, county, and LMAs. This suggests that on top of seasonal fluctuation, the labor market was stabilizing throughout 2021 from significant changes during the prior year. Within the Pickett region, the fact that employment remains relatively high through the winter months compared to elsewhere in Maine likely reflects its popularity as a destination for snowmobiling and other winter recreation. As employment rises and falls, unemployment goes in the opposite direction.

## Commuting Patterns

Despite the region's vastness, most workers have shorter commutes than other Mainers. For instance, in Houlton LMA and Millinocket LMA, 33% of workers commute less than 10 minutes, compared to just 17% of all Maine workers. This may reflect both the availability of homes near workplaces and the ease of traveling on country roads. The exception to this trend is a small group of about 475 workers in Millinocket LMA (14% of its total workforce) who commute over one hour, compared to just 7% of Maine workers. These individuals may be traveling to jobs in Bangor or Houlton, both of which are just over one hour's drive.



## Industries<sup>iv</sup>

In 2021, the Pickett region had 868 business establishments with employees (about 1.5% of the state total). Collectively, they employed just over 7,800 workers (about 1.3% of the state total). This means that, on average, regional businesses are smaller than elsewhere in Maine. In 2021, the average number of jobs supported by Houlton LMA and Millinocket LMA employers was 9.5 and 8.0, respectively, compared to 10.2 statewide, 9.7 in Aroostook, and 12.5 in Penobscot. The mix of business establishments in the Pickett region reflects the area's unique connection to natural resources, for both recreation and extraction.

### Establishments

Compared to the rest of Maine, in 2021 the Pickett region had a higher concentration of businesses in the agriculture, forestry, fishing, and hunting industry classification; transportation and warehousing; and public administration. There was a lower concentration of businesses in wholesale trade and professional and technical services. Houlton LMA had a significantly higher percentage of health care and social assistance establishments (12.5% compared to 8.6% statewide), reflecting its role as a regional service center. Millinocket LMA had significant concentrations in retail trade; arts, entertainment, and recreation; and accommodation and food services, reflecting its proximity (about 25 miles) to Mount Katahdin and its role as a destination for outdoor recreation.

The overall number of business establishments in the region across all industries has declined in the past two decades, even while the number of Maine establishments has grown. From 2001 to 2021, the number of goods-producing establishments declined in Houlton LMA and Millinocket LMA by 17.3% and 20.4%, respectively (compared to a 12.2% increase statewide), while the number of service-providing establishments fell 11.7% and 18.5% (compared to a 32.1% increase statewide).

One hundred twenty-four businesses in Houlton LMA (20% of all local businesses) and 43 businesses (17%) in Millinocket LMA were in goods producing industries, which includes natural resource extraction, construction, and manufacturing.

### Employment

Mirroring the mix of business establishments, a disproportionate share of employment in the Pickett region is in retail trade, educational services, and health care and social assistance. In 2021, manufacturing held 8.5% and 5.3% of respective jobs in Houlton LMA and Millinocket LMA. The region trailed the state average of 9.9%, a striking fact in light of the past dominance of the region's forest products manufacturing sector. There was also a lower than average share of employment in wholesale trade, and professional and technical services. Houlton LMA had a significantly higher percentage of jobs in the agriculture, forestry, fishing, and hunting sector (4.7% compared to 1.4% statewide), which probably reflects the area's farming industry. Millinocket LMA has a higher percentage of employment in arts, entertainment, and recreation (6.0% compared to 1.6% statewide), which may reflect the presence of several outdoor recreation businesses, such as whitewater rafting companies.

Due to privacy laws, the exact numbers of workers employed by regional establishments is not available. The Maine Department of Labor only reports employment by wide ranges (e.g., 1-500). The largest employers in Aroostook County include health care providers such as Northern Light AR Gould Hospital

---

<sup>iv</sup> See Appendix C for data sources and additional detail.

and Northern Maine Medical Center, assisted living facilities and social service providers, major retailers such as Walmart and Hannaford, forest products manufacturers such as Louisiana Pacific, which is located within the Houlton LMA, and the Smith & Wesson gun manufacturer in Houlton. Most of Penobscot County’s largest employers are located in the Bangor metro area, with the exception of the Millinocket Regional Hospital.

Between 2001 and 2021, the percentage of jobs at goods-producing businesses fell from 19.7% to 16.9% across Maine (Chart 4). In Houlton LMA, it fell at an approximately similar rate, from 21.1% to 17.2% (a loss of 349 jobs). In Millinocket LMA, however, it plummeted from 34.1% to 10.3% (1,175 lost jobs). This reflects the historic dominance of the paper mills, which suffered closures and mass layoffs in the 2000s. For the industries most important to the Project’s supply chain (see economic impact analysis section), in Aroostook and Penobscot counties there are roughly 4,250 workers in the construction industry, 2,700 in wholesale trade, and 310 in utilities; for the two LMAs, there are 303 workers in construction, 113 in wholesale trade, and 77 in utilities. In all, in 2021 roughly 4,900 workers in Aroostook County, 6,800 in Penobscot County, 1,000 in Houlton LMA, and 200 in Millinocket LMA worked in goods-producing industries (see Appendix C for details).

*Chart 4: Goods Producing Industries*

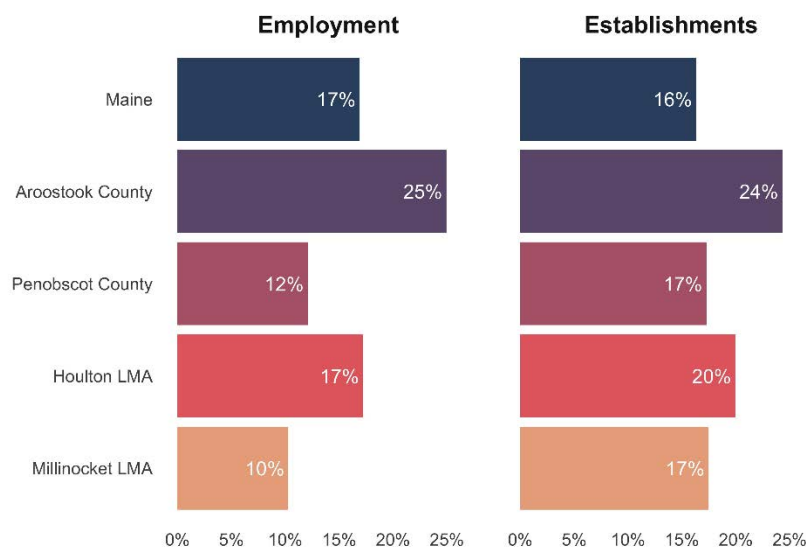

## WAGES

In 2021, average wages in the Pickett region were 25%-35% lower than elsewhere in Maine. The average weekly pay of a Maine job was \$1,051, compared to \$798 in Houlton LMA and \$720 in Millinocket LMA (Chart 5). Lower wages can reflect many things, including the local mix of industries and occupations, workforce skills, and the vibrancy of the local economy. In Houlton LMA, wages were nearer to the state average in public administration, utilities, construction, administration and waste services, and retail trade; they were 40% or more below the state average in finance and insurance; wholesale trade; real estate and rental and leasing; professional and technical services; and arts, entertainment, and recreation. In 2021, Houlton LMA's average weekly wage was fairly close to Aroostook County's (\$798 and \$836, respectively). In Millinocket LMA, wages were nearer to or above the state average in agriculture, fishing, forestry, and hunting; utilities; and arts, entertainment, and recreation; they were 50% or more below the state average in finance and insurance; and administrative and waste services. In 2021, Millinocket LMA's average weekly wage was well below Penobscot County's (\$720 compared to \$951).

Chart 5: Weekly Wages

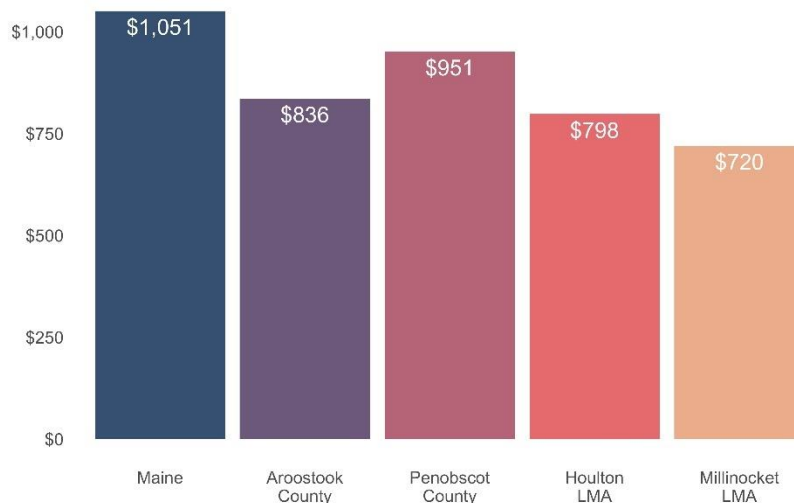

“Living wages” for Aroostook and Penobscot counties calculated by researchers at the Massachusetts Institute of Technology suggest local jobs may not pay enough to support a minimum standard of living. In 2020, the average weekly wage in these counties was \$836 and \$951, respectively. This would cover the needs of a single adult living alone (estimated at \$624-\$664 per week) but fall far short for an adult with one child (\$1,216-\$1,329 per week).<sup>6</sup> Table 6 below shows wages for other household compositions.

Table 6: Weekly Living Wage (2020)

	Maine	Aroostook County	Penobscot County
1 adult, 0 children	\$715	\$624	\$664
1 adult, 1 child	\$1,392	\$1,216	\$1,329
1 adult, 2 children	\$1,735	\$1,492	\$1,662
2 adults (both working), 0 children	\$478	\$458	\$464
2 adults (both working), 1 child	\$766	\$678	\$734
2 adults (both working), 2 children	\$991	\$869	\$955

## Retail Sales

In 2021, sales of taxable products in the Houlton, Millinocket, and Patten Economic Summary Areas (ESAs), were \$280 million, just 0.9% of the state total (Table 7).<sup>7</sup> This is a decline from 1.2% of statewide sales in 2010. On average, sales by businesses in these areas grew 38% from 2010 to 2021, well exceeding the rate of inflation during that time (24%). However, by contrast, sales by businesses across Maine rose 97%.

Table 7: Retail Sales (\$ thousands)<sup>8</sup>

	Maine	Houlton ESA <sup>9</sup>	Millinocket ESA <sup>10</sup>	Patten ESA <sup>11</sup>
Total taxable retail sales, 2021	\$32,474,400	\$180,696	\$60,864	\$38,219
Total taxable retail sales, 2010	\$16,446,734	\$131,119	\$45,961	\$25,577
Change 2010 to 2021, not adjusted for inflation	+\$16,027,666	+\$49,577	+\$14,903	+\$12,642
Percentage change	+97%	+38%	+32%	+49%
Inflation, 2010-2021 (CPI-U, nationwide)	24%			

## Tourism

The Maine Office of Tourism (MOT) publishes visitor information for the “Maine Highlands” region, which encompasses Penobscot and Piscataquis counties, and includes the Pickett region.<sup>v</sup> It also includes the city of Bangor which, according to MOT surveys, is the region’s primary destination. Table 8 below shows the most population attractions for overnight visitors to the region.

<sup>v</sup> The LUPC specified the Maine Highlands region as the appropriate tourism region to include in this socioeconomic report. See Appendix N for a map of all tourism regions.

*Table 8: Maine Highlands Top Attractions for Overnight Visitors, 2019<sup>12</sup>*

35%	Bangor Mall	9%	Moosehead Marine Museum (Greenville)
29%	Baxter State Park	9%	Mt. Katahdin
21%	Hollywood Casino (Bangor)	7%	Peaks Kenny State Park (Dover-Foxcroft)
17%	Moosehead Lake	7%	Mt. Kineo
14%	Maine Beer Trail	6%	Page Farm & Home Museum (Orono)
13%	Lily Bay State Park (Greenville)	6%	Patten Lumberman’s Museum
13%	UMaine Museum of Art (Orono)	5%	Gulf Hags
13%	Sebec Lake	5%	Maine Forest and Logging Museum (Bradley)
12%	Bangor Waterfront Concert Series	5%	Penobscot Theatre (Bangor)
12%	Dysart’s Restaurant and Truck Stop (Bangor)	5%	Curran Homestead (Orrington)
10%	Maine Discovery Museum (Bangor)	4%	Katahdin Iron Works (Brownville)
10%	Collins Center for the Performing Arts (Orono)	4%	Wabanaki Art Center
10%	Cole Land Transportation Museum (Bangor)	4%	Thomas Hill Standpipe (Bangor)

According to MOT publications, this vast region attracted over 907,000 visitors in 2021, about 6% of the state total, and visitor spending supported the equivalent of about \$879 million in regional economic activity. This reflects both the direct economic impact on tourism related businesses and the indirect impact on other businesses in the community. In total, MOT estimates that visitor spending in the Maine Highlands supported the equivalent of about 9,400 jobs, \$296 million in earnings, and \$75 million in tax revenue.<sup>13</sup>

Taxable sales at restaurants and lodging establishments help approximate what percentage of this spending may have occurred in the Pickett region (Table 9). In 2021, these sales were \$36 million, which represented 0.8% of statewide restaurant and lodging sales. Across Maine, sales at these tourism-related businesses accounted for 14.7% of all retail sales. In Houlton ESA and Patten ESA, that percentage was lower (10.0% and 11.5% respectively) while in Millinocket ESA it was significantly higher (22.6%). Maine’s tourism economy has grown robustly in recent years. Statewide restaurant and lodging sales rose 78.3% from 2010 to 2021. Growth was much lower in the Pickett region, ranging from 29.4% in Patten to 36.7% in Houlton and 40.1% in Millinocket.

*Table 9: Restaurant and Lodging Sales<sup>14</sup>*

	Maine	Houlton ESA <sup>15</sup>	Millinocket ESA <sup>16</sup>	Patten ESA <sup>17</sup>
<b>2010 (\$ thousand)</b>	\$2,672,972	\$13,248	\$9,823	\$3,403
<b>(percentage of total sales)</b>	16.3%	10.1%	21.4%	13.3%
<b>2021 (\$ thousand)</b>	\$4,766,321	\$18,104	\$13,762	\$4,402
<b>(percentage of total sales)</b>	14.7%	10.0%	22.6%	11.5%
<b>Change, 2010-21</b>	+78.3%	+36.7%	+40.1%	+29.4%

Two forms of tourism and local recreation that provide significant revenue to the region and state are snowmobiling and ATV use. A 2020 report on snowmobiling estimated its impact on the Maine economy (statewide) to be more than \$600 million during the 2018-19 season. In that year, 60,000 snowmobiles were registered by Maine residents and 25,000 were registered by non-residents. Spending on trips (as opposed to spending on the snowmobile itself) was more than \$200 million. Forty-six percent of resident snowmobilers and 45% of non-resident snowmobilers visited the Maine Highlands region, making it the most visited tourism region in Maine with resident snowmobilers and the second most popular with non-



residents. In all, an estimated 523,000 “snowmobiling days”<sup>vi</sup> took place in the Maine Highlands region during the 2018-19 season.<sup>18</sup>

A 2005 study found that ATV user activity contributed \$200 million to the state economy in the 2003-04 season. This value is likely significantly larger now, both due to cost inflation and the increased popularity of ATV use. For example, there are now 70,000 registered ATVs compared to 59,000 in the 2003-04 season.<sup>19</sup> In 2003-04, the Maine Highlands region was the most popular region for ATV riders, with an estimated 24% of all rides happening in the region and 35% of all riders riding in the area.<sup>20</sup>

## Housing<sup>vii</sup>

There are just under 20,000 housing units in the Pickett region, 2.6% of Maine’s total. The 11,140 units in Houlton LMA represent 27.8% of all homes in Aroostook County. Millinocket LMA’s 7,991 units equal 10.5% of Penobscot County’s total. The age of these units reflects the history of the region, especially in Millinocket where construction activity appears to have paralleled the rise and fall of the forest products industry as a dominant employer. Due to outmigration and slow population growth, housing vacancy rates are high. Homeownership in the region is generally affordable, despite low incomes, but finding affordable rental housing may be a challenge.

### Age of Housing Stock

The age distribution of homes in Houlton LMA is similar to the state average, with 28% of residences built before 1950, 43% built between 1950 and 1990, and 29% construction after 1990 (Table 10). By contrast, Millinocket LMA’s housing stock reflects the surge of home construction that occurred when the area’s population peaked in the 1960s and 1970s.<sup>21</sup> Nearly 2 out of 3 homes (64%) were built between 1950 and 1990. Just 17% were after 1990. Since 2010, Census estimates suggest that just 134 homes have been built in Millinocket LMA, compared to over 560 in Houlton LMA.

Table 10: Year Built

	Maine	Aroostook County	Penobscot County	Houlton LMA	Millinocket LMA
<b>Before 1950</b>	28%	29%	25%	28%	19%
<b>1950-1990</b>	42%	48%	45%	43%	64%
<b>Since 1990</b>	29%	23%	30%	29%	17%

### Occupancy

The decline of the forest products industry as a dominant employer, and the resulting outmigration of residents, has left many vacant homes in the Pickett region (Table 11). More than 40% of housing units in Millinocket LMA are estimated to be vacant as of 2020, as are nearly one-third (32.7%) in Houlton LMA. Elsewhere in Aroostook County and Maine, that ratio is about one-fourth (26.0% and 23.7% respectively), and in Penobscot County, just 17.1% of housing units were vacant in 2016-20.

<sup>vi</sup> A snowmobile day represents a single snowmobile in a region for some part of a day.

<sup>vii</sup> See Appendix D for data sources and additional detail.

Table 11: Occupancy

	Maine	Aroostook County	Penobscot County	Houlton LMA	Millinocket LMA
<b>Total housing units</b>	746,793	40,007	76,088	11,140	7,991
<b>Occupied housing units</b>	569,551	29,594	63,073	7,502	4,698
<b>Occupancy rate</b>	76.3%	74.0%	82.9%	67.3%	58.8%
<b>Vacancy rate</b>	23.7%	26.0%	17.1%	32.7%	41.2%

### Housing Affordability

MaineHousing statistics suggest that homeownership in the Pickett region is affordable for most residents, especially compared to elsewhere in Maine. In 2021, median home prices in Houlton LMA and Millinocket LMA (\$115,000 and \$109,000, respectively) were just 37% of the statewide median (\$295,000). Despite lower incomes, fully 59.6% and 62.0% of households in Houlton LMA and Millinocket LMA, respectively, could afford to purchase a median-priced home in their area, compared to 38.4% statewide. This means they could pay for a median-priced home using no more than 28% of their income. In Houlton LMA, this percentage has fallen slightly from 62.6% in 2010, while in Millinocket LMA, it has fallen more significantly from 78.2%. These percentages reflect both the cost of local homes and the income level of the location population.

Households that rent tend to have lower incomes and face different expenses. MaineHousing considers rent affordable if a household can cover the cost a median-priced two-bedroom unit using no more than 30% of its income. By this measure, 48.9% of renter households in Millinocket LMA could afford the median rent in 2020, compared to 45.0% statewide. In Houlton LMA, 49.2% of renters could afford the average rent in 2017 (the most recent year for which data are available), compared to 45.0% statewide.

### Public Health<sup>viii</sup>

In Maine, data on most health conditions and risk factors is available at the county level. This limits the level of detail available on residents of the Pickett region. Statistics suggests a slightly lower percentage of residents have health insurance than the state average, but the impact on health outcomes is unclear.

#### Health Insurance

In 2016-2020, the percentage of residents in Houlton LMA (88.2%) with health insurance coverage trailed the state average, while Millinocket LMA was equivalent to the statewide coverage rate of 92.4%. This is somewhat surprising since these areas are older than the state average, and nearly all older Americans are eligible for Medicare. Whereas 20.6% of Maine residents are age 65 and older, in Houlton LMA and Millinocket LMA that percentage is 22.9% and 28.0%, respectively. The lack of health insurance coverage for the overall population may reflect a lack of jobs providing this benefit to younger residents.

#### Health Conditions and Risk Factors

In 2019, the percentage of Aroostook County and Penobscot County adults who smoked was above the state average (22% and 20%, respectively, compared to 19% statewide), as was the percentage of adults who were obese in 2019, 38% and 35%, respectively, compared to 31% statewide.

<sup>viii</sup> See Appendix E for data sources and additional detail.

In 2016-2018, the time period of the Maine Center for Disease Control's most recent snapshot report, the overall cancer rate in Penobscot County was significantly higher than the state average (525.2 cases per 100,000 population versus 473.2 cases statewide). This difference is perhaps due in part to the county's significantly higher rate of prostate cancer (109.7 compared to 98.2 statewide). Aroostook County's cancer rate (460.2) was slightly lower than Maine's, despite a significantly higher rate of colon and rectum cancer (48.6 compared to 34.8 statewide). Compared to 2008-2010, overall cancer rates have declined in Maine as well as in Aroostook and Penobscot Counties. These cancer rates control for the age of the populations in each region.

In both Aroostook and Penobscot counties, the prevalence of three other health conditions have all trended in the same direction as the state: death rates for diabetes have risen, and deaths rates for coronary heart disease and strokes have declined.

## 2. Economic Impact of the Proposed Pickett Mine Project on Regional Output, Earnings, and Jobs

### Key Findings

This section provides an estimate of the economic impact of the Project in terms of spending, output, earnings, and employment. In total, the Project expects to spend \$622 million dollars<sup>ix</sup> during fourteen years of planning and operations of the Project (excluding contingency spending), of which \$340 million is expected to be spent with businesses located within the economic region of Aroostook and Penobscot Counties. As that spending ripples through the regional economy, a total impact of \$715 million in output (business sales), \$248 million in earnings, and 4,540 job-years (roughly 324 jobs per year for 14 years, inclusive of both Wolfden’s direct employment and the multiplicative employment impact related to the Project) will be created within the regional economy. Including contingency spending, which is budgeted to be spent but not yet tied to specific budget items, the overall impact increases to an estimated \$743 million in output (business sales), \$258 million in earnings, and 4,720 job-years (Table 12).

Table 12: Economic Impact

<i>Impact Excluding Contingency Spending</i>			
<b>Total Spending</b>	Total Output	Total Earnings	Total Job-Years
<b>\$622,123,219</b>	\$714,523,300	\$247,845,700	4,540
Implied Multipliers*	1.1	0.4	7.3
<i>Impact Including Contingency Spending</i>			
<b>Total Spending</b>	<b>Total Output</b>	<b>Total Earnings</b>	<b>Total Job-Years</b>
<b>\$646,864,600</b>	\$742,939,300	\$257,702,300	4,720
Implied Multipliers*	1.1	0.4	7.3

\*The implied multipliers follow the methodology used in the RIMS II model: the multiplier for output = the total output divided by total spending; the earnings multiplier = total earnings divided by total spending; the multiplier for job-years equals total job-years per million dollars of total spending.

### Data Sources

The input data used in the economic modeling comes from a 2022 third-party financial model generated by A-Z Mining Professionals Inc., a comprehensive accounting of the Project’s expected revenue and expenses for both the mine and off-site concentrator/tailings facility. Their model consisted of more than a dozen linked spreadsheets that, collectively, aggregate to the cash flow summary in the petition (Exhibit 10). For this analysis, the expenses in the A-Z financial model were adjusted by additional information supplied from Wolfden to reflect the portion of spending that is expected to incur at local businesses within the economic region (see Appendix for details).

The economic impact estimates related to employment, earnings, and output use the Regional Input-Output Modeling System (RIMS II) created and maintained by the U.S. Bureau of Economic Analysis.<sup>x</sup>

<sup>ix</sup> See Appendix M for differences between the operational spending used in the economic modeling and spending reported in the Preliminary Economic Assessment (PEA) petition (Exhibit 10).

<sup>x</sup> For more information on RIMS II, see [http://www.bea.gov/regional/pdf/rims/rimsii\\_user\\_guide.pdf](http://www.bea.gov/regional/pdf/rims/rimsii_user_guide.pdf).

RIMS II multipliers help quantify the impact of the proposed mining Project in a region in two ways: first, through purchases the Project makes as part of its production process, for example by purchasing materials like concrete and services like accounting; and second, through increased regional spending from additional earnings by the project's own employees and employees in the industries that supply the Project's inputs. See Appendices G and H for more detailed descriptions of RIMS II and the methodology used in this report.

## Defining the Region

The LUPC recommended a number of factors for consideration when defining the appropriate geographic region where the economic impact of the proposed Project will be felt, including the following:

1. The labor markets from which the Project will draw employees; in this case, the Project's workforce is expected to be drawn mostly from the two closest labor market areas: Houlton and Millinocket. These labor market areas are defined by the Maine Department of Labor based on commuting patterns.
2. The supply chain of businesses that will supply goods and services to the Project; this will extend beyond the labor market areas farther into Aroostook and Penobscot counties.
3. The location of the Project's nearest "regional service centers," as defined by the Maine Department of Agriculture, Conservation, and Forestry, which are Houlton in Aroostook County (40 miles away) and Millinocket in Penobscot County (50 miles away).<sup>22</sup>
4. The location of the nearest "rural hubs," as defined by the Maine LUPC; these include towns to the north, south, and east that cover both Aroostook and Penobscot counties and include Medway, Millinocket, Lincoln, Patten, Island Falls, Oakfield, Houlton, and Ashland.<sup>23</sup>
5. The proximity of federal "Opportunity Zones" which offer tax incentives for investments in low-income communities; two Opportunity Zones are located roughly 50 miles to the south in Penobscot County, Millinocket and East Millinocket; and several are located about 100 miles to the north, in Aroostook County, encompassing the stretch from Washburn to Madawaska.
6. The planned state, county, and local transportation routes used during each phase of the Project; the Project expects ore haul trucks from the Project Area to utilize private roads, State Route (SR) 11, SR-159, or SR-158 to reach an ore processing and concentrator facility located in a satellite location (exact location is yet to be identified). After ore processing, haul trucks would use Interstate 95 to take ore concentrate to the commercial market. Figures 21-1 and 21-2 in the Petition provide additional details. Additionally, the Project expects small vehicle traffic from workers and site visitors living in various locations within Aroostook and Penobscot Counties to funnel into Route 11 from the north or the south and enter the project site via the existing access road off Route 11. There will also be additional daily trips of deliveries from contractors to the Project, which are also expected to follow the above-described route along Route 11 to the existing access road.

Adding to the considerations listed above are the limitations of the underlying data on inter-industry sales and consumer purchasing behavior. The RIMS II economic model, a well-regarded and accessible input-output model that the U.S. Bureau of Economic Analysis maintains and that this report utilizes for estimating the economic impact of the Project's spending, relies on publicly available data collected at the county level; it does not provide multipliers at geographies smaller than a county.<sup>24</sup> Given this constraint and the considerations above, the combined region of Aroostook County and Penobscot



County is chosen as the region for which to estimate the economic impacts related to employment, earnings, and output. This is herein referred to as the “economic region.” While this region is considerably larger than the Project’s footprint, it accurately reflects where most workers and supplies will be drawn from. In addition, while the economic data does not allow for a hyper-local estimate of the economic impact on, say, the town of Patten, it is fair to assume that the economic impact described below will be felt most acutely by the towns closest to the Project and will dissipate with distance.

## Wolfden Direct Expenditures

The 2022 financial model developed by A-Z Mining Professionals Inc. and used by Wolfden in their cash flow analysis estimates spending by type (capital expenditures and operating expenses),<sup>xi</sup> project category (Underground Development, Infrastructure, etc.), and year. Spending by year is further summarized into two time periods that together span the fourteen years of the project: a “start-up” time period which includes the two years prior to the mine’s operations; and an “operations” time period which includes ten years of operations and two years of closure (twelve years in all).<sup>xii</sup> In total, the Project expects to spend more than \$622 million over fourteen years, of which an estimated \$340 million (55%) is expected to be spent within the economic region (See Table 15). Note that this does not include roughly \$25 million in contingency spending and \$9 million in planned reclamation costs, which are expected to be spent but have not yet been earmarked for specific budget items. Contingency spending is addressed in a separate section. See Appendix I for more details on the assumptions used to estimate the intraregional spending.

### Capital Expenditures

The Project expects to spend approximately \$203 million in capital expenses (Table 13). Roughly half will be spent in the start-up phase of the Project and half will be spent during the operations phase. Ninety-two million dollars, or 45%, is expected to be paid to employees or businesses within the economic region, split roughly equally between the start-up and operations phase.

Table 13: Capital Expenditures

	Start-up	Operations	Total Spending
<b>All</b>	\$102,610,000	\$99,957,400	\$202,567,400
<b>Within Economic Region</b>	\$50,028,900	\$41,906,300	\$91,935,200
<b>% in Region</b>	49%	42%	45%

### Operating Expenses

The Project expects to spend approximately \$420 million in operating expenses,<sup>xiii</sup> virtually all within the operations phase of the Project (Table 14). Two hundred forty-eight million dollars, or 59%, is expected to be paid to employees or businesses within the economic region.

Table 14: Operating Expenses (not including contingency spending)

<sup>xi</sup> Capital and operating expenses in the Wolfden financial model are defined in a specific way for mining projects: capital expenses include spending that occurs before the project reaches 60% of the “nameplate” production capacity output; operating expenses are those that occur after this threshold has been reached.

<sup>xii</sup> These two time periods were chosen to present separately because they represent distinct phases of the Project with large amounts of spending. The final two years of the Project are included within the operations time-period because of the relatively small amount of spending that occurs in that phase (approx. 0.2%).

<sup>xiii</sup> Not including \$25 million in contingency spending and \$9m in reclamation costs.

	<b>Start-up</b>	<b>Operations</b>	<b>Total Spending<sup>xiv</sup></b>
<b>All</b>	\$6,811,000	\$412,744,800	\$419,555,800
<b>Within Economic Region</b>	\$4,245,900	\$243,547,100	\$247,793,100
<b>% in Region</b>	62%	59%	59%

### Total Expenses

In all, Wolfden projects spending of \$622 million on the proposed Project,<sup>xv</sup> of which \$340 million (55%) is expected to be paid to employees or businesses within the economic region (Table 15). This estimate of \$340 million of spending within the economic region is based on Wolfden’s estimates of the amount of labor and materials that will be procured locally. Appendix I lists the local procurement estimates for each of 125 budget items that make up the total Project’s costs. For example, Wolfden estimates that 50% of the materials and 80% of the labor associated with water treatment expenses in the operations phase of the Project will be procured locally. The total expenses for each of these 125 budget items are multiplied by the local procurement estimates to derive the estimate of total spending within the region, which totals \$340 million or 55% of total expenses (Table 15). Because the amount of materials and labor that will be procured locally cannot be definitely known at this time, alternative scenarios of economic impact assuming lower and higher local procurement estimates are also shown in the section below labeled “Caveats and Limitations.” Note also that Wolfden has indicated that it plans to maximize the amount of business it does with local businesses; strategies to do so are outside the scope of this report and are described by Wolfden in Exhibit 10 of the petition. Note also that much of the balance will be spent within Maine, just not within the economic region. In this way, the economic impacts described below are conservative in that they do not include benefits that accrue to Maine outside of the Pickett region.

*Table 15: Total Spending (not including contingency spending)*

	<b>Start-up</b>	<b>Operations</b>	<b>Total Spending<sup>xiii</sup></b>
<b>All</b>	\$109,421,000	\$512,702,200	\$622,123,200
<b>Within Region</b>	\$54,274,800	\$285,453,400	\$339,728,200
<b>% in Region</b>	50%	56%	55%

### Expenses Within LUPC Region

While the appropriate geographic region for the economic impact is the combined region of Aroostook and Penobscot counties (see Defining the Region, above), direct spending related to Project infrastructure and operations within the LUPC jurisdiction will be somewhat less. Based on estimates supplied by Wolfden, roughly \$401 million or 64% of total Project spending will be related to the mine and its operations located in the LUPC jurisdiction, while the remaining 36% of Project spending will be related to the concentrator and tailings management facility, which will be located in a nearby town. Looking just at the portion of spending that accrues to firms and people within the economic region, roughly 68% or \$232 million will be related to the mine itself, with the remaining balance related to the concentrator and tailings facility. See Appendix J for more details.

<sup>xiv</sup> See Appendix M for differences between the operational spending used in the economic modeling and spending reported in the Preliminary Economic Assessment (PEA) petition (Exhibit 10).

<sup>xv</sup> Not including \$25 million in contingency spending and \$9 million in reclamation costs

Table 16: Total Spending (not including contingency spending)

	Start-up	Operations	Total Spending <sup>xvi</sup>
<b>All Spending</b>	<b>\$109,421,000</b>	<b>\$512,702,200</b>	<b>\$622,123,200</b>
<i>Related to Project Within LUPC</i>	<i>\$63,208,515</i>	<i>\$337,614,195</i>	<i>\$400,822,710</i>
<i>% Related to Project in LUPC</i>	<i>58%</i>	<i>66%</i>	<i>64%</i>
<b>Spending Within Economic Region</b>	<b>\$54,274,800</b>	<b>\$285,453,400</b>	<b>\$339,728,200</b>
<i>Related to Project Within LUPC</i>	<i>\$28,235,185</i>	<i>\$204,149,332</i>	<i>\$232,384,517</i>
<i>% Related to Project in LUPC</i>	<i>52%</i>	<i>72%</i>	<i>68%</i>

### Employment and Wages

Embedded in the projections above are the hiring of 230 full-time employees who are expected to live within the economic region (Tables 17 and 18). In terms of administrative staff, 16 hires are projected, 10 of whom are expected to be hired within the economic region. Projected annual salaries range from \$48,000 and \$198,000 with an estimated average salary (weighted by hires) of \$73,000, one and a half times the average wage in the economic region (Table 17).

Table 17: General Administrative Staff

Position	# Hires	# Hires Expected to Live in Economic Region	Salary Range	% of Avg Wage vs LMAs	% of Avg Wage vs Economic Region
Mine Manager	1	-	-	-	-
Mine Superintendent	1	-	-	-	-
Mill Superintendent	1	-	-	-	-
Technical Services Superintendent	1	-	-	-	-
Senior Engineer	1	-	-	-	-
Accountant	1	1	\$60-90,000	185%	157%
Eng/Geo technicians	2	1	\$72-198,000	334%	282%
Warehouse Manager	1	1	\$112-168,000	346%	292%
Environment Coord.	1	1	\$64-96,000	198%	167%
Medical Contract	1	1	\$48-72,000	148%	125%
Security Guard	4	4	\$36-54,000	111%	94%
Site Services	1	1	\$48-72,000	148%	125%
<b>Total / Average</b>	<b>16</b>	<b>10</b>	<b>\$73,000</b>	<b>180%</b>	<b>152%</b>

Note that the average salary and the comparisons to wages in LMA and economic region are calculated assuming each position is paid at the middle of the salary range. Average salary is weighted by hires.

In addition to the administrative staff identified above, the Project expects to hire approximately 220 additional on-site staff, all of whom are expected to live within the economic region. These employees

<sup>xvi</sup> See Appendix M for differences between the operational spending used in the economic modeling and spending reported in the Preliminary Economic Assessment (PEA) petition (Exhibit 10).

will fill 110 distinct positions over two daily shifts (Table 18). The lowest paid staff will earn between roughly \$15 and \$35 dollars an hour.<sup>xvii</sup> On average, the on-site full-time staff will earn wages of roughly \$64,000 per year, 33% higher than the average wage in the economic region.

(Note that these numbers reflect only the employees the Project expects to directly hire as Wolfden employees. In the first several years of the Project, it plans to contract with regional companies for much of the site work; the companies will supply their own employees. Once the mine is operational, the Project will transition to more direct hiring and continuous training.)

*Table 18: On-site Staff*

Position	Daily Positions	# Hires Expected to Live in Economic Region	Hourly / Salary Range	% of Avg Wage vs LMAs	% of Avg Wage vs Economic Region
<b>UG Equipment Operator</b>	16	32	\$23.80 - \$34.50/ hr	150%	127%
<b>Underground Mechanic</b>	22	44	\$22.70 - \$40.00/ hr	161%	136%
<b>Underground Laborer</b>	23	46	\$15.40 - \$36.30/ hr	133%	112%
<b>Underground Miner</b>	26	52	\$20.10 - \$45.00/ hr	167%	141%
<b>Supervisor</b>	4	8	\$50.00 - \$62.00/ hr	288%	243%
<b>Mill Operations</b>	12	24	\$47,450 - \$71,200/ yr	147%	124%
<b>Mill Staff</b>	7	14	\$48,800 - \$73,200/ yr	151%	127%
<b>Total / Average</b>	110	220	\$63,690/ yr	157%	133%

*Note that the numbers in the Daily Positions column (110) reflect the fact that there are two shifts each 24-hour period; the numbers in the # of Hires Expected to Live in the Economic Region column (220) reflects that fact that employees work seven days on and then have seven days off, resulting in a doubling of the Daily Positions numbers; also note that the average salary and comparisons to wages in LMA and economic region are calculated assuming each position is paid at the middle of the salary range; the average salary is a weighted average based on hires.*

In all, Wolfden projects to spend roughly \$200 million on employee compensation over the fourteen years of the Project (Table 19).<sup>xviii</sup> To be consistent with the RIMS II economic impact methodology,<sup>xix</sup> compensation for employees hired from outside of the economic region and the portion of compensation for employee benefits and taxes are excluded from the economic modeling. This results in an input to the economic model of \$119 million in total wages, or an average of \$8.5 million in wages to local workers per year (although it will likely not be evenly distributed through the Project life).

*Table 19: Compensation and Wages*

	Total	Average Per Year
<b>Compensation for All Employees</b>	\$200,420,200	\$14,315,700
<b>Wages for Regional Employees in Economic Model</b>	\$118,891,400	\$8,492,200

<sup>xvii</sup> Salary ranges come from Virginia Tech University, sourced by a third-party consultant hired by Wolfden.

<sup>xviii</sup> Note that for the economic modeling, Project spending and compensation were used, not the estimated number of employees.

<sup>xix</sup> RIMS II defines earnings as consisting of wages and salaries and of proprietors' income, which is the net earnings of sole-proprietors and partnerships and includes employer contributions for health insurance.

## Direct Spending by Industry

The highest amount of direct Project spending, almost \$165 million, will flow to the regional construction industry for a variety of excavation, infrastructure, and building services. Just under \$10 million will be spent in the wholesale trade industry for equipment and materials ranging from drill bits to heavy machinery. About \$12 million will go to the mine support industry which in Maine currently consists mostly of support for the non-metallic mining industry, and \$119 million of spending will flow directly to Project employees within the region through their earnings.

Following the RIMS II model's convention, construction and investment expenses are summarized separately from the Project's operational expenses.<sup>25</sup> RIMS II uses a "Households" multiplier to estimate the economic impact of spending within the region related to the wages paid to Project employees (Table 21).

Table 21: Regional Spending by Industry (not including contingency spending)

Industry (NAICS) <sup>xx</sup>	Start-up (Years 1-2)	Operations (Years 3-12)	Total Regional Spending
Construction	\$34,583,300	\$130,147,300	\$164,730,700
Wholesale trade	\$1,866,900	\$7,677,700	\$9,544,600
<b>Total Construction and Investment</b>	<b>\$36,450,200</b>	<b>\$137,825,000</b>	<b>\$174,275,300</b>
Project Employee Earnings (Households)	\$2,065,200	\$116,826,200	\$118,891,400
Utilities	\$8,629,700	\$16,956,400	\$25,586,100
Support activities for mining	\$3,703,700	\$7,895,700	\$11,599,400
Professional, scientific, and technical services	*	\$4,450,000	\$4,450,000
Waste management and remediation services	\$3,426,100	*	\$3,426,100
Truck transportation	*	\$550,000	\$550,000
Administrative and support services	*	\$500,000	\$500,000
General merchandise stores	*	\$350,000	\$350,000
Financial investments and related activities	*	\$100,000	\$100,000
<b>Total Mine Operations</b>	<b>\$17,824,700</b>	<b>\$147,628,300</b>	<b>\$165,453,000</b>
<b>Total</b>	<b>\$54,274,900</b>	<b>\$285,453,200</b>	<b>\$339,728,200</b>

\* indicates that no regional spending in this NAICS industry for this phase of the project was used in the economic impact analysis. It does not, however, necessarily mean that no spending in this industry will occur during the phase (spending may occur outside of the region) or that no spending for this type of work will occur (for example, spending related to trucking materials may be classified within the support activities for mining industry as opposed to the truck transportation industry).

<sup>xx</sup> Industries are defined by the North American Industry Classification System (NAICS). More information and definitions are available here: <https://www.census.gov/naics/>



## Indirect and Induced Economic Impacts

### Summary

The \$340 million of regional spending will flow to a multitude of businesses, industries, and households within the economic region. These businesses and households will in turn purchase additional goods and services, multiplying the Project's initial investment through the regional economy. In total, the Project's spending within the economic region will support almost \$715 million in economic output (business sales, including the Project's), \$248 million in earnings (including the Project's paychecks to its employees), and 4,540 job years (roughly 324 full- and part-time jobs each year for 14 years, inclusive of the Project's direct hires) (Table 20). The estimated 324 annual jobs represent 0.4% of the total jobs in the economic region and 4.1% of jobs in the Houlton and Millinocket labor market areas. The derivation of this impact is described in the sections below and Appendices G and H have additional information on the methodology. To provide context for the magnitude of this impact, implied multipliers are also provided in Table 20; these appear reasonable and conservative compared to other industries and impact studies.

Table 20: Economic Impact (not including contingency spending)

Total Spending	Total Output	Total Earnings	Total Job-Years
<b>\$622,123,219</b>	\$714,523,300	\$247,845,700	4,540
Implied Multipliers*	1.1	0.40	7.3

\*The implied multipliers follow the methodology used in the RIMS II model: the multiplier for output equals the total output divided by total spending; the earnings multiplier = total earnings divided by total spending; the multiplier for job-years equals total job-years per million dollars of total spending.

### Economic Multipliers

The RIMS II economic model is used to derive economic multipliers specifically for the Project's economic region, defined as Aroostook County and Penobscot County. The RIMS II multipliers for output (i.e., business sales), earnings, and jobs are derived based on publicly available data that reflect the unique inter-industry and consumption patterns within the economic region. In essence, they represent the regional economic impact across all industries per-dollar of projected spending by the Project (or per-million dollars in the case of the jobs multiplier). For example, the earnings multiplier for construction of 0.50 means that for every dollar the Project spends in the local construction industry, roughly 50 cents of earnings are generated across all households in all industries in the economic region. The jobs multiplier for construction, 10.67, means that for every \$1 million the Project spends in the local construction industry, roughly 11 part- or full-time jobs are created (Table 22).

Table 22: Industry Multipliers

Industry	Total Regional Spending	Multipliers		
		Output per Dollar	Earnings per Dollar	Jobs per Million Dollars
Construction	\$164,730,700	1.59	0.50	10.67
Wholesale trade	\$9,544,600	1.45	0.36	6.66
<b>Total Construction and Investment</b>	<b>\$174,275,300</b>			
Project Employee Earnings (Households)	\$118,891,400	0.74	0.23	6.12
Utilities	\$25,586,100	1.37	0.25	3.79
Support activities for mining	\$11,599,400	1.46	0.42	8.48
Professional, scientific, and technical services	\$4,450,000	1.51	0.59	11.42
Waste management and remediation services	\$3,426,100	1.50	0.37	7.98
Truck transportation	\$550,000	1.63	0.49	10.14
Administrative and support services	\$500,000	1.57	0.60	17.67
General merchandise stores	\$350,000	1.47	0.45	16.17
Financial investments and related activities	\$100,000	1.56	0.56	15.97
<b>Total Mine Operations</b>	<b>\$165,453,000</b>			
<b>Total Regional Spending</b>	<b>\$339,728,300</b>			

### Total Output, Earnings, and Job-Years

In total, the proposed Project will create 4,540 job-years within the region and provide almost \$248 million in earnings, stemming from \$715 million in new business sales. These estimates are inclusive of the Project's initial spending and hires. The estimated 4,540 job-years represents 1,760 job-years related to spending within the construction industry and 730 job-years related to the spending in the local economy from Project employees. On an annual basis over 14 years, it represents 324 jobs per year (inclusive of the Project's direct hires). Roughly 11% (510 job-years) are expected to be created in the start-up phase and 89% (4,030 job years) in the operations phase. For both phases, spending in the construction industry creates the majority of job-years. See Table 23 for details and Appendix K for the impact by phase (i.e., start-up and operations).

Table 23: Economic Impact (not including contingency spending)

	Industry In Which Project Spending Occurs	Total Regional Spending	Output	Earnings	Job-Years
	Construction	\$164,730,700	\$262,547,700	\$82,661,800	1,760
	Wholesale trade	\$9,544,600	\$13,834,000	\$3,405,500	60
<b>1</b>	<b>Total Investment Expenditures</b>	<b>\$174,275,300</b>	<b>\$276,381,700</b>	<b>\$86,067,400</b>	<b>1,820</b>
<b>1a</b>	Project Employee Earnings (Households)	\$118,891,400	\$88,514,600	\$26,928,900	730
	Utilities	\$25,586,100	\$34,976,200	\$6,404,200	100
	Support activities for mining	\$11,599,400	\$16,910,800	\$4,907,700	100
	Professional services	\$4,450,000	\$6,723,500	\$2,603,700	50
	Waste management	\$3,426,100	\$5,143,900	\$1,261,100	30
	Truck transportation	\$550,000	\$898,200	\$269,600	10
	Administrative and support services	\$500,000	\$783,100	\$299,600	10
	General merchandise stores	\$350,000	\$515,700	\$156,000	10
	Financial investments and related	\$100,000	\$156,000	\$56,100	0
<b>2</b>	<b>Total Intermediate Expenditures</b>	<b>\$165,453,000</b>	<b>\$154,622,100</b>	<b>\$42,886,900</b>	<b>1,020</b>
<b>3</b>	<b>Regional Impact (1+2)</b>	<b>\$339,728,300</b>	<b>\$431,003,800</b>	<b>\$128,954,300</b>	<b>2,840</b>
<b>4</b>	Non-Regional Spending – Investment Expenditures	\$164,329,600			
<b>5</b>	Non-Regional Spending - Intermediate Expenditures	\$118,065,300			
<b>6</b>	<b>Total Project Spending (3+4+5)</b>	<b>\$622,123,200</b>			
<b>7</b>	Initial Spending on Intermediate Expenditures (2+5)		\$283,518,400		
<b>8</b>	Initial Wages to Project Employees (1a)			\$118,891,400	
<b>9</b>	Initial Project Job-Years (projections of 120 employees/year)				1,700
			<i>Output</i>	<i>Earnings</i>	<i>Job-Years</i>
<b>10</b>	<b>Total Impact (3+7+8+9)</b>		\$714,522,200	\$247,845,700	4,540
<b>11</b>	Implied Multiplier		1.1	0.4	7.3

### Output, Earnings, and Job-Years by Industry

The Project’s total economic impact described above will be spread among the major industries in the region. Whereas Table 23 reports the economic impacts related to spending in a given industry, Table 24 reports the total impact for each industry regardless of which industry the initial spending occurred. In other words, for the construction industry, Table 23 reports that \$164.7m of direct Project spending in the construction industry results in a total of 1,760 job-years in all industries, some of which are in construction but including other industries as well. Table 24 reports that total Project spending across *all* industries, not just in the construction industry, results in a total of 1,070 job-years in the construction industry.

Not surprisingly, the largest overall impact will be in the mining industry, which includes Wolfden’s direct expenditures and hiring and will realize roughly 40% of the total estimated total job-years. About a quarter of the total impact of job-years will be realized in the construction industry. Because much of the impact derives from the household spending of employees, other impacted industries follow the general industrial make-up of the region, with healthcare, retail trade, and food services collectively realizing 17% of the estimated job-years (Table 24). (Job-years by Project phase are included in Appendix L.)

Table 24: Total Economic Impact by Industry

Industry In Which Economic Impact is Realized	Output	Earnings	Job-Years
Mining, quarrying, and oil and gas extraction	\$295,135,700	\$122,191,400	1,760
Construction	\$167,711,000	\$56,100,000	1,070
Health care and social assistance	\$35,742,000	\$14,900,000	280
Utilities	\$33,218,000	\$4,800,000	40
Retail trade	\$31,322,000	\$10,200,000	370
Wholesale trade	\$23,730,000	\$5,200,000	80
Real estate and rental and leasing	\$20,664,000	\$3,300,000	180
Durable goods manufacturing	\$14,554,000	\$2,800,000	60
Professional, scientific, and technical services	\$11,826,000	\$5,100,000	90
Transportation and warehousing	\$11,036,000	\$3,400,000	70
Other services	\$10,976,000	\$3,300,000	90
Finance and insurance	\$10,215,000	\$2,400,000	40
Food services and drinking places	\$10,033,000	\$3,000,000	130
Administrative and support and waste management	\$9,800,000	\$3,100,000	90
Information	\$7,278,000	\$1,400,000	30
Nondurable goods manufacturing	\$7,182,000	\$1,100,000	20
Educational services	\$4,698,000	\$2,000,000	60
Accommodation	\$3,176,000	\$800,000	20
Management of companies and enterprises	\$2,807,000	\$1,300,000	20
Arts, entertainment, and recreation	\$1,767,000	\$600,000	20
Agriculture, forestry, fishing and hunting	\$1,642,000	\$500,000	20
<b>TOTAL</b>	<b>\$714,520,000</b>	<b>\$247,850,000</b>	<b>4,540</b>

### Maine State Taxes

The \$248 million in total earnings will result in an estimated \$5.3 million in state income taxes, \$4.3 million in state sales taxes, and \$4.3 million in local property taxes (Table 25). These estimates are based on Maine Revenue Services (MRS) 2019 tax incidence estimates.<sup>xxi</sup> The total earnings are first reduced by 30% as a way to conservatively align the RIMS II earnings definition with MRS’s methodology of taxable income. Average tax incidence rates for all households are applied to this earnings estimate. The tax estimates in Table 25 do not include any taxes that Wolfden, itself, pays to the state or local taxing

<sup>xxi</sup> Maine Revenue Services, available here: <https://www.maine.gov/revenue/taxes/tax-policy-office>

jurisdictions. They only include the taxes related to the economic impacts described above that results in earnings for workers within the Pickett region.

*Table 25: Maine Taxes (not including contingency spending)*

	<b>Sales</b>	<b>Property</b>	<b>Income</b>
<b>Taxable Income</b>	2.47%	2.48%	3.07%
<b>\$173,492,000</b>	\$4,285,300	\$4,302,600	\$5,326,200

### **Economic and Fiscal Impact Including Contingency Spending**

Wolfden’s financial projections includes a \$25 million contingency spending allocation. This was not included in the estimates above because it was not attached to specific budget items. However, given that contingency funds are an important part of Wolfden’s financial model and likely will be spent, it is appropriate to include them in the economic assessment. Table 26 re-estimates the economic impacts described above by assuming the contingency spending is distributed equally across all spending categories. Essentially, all impact estimates are increased by 4.0%, reflecting the percent increase in total spending if contingency spending is included.

*Table 26: Economic Impact Including Contingency Spending*

<b>Total Spending</b>	<b>Total Output</b>	<b>Total Earnings</b>	<b>Total Job-Years</b>
<b>\$646,864,600</b>	\$742,939,300	\$257,702,300	4,720
Implied Multipliers	1.1	0.4	7.3

*Table 27: Maine Taxes Including Contingency Spending*

	<b>Sales</b>	<b>Property</b>	<b>Income</b>
<b>Earnings</b>	2.47%	2.48%	3.07%
<b>\$180,391,600</b>	\$4,455,700	\$4,473,700	\$5,538,000

### **Caveats and Limitations**

The economic impact estimates above are subject to important caveats and limitations. The inputs to the economic model are wholly dependent on A-Z Mining Professionals Inc. estimates of spending and Wolfden’s projections for the level of spending to occur within the economic region. If less spending occurs than projected, or if a higher portion of spending goes to businesses or workers outside of the region, the economic impact will be less than the estimates contained in this report. Conversely, if more spending occurs, or if more spending goes to local businesses or workers, the economic impact will be greater. The primary constraint to hiring local employees will be the skills of workers in the labor market. If qualified laborers are lacking in the economic region, the Project will have to import labor from elsewhere. Unless workers permanently relocate to the region, this would reduce the economic benefit to the Pickett region. To get a rough sense of the scale of potential over- or underestimation, Table 28 below provides estimates of the economic impact under the scenarios that the portion of spending to regional business is 80% to 120% of projected. In the low scenario, 3,630 job-years are created, while 5,450 job-years are created in the high scenario.



*Table 28: Low and High Economic Impact Scenarios*

	<b>Low</b>	<b>Estimate</b>	<b>High</b>
<b>Total Regional Spending</b>	\$497,698,600	\$622,123,200	\$746,547,900
<b>Output</b>	\$571,618,600	\$714,523,300	\$857,427,900
<b>Earnings</b>	\$198,276,500	\$247,845,700	\$297,414,800
<b>Job Years</b>	3,630	4,540	5,450

Further, the analysis assumes that no unforeseen environmental damage occurs as a result of the Project. The likelihood of environmental damage or the sufficiency of the Project’s environmental safeguards (including a reclamation fund committed at the start of the Project) and the state’s oversight of those safeguards are beyond the scope of this report. If environmental damage did occur that exceeded the level that could be mitigated by the reclamation fund or other means, negative economic impacts could occur that could offset the positive impacts detailed above in terms of jobs and earnings. Speaking more broadly, the analysis in this report, like any economic analysis that follows an input-output methodology, presents only one part of the total costs and benefits related to the proposed project. The Project’s economic impact, although critical to consider, should be weighed alongside other important environmental, community, social, tribal, and other values. In short, the economic impact described in this report should not be viewed as an endorsement for the Project, but rather as critical context for policymakers and stakeholders to consider.

### 3. Other Economic Impacts (Qualitative Assessments)

#### Key Findings

This section provides a qualitative assessment of the impact of the proposed Project on tourism, housing, and job training. As long as the Project is successful in its plan to hire local workers within an hour travel distance of the Project, the impact on the local housing market will likely be negligible. Likewise, based on the Project footprint and expected operations, the impact on the Maine Highlands tourism market will also likely be negligible. Finally, if the Project provides formal training to the region’s workers in partnership with a regional college, additional positive economic impacts related to professional developments may accrue to the region and its residents and extend beyond the timeline of the Pickett Project.

#### Impact on the Tourism Industry

The tourism industry is often conflated with the local demand from residents for recreation and entertainment. From an economic development perspective, a region’s tourism industry represents the regional spending by visitors from outside of the region (preferably overnight visitors outside of the state). The Maine Office of Tourism researched the most popular attractions for overnight visitors in the Maine Highlands Region, which includes the Pickett region. Table 29 lists those attractions and their approximate distance by road to the Pickett Project. With the exception of the Patten Lumberman’s Museum, all are located at a considerable distance from the Project (more than an hour’s drive away) and none are expected to be negatively affected by the Project’s operations, noise, or infrastructure. It is reasonable to assume that the Pickett Project will have no impact on visits to the region’s primary tourism attractions.

Table 29: Maine Highlands Top Attractions for Overnight Visitors, 2019<sup>26</sup>

Attraction	% Visiting	Aprox. Driving Miles from Pickett Mine
Bangor Mall	35%	97
Baxter State Park	29%	49 (to Millinocket)
Hollywood Casino (Bangor)	21%	102
Moosehead Lake	17%	117
Maine Beer Trail	14%	n/a
Lily Bay State Park (Greenville)	13%	109
UMaine Museum of Art (Orono)	13%	93
Sebec Lake	13%	107
Bangor Waterfront Concert Series	12%	99
Dysart’s Restaurant and Truck Stop (Bangor)	12%	104
Maine Discovery Museum (Bangor)	10%	100
Collins Center for the Performing Arts (Orono)	10%	93
Cole Land Transportation Museum (Bangor)	10%	102
Moosehead Marine Museum (Greenville)	9%	133
Mt. Katahdin	9%	74
Peaks Kenny State Park (Dover-Foxcroft)	7%	105
Mt. Kineo	7%	123
Page Farm & Home Museum (Orono)	6%	93

Attraction	% Visiting	Aprox. Driving Miles from Pickett Mine
Patten Lumberman’s Museum	6%	10
Gulf Hugas	5%	99
Maine Forest and Logging Museum (Bradley)	5%	97
Penobscot Theatre (Bangor)	5%	100
Curran Homestead (Orrington)	5%	108
Katahdin Iron Works (Brownville)	4%	83
Wabanaki Art Center	4%	118
Thomas Hill Standpipe (Bangor)	4%	100

Snowmobiling and ATV riding are also important parts of tourism and local recreation in the Maine Highlands region. For snowmobilers, the Highlands region is the most visited tourism region with residents and the second most visited with non-residents;<sup>27</sup> for ATV riders, it is the most visited.<sup>28</sup> Both snowmobilers and ATV riders generally ride long distances: for example, resident snowmobilers drove an average of 780 miles in 2018-19, while non-residents drove an average of 973 miles. No snowmobile or ATV trails are within the proposed rezone area.

Publicly available data on other forms of recreation like hiking, hunting, and fishing taking place within the Pickett region are sparse and it is unclear how large an economic market these forms of recreation make up, and how many people from outside the region come to the Pickett region to recreate. While there are trails nearby, none are within the Project boundaries. Pickett Mountain is not a world-class tourism attraction like Mount Katahdin, nor does it have “gateway-community” amenities close by. The Project’s footprint will be less than a square mile in a region of thousands of square miles of recreational opportunities. Wolfden has also publicly stated it does not intend to revoke public access to its more than 6,800 acres of adjacent land for hunting or trail use. All of these factors lead to the reasonable conclusion that the proposed Project will have little to no negative effect on the regional tourism industry, with one caveat: the assessment of little-to-no negative tourism impact assumes, importantly, that the Project does not harm the environmental quality of the larger region.<sup>xxii</sup>

### Impact on the Housing Market

Home prices and rents in the Pickett region are affected by myriad factors that drive the overall supply and demand for housing in the region. Two primary drivers of demand, today, are a declining population and residents’ relatively low incomes, both of which constrain demand for both new and/or higher-end housing options. A third demand driver – an aging population – is poised to impact preferences for the type and location of housing in the region as the housing needs for older residents change as they age. The supply of the region’s housing is also complex, influenced in large part by its history as an industrial powerhouse. The region’s housing stock is predominantly single-family homes, which are relatively older and less expensive than in other regions. Today, all these factors interact in the form of house prices and rents that are lower than the statewide average and a housing vacancy rate that is above the state average, particularly in Houlton LMA (32%) and Millinocket LMA (41%). There are over 6,900 vacant housing units in the two labor market areas.

---

<sup>xxii</sup> Note that this is a qualitative assessment only as we are not aware of studies that have quantified or correlated the economic impact, if any, of small-scale mining on broader regional tourism.

Will the proposed mining Project increase housing prices and rents? There are several reasons to conclude the proposed Project will have little-to-no effect on housing prices and rents. First, the fundamental forces described above are long-term and deeply embedded into the market. It would be difficult for a project of finite length (14 years) to offset these long-standing trends. Second, the Project plans to hire 230 workers from the local economic region within about an hour from the site (as shown in Tables 17 and 18). While it is uncertain at this point in the planning process if the Project will be able to do so, it is certainly in its financial best interest to hire local workers. Wolfden indicates that most of these workers will work “7-on, 7-off” schedules where they are on-site each day for a full week and then off work for the following week. As long as the Project is able to successfully hire from the local population of commuters, there will not be a substantial increase in demand for housing. To the extent that some workers will prefer to rent or buy a home closer to the Project instead of commute, the high vacancy rate in the region will likely be able to absorb a modest impact on demand with little effect on overall pricing fundamentals.

This assessment is dependent on the Project’s ability to hire local workers once the mine is operational. If the Project is unable to hire from the local region and instead imports workers from outside of the region, the likelihood that this change in demand for housing pushes housing prices (likely rents) higher will increase.

## Impact of Economic Incentives

The economic analysis detailed above assumes that no taxpayer-funded state or federal economic incentive programs are used to subsidize Wolfden capital or operating expenses.

## Impact of Project-Sponsored Training Programs

In order to hire local workers with the requisite skills for the proposed project, Wolfden has stated its intention to:

- develop a training program in conjunction with a local community college
- work directly with high schools to offer science fairs and job fairs for local students to develop knowledge of mining in potential future employees
- develop a series of educational programs for employees focused on financial planning and management, and
- provide supports for employees in finding their next job within the mining industry.

The direct impact from the spending on these trainings during the construction and operation phases of the Project are embedded in the economic analysis detailed above. However, since these training and support programs will teach mining skills that are transferable to other mining projects, the economic benefit may extend beyond the Project’s timeline as some of the region’s skilled workers find work and earn wages at other mines around the country (and spend a portion of those wages in the regional economy). To fully quantify the economic impact of professional development on the regional economy one would need to know the number of trainees expected to go through the program and their expected wages before and after training. However, one way to appreciate the *potential* impact is to note that the average wage in the Pickett economic region is roughly \$48,000, 30% less than the expected average wage of \$69,000 for on-site workers at the Pickett project. Additional details on the planned training programs is provided elsewhere in the petition (Exhibit 10).

## Geographic Location of Businesses in Economic Area and Impact of Transportation

The maps in Appendix O and Figures 21-1 and 21-2 in the Petition, created by Stantec, show, respectively, the geographic location of businesses within the regional labor market area and the Project's anticipated transportation route for shipping concentrate. Population data by road is not publicly available but the population information provided in Section 1 of this report describe the general population and density characteristics of the closest towns and for the economic region as a whole. In terms of the economic impact of the of the transportation, the Project's spending associated with trucking materials to and from the mine and the regional spending associated with the wages paid to truck drivers are included in this report's economic analysis. The economic impact to specific businesses along the route is impossible to quantify at this point in time.



## 4. Appendices

### Appendix A: Population

	Maine	Aroostook County	Penobscot County	Houlton LMA	Millinocket LMA
<b>POPULATION<sup>29</sup></b>					
1970	993,722	92,463	125,393	20,541	13,364
1980	1,125,043	91,331	137,015	20,300	13,799
1990	1,227,928	86,936	146,601	20,102	13,240
2000	1,274,923	73,938	144,919	18,969	11,035
2010	1,328,361	71,870	153,923	18,683	9,770
2020	1,362,359	67,105	152,199	18,048	9,092
<b>POPULATION DENSITY</b>					
Land area (square miles) <sup>30</sup>	30,845	6,671	3,397	1,086	3,378
People per square mile (2020)	44.2	10.1	44.8	13.5	2.7
<b>AGE<sup>31</sup></b>					
Percentage of population by age					
0-4 years	4.8%	4.9%	4.6%	4.7%	2.9%
5 to 9 years	5.1%	5.1%	5.1%	5.6%	7.2%
10 to 14 years	5.4%	4.9%	5.1%	5.6%	3.5%
15 to 19 years	5.8%	5.6%	6.9%	6.6%	3.7%
20 to 24 years	5.6%	5.2%	6.9%	5.2%	2.6%
25 to 29 years	6.0%	5.0%	6.8%	4.1%	5.0%
30 to 34 years	6.0%	4.9%	6.5%	4.6%	4.8%

	Maine	Aroostook County	Penobscot County	Houlton LMA	Millinocket LMA
35 to 39 years	5.8%	5.3%	5.4%	5.4%	5.3%
40 to 44 years	5.7%	5.1%	5.8%	5.6%	3.9%
45 to 49 years	6.4%	6.1%	6.3%	5.6%	6.4%
50 to 54 years	7.1%	7.2%	6.9%	8.8%	7.0%
55 to 59 years	8.0%	8.5%	7.7%	7.6%	9.6%
60 to 64 years	7.8%	8.0%	7.4%	7.7%	10.1%
65 to 69 years	7.0%	7.7%	6.1%	7.5%	9.1%
70 to 74 years	5.2%	6.0%	4.9%	6.2%	6.4%
75 to 79 years	3.5%	3.6%	3.2%	2.9%	6.7%
80 to 84 years	2.3%	3.2%	2.1%	2.8%	3.3%
85+ years	2.6%	3.7%	2.3%	3.5%	2.6%
0-19 years	21.1%	20.5%	21.7%	22.5%	17.3%
65+ years	20.6%	24.1%	18.5%	22.9%	28.0%
Median age 2006-10 (years, weighted by population)	42.0	44.4	39.4	45.3	48.6
Median age 2016-20 (years, weighted by population)	44.8	48.0	42.2	46.3	54.3
Change from 2006-10 to 2016-20 (years)	+2.8	+3.6	+2.8	+1.0	+5.7
<b>RACE/ETHNICITY<sup>32</sup></b>					
White alone, not Hispanic or Latino	90.2%	92.6%	90.9%	91.4%	94.2%
Black alone, not Hispanic or Latino	1.8%	0.6%	0.9%	0.4%	0.3%
Hispanic or Latino	2.0%	1.4%	1.8%	1.4%	1.0%
American Indian or Alaska Native	0.5%	1.8%	0.9%	3.3%	0.4%
Asian	1.2%	0.6%	1.2%	0.4%	0.3%
Native Hawaiian and Other Pacific Islander	0.0%	0.0%	0.0%	0.0%	0.0%
One other race	0.3%	0.2%	0.3%	0.1%	0.1%
<b>HOUSEHOLDS<sup>33</sup></b>					

	Maine	Aroostook County	Penobscot County	Houlton LMA	Millinocket LMA
Total households	569,551	29,594	63,073	7,502	4,698
Average household size (weighted by number of households)	2.3	2.2	2.3	2.3	2.1
<b>FAMILIES<sup>34</sup></b>					
Total families	349,955	18,198	38,100	4,671	2,920
Average family size (weighted by number of families)	2.82	2.77	2.82	2.93	2.55
Married family households	275,146	14,380	29,173	3,670	2,417
Married families with individuals under 18	33.9%	30.9%	34.7%	33.6%	24.6%
Married families with individual age 60+	45.7%	48.5%	41.5%	44.6%	49.4%
Male householder, no spouse present	6.8%	7.7%	7.1%	6.7%	5.9%
Male householder, no spouse present, with children	3.8%	4.3%	3.9%	3.4%	3.9%
Female householder, no spouse present	14.6%	13.3%	16.3%	14.7%	11.3%
Female householder, no spouse present, with children	8.1%	6.5%	9.0%	7.2%	8.5%
<b>HOUSEHOLD INCOME<sup>35</sup></b>					
Percentage of households with incomes (weighted by number of households)					
Less than \$10,000	5.3%	7.6%	5.9%	9.3%	4.7%
\$10,000 to \$14,999	4.9%	8.6%	5.4%	6.6%	6.5%
\$15,000 to \$24,999	9.7%	13.6%	11.9%	14.6%	16.2%
\$25,000 to \$34,999	9.3%	11.3%	11.0%	12.8%	14.6%
\$35,000 to \$49,999	13.1%	14.8%	14.3%	12.8%	18.8%
\$50,000 to \$74,999	18.5%	18.0%	18.4%	18.1%	16.6%
\$75,000 to \$99,999	13.8%	11.6%	12.5%	10.4%	11.7%
\$100,000 to \$149,999	15.0%	9.3%	12.8%	10.5%	8.4%
\$150,000 to \$199,999	5.5%	2.8%	4.5%	2.2%	1.5%

	Maine	Aroostook County	Penobscot County	Houlton LMA	Millinocket LMA
\$200,000 or more	4.9%	2.5%	3.4%	2.7%	1.2%
Median household income (\$)	\$59,489	\$43,791	\$52,128	\$43,740	\$41,847
<b>POVERTY RATE</b>					
Individuals in households with incomes below poverty level (weighted by population)					
Total population (2016-20) <sup>36</sup>	11.1%	14.3%	13.4%	18.1%	13.7%
0-4 years	15.4%	19.8%	17.7%	28.8%	34.8%
5-17 years	13.5%	16.9%	15.4%	25.1%	18.3%
18-34 years	14.8%	15.5%	20.6%	19.3%	13.8%
35-64 years	9.3%	12.9%	10.8%	15.3%	14.9%
65+ years	8.5%	13.2%	8.0%	15.1%	7.3%
Total population (2006-10) <sup>37</sup>	12.6%	15.4%	15.7%	17.0%	11.6%
0-4 years	21.8%	24.3%	25.9%	34.5%	17.1%
5-17 years	15.4%	19.2%	18.5%	21.4%	15.7%
18-34 years	17.9%	22.6%	25.8%	21.8%	17.0%
35-64 years	9.3%	11.8%	10.4%	13.9%	9.9%
65+ years	9.6%	11.7%	9.2%	11.7%	8.3%
Change 2006-10 to 2016-20 (percentage point)					
Total population	-1.5%	-1.1%	-2.3%	+1.1%	+2.1%
0-4 years	-6.4%	-4.5%	-8.2%	-5.7%	+17.7%
5-17 years	-1.9%	-2.3%	-3.1%	+3.7%	+2.6%
18-34 years	-3.1%	-7.1%	-5.2%	-2.5%	-3.2%
35-64 years	+0.0%	+1.1%	+0.4%	+1.4%	+5.0%
65+ years	-1.1%	+1.5%	-1.2%	+3.4%	-1.0%

## Appendix B: Labor Force

	Maine	Aroostook County	Penobscot County	Houlton LMA	Millinocket LMA
<b>EMPLOYMENT</b>					
Labor force <sup>38</sup>	681,884	29,056	74,855	7,328	3,281
Employment <sup>39</sup>	650,334	27,408	71,312	6,876	3,033
Unemployment <sup>40</sup>	31,550	1,648	3,543	452	248
Unemployment rate <sup>41</sup>	4.6%	5.7%	5.7%	6.2%	7.6%
Labor force participation rate 2016-20 <sup>42</sup> (weighted by population age 16+)	63.0%	54.1%	60.9%	52.6%	49.4%
Labor force participation rate 2011-15 <sup>43</sup> (weighted by population age 16+)	63.6%	56.7%	61.1%	55.5%	49.9%
Change 2011-15 to 2016-20 (percentage points)	-0.6%	-2.6%	-0.2%	-2.9%	-0.5%
Population age 16+ (2016-20) <sup>44</sup>	1,120,778	56,773	127,672	14,916	8,425
Population age 16+ in labor force	706,090	30,714	77,752	7,851	4,165
Population age 16+ in labor force if participation matched state		35,767	80,433	9,397	5,308
Difference		+5,053	+2,681	+1,546	+1,143
Labor force participation by age 2016-2020					
16-19 years	50.9%	43.9%	42.1%	46.9%	19.1%
20-24 years	80.4%	76.0%	73.9%	78.9%	68.6%
25-29 years	84.1%	82.3%	84.4%	71.8%	87.8%
30-34 years	85.0%	79.1%	81.5%	78.6%	73.2%
35-44 years	84.7%	79.9%	83.2%	75.1%	88.2%
45-54 years	82.9%	76.6%	79.2%	73.9%	76.2%
55-59 years	74.6%	68.4%	69.8%	63.4%	64.4%
60-64 years	60.9%	49.3%	56.7%	47.1%	39.0%
65-74 years	28.8%	20.6%	25.5%	23.6%	16.6%
75+ years	6.7%	3.4%	5.4%	4.0%	5.6%



	Maine	Aroostook County	Penobscot County	Houlton LMA	Millinocket LMA
<b>SEASONALITY</b>					
Employment (2021) <sup>45</sup>					
January	634,359	27,221	69,518	6,778	2,918
February	638,271	27,581	70,609	6,838	2,962
March	640,976	27,596	71,005	6,852	2,964
April	643,034	27,055	71,017	6,718	2,936
May	645,240	27,372	70,105	6,857	3,026
June	655,937	27,756	70,476	7,017	3,137
July	668,843	28,191	71,278	7,169	3,209
August	667,385	27,936	71,147	7,105	3,205
September	655,157	27,000	72,258	6,805	3,019
October	656,386	27,201	73,123	6,815	3,043
November	649,082	26,920	72,789	6,743	2,974
December	649,342	27,066	72,416	6,819	3,001
Ratio peak/trough month employment	95%	98%	98%	95%	92%
Unemployment Rate (2021) <sup>46</sup>					
January	5.5%	6.0%	5.5%	6.2%	8.0%
February	5.5%	5.9%	5.3%	6.1%	8.2%
March	5.4%	6.0%	5.3%	6.3%	8.5%
April	5.3%	7.0%	5.4%	8.0%	9.0%
May	5.0%	6.6%	5.1%	7.4%	8.3%
June	5.1%	6.5%	5.4%	7.1%	8.2%
July	4.6%	5.6%	5.0%	5.9%	7.7%
August	4.2%	5.2%	4.6%	5.6%	6.9%
September	3.8%	5.0%	3.9%	5.7%	6.5%
October	3.7%	4.6%	3.9%	5.2%	6.1%
November	3.8%	4.9%	3.9%	5.5%	6.9%

	Maine	Aroostook County	Penobscot County	Houlton LMA	Millinocket LMA
December	3.5%	4.6%	3.6%	4.9%	6.3%
Ratio peak/trough unemployment	125%	110%	113%	107%	111%
<b>EDUCATIONAL ATTAINMENT<sup>47</sup></b>					
Population age 25+					
Total	982,385	50,068	108,311	13,048	7,865
Less than 9 <sup>th</sup> grade	2.3%	4.2%	2.3%	3.9%	1.6%
9-12 grade, no diploma	4.5%	6.0%	4.9%	7.0%	6.3%
High school diploma or equivalent	31.3%	37.2%	33.4%	41.8%	42.7%
Some college, no degree	19.2%	20.9%	19.9%	20.0%	23.9%
Associate's degree	10.2%	12.0%	10.9%	10.1%	12.8%
Bachelor's degree	20.3%	13.6%	17.7%	12.1%	9.1%
Graduate or professional degree	12.2%	6.1%	10.9%	5.1%	3.6%
Bachelor's degree or higher (above two categories combined)	32.5%	19.8%	28.6%	17.2%	12.7%
<b>AGE<sup>48</sup></b>					
Percentage of working-age population (25-64 years)					
25-34 years	16.4%	13.4%	18.6%	12.1%	12.2%
35-44 years	15.7%	14.0%	15.8%	15.2%	11.4%
45-64 years	39.8%	40.1%	39.7%	41.1%	41.3%
<b>OCCUPATIONS<sup>49</sup></b>					
Civilian employed population 16 years and over	675,784	29,147	73,848	7,342	3,808
Management, business, and financial	102,043	3,627	8,723	907	351
Computer, engineering, and science	33,219	599	2,993	117	56
Education, legal, community service, arts, and media	81,031	2,903	9,314	767	361
Healthcare practitioners and technical	45,866	1,894	5,941	396	257
Healthcare support	27,468	1,514	3,666	390	222
Protective service	11,423	716	1,333	229	97

	Maine	Aroostook County	Penobscot County	Houlton LMA	Millinocket LMA
Food preparation and serving related	36,787	1,479	4,535	376	197
Building and grounds cleaning and maintenance	24,385	1,003	2,771	229	227
Personal care and service	17,806	714	2,252	165	109
Sales and related	65,889	2,674	8,234	861	360
Office and administrative support	76,108	3,597	8,440	724	484
Farming, fishing, and forestry	10,166	994	571	210	74
Construction and extraction	40,034	1,805	4,315	431	339
Installation, maintenance, and repair	22,603	1,205	2,935	326	208
Production	35,486	1,726	2,651	384	141
Transportation	24,520	1,574	2,907	474	126
Material moving	20,950	1,123	2,267	356	199
Percentage of total					
Management, business, and financial	15%	12%	12%	12%	9%
Computer, engineering, and science	5%	2%	4%	2%	1%
Education, legal, community service, arts, and media	12%	10%	13%	10%	9%
Healthcare practitioners and technical	7%	6%	8%	5%	7%
Healthcare support	4%	5%	5%	5%	6%
Protective service	2%	2%	2%	3%	3%
Food preparation and serving related	5%	5%	6%	5%	5%
Building and grounds cleaning and maintenance	4%	3%	4%	3%	6%
Personal care and service	3%	2%	3%	2%	3%
Sales and related	10%	9%	11%	12%	9%
Office and administrative support	11%	12%	11%	10%	13%
Farming, fishing, and forestry	2%	3%	1%	3%	2%
Construction and extraction	6%	6%	6%	6%	9%
Installation, maintenance, and repair	3%	4%	4%	4%	5%
Production	5%	6%	4%	5%	4%
Transportation	4%	5%	4%	6%	3%

	Maine	Aroostook County	Penobscot County	Houlton LMA	Millinocket LMA
Material moving	3%	4%	3%	5%	5%
Ratio local/state occupation percentage					
Management, business, and financial	1.00	0.82	0.78	0.82	0.61
Computer, engineering, and science	1.00	0.42	0.82	0.32	0.30
Education, legal, community service, arts, and media	1.00	0.83	1.05	0.87	0.79
Healthcare practitioners and technical	1.00	0.96	1.19	0.79	0.99
Healthcare support	1.00	1.28	1.22	1.31	1.43
Protective service	1.00	1.45	1.07	1.85	1.51
Food preparation and serving related	1.00	0.93	1.13	0.94	0.95
Building and grounds cleaning and maintenance	1.00	0.95	1.04	0.86	1.65
Personal care and service	1.00	0.93	1.16	0.85	1.09
Sales and related	1.00	0.94	1.14	1.20	0.97
Office and administrative support	1.00	1.10	1.01	0.88	1.13
Farming, fishing, and forestry	1.00	2.27	0.51	1.90	1.29
Construction and extraction	1.00	1.05	0.99	0.99	1.50
Installation, maintenance, and repair	1.00	1.24	1.19	1.33	1.63
Production	1.00	1.13	0.68	1.00	0.71
Transportation	1.00	1.49	1.08	1.78	0.91
Material moving	1.00	1.24	0.99	1.56	1.69
<b>COMMUTING<sup>50</sup></b>					
Workers age 16+	662,547	28,743	72,067	7,161	3,729
Workers not working at home (number)	608,861	27,630	67,524	6,754	3,442
(percentage)	91.9%	96.1%	93.7%	94.3%	92.3%
Travel time to work (number)					
Less than 10 minutes	105,353	8,721	12,037	2,228	1,128
10 to 29 minutes	305,121	13,363	37,552	3,138	1,364

	Maine	Aroostook County	Penobscot County	Houlton LMA	Millinocket LMA
30 to 59 minutes	158,159	4,033	13,814	988	474
60 minutes or longer	40,228	1,513	4,121	400	476
Travel time to work (percentage)					
Less than 10 minutes	17.3%	31.6%	17.8%	33.0%	32.8%
10 to 29 minutes	50.1%	48.4%	55.6%	46.5%	39.6%
30 to 59 minutes	26.0%	14.6%	20.5%	14.6%	13.8%
60 minutes or longer	6.6%	5.5%	6.1%	5.9%	13.8%



## Appendix C: Industries

	NAICS Code 51	Maine	Aroostook County	Penobscot County	Houlton LMA	Millinocket LMA
<b>ESTABLISHMENTS<sup>52</sup></b>						
Total, all industries	10	59,795	2032	4512	622	246
Agriculture, forestry, fishing and hunting	11	1,703	228	99	51	11
Mining, quarrying, and oil and gas extraction	21	37	--	--	--	--
Utilities	22	280		14	7	6
Construction	23	6,134	186	526	51	26
Manufacturing	31-33	1,885	80	151	20	6
Wholesale trade	42	3,054	80	210	18	5
Retail trade	44-45	6,010	307	645	74	36
Transportation and warehousing	48-49	1,879	160	188	65	20
Information	51	1,112	33	60	13	4
Finance and insurance	52	2,243	83	201	19	10
Real estate and rental and leasing	53	1,961	62	201	19	4
Professional and technical services	54	7,578	147	497	38	10
Management of companies and enterprises	55	1,782	26	96	10	--
Administrative and waste services	56	3,807	94	262	22	16
Educational services	61	1,392	18	49	14	7
Health care and social assistance	62	5,120	230	558	78	15
Arts, entertainment, and recreation	71	1,057	24	75	7	11
Accommodation and food services	72	4,340	138	338	40	27
Other services, except public administration	81	3,954	128	338	27	13
Public administration	92	1,179	--	--	47	14
Unclassified	99	3,288	--	--	--	--
Percentage of total						
Agriculture, forestry, fishing and hunting	11	2.8%	11.2%	2.2%	8.2%	4.5%

	NAICS Code 51	Maine	Aroostook County	Penobscot County	Houlton LMA	Millinocket LMA
Mining, quarrying, and oil and gas extraction	21	0.1%	--	--	--	--
Utilities	22	0.5%	0.0%	0.3%	1.1%	2.4%
Construction	23	10.3%	9.2%	11.7%	8.2%	10.6%
Manufacturing	31-33	3.2%	3.9%	3.3%	3.2%	2.4%
Wholesale trade	42	5.1%	3.9%	4.7%	2.9%	2.0%
Retail trade	44-45	10.1%	15.1%	14.3%	11.9%	14.6%
Transportation and warehousing	48-49	3.1%	7.9%	4.2%	10.5%	8.1%
Information	51	1.9%	1.6%	1.3%	2.1%	1.6%
Finance and insurance	52	3.8%	4.1%	4.5%	3.1%	4.1%
Real estate and rental and leasing	53	3.3%	3.1%	4.5%	3.1%	1.6%
Professional and technical services	54	12.7%	7.2%	11.0%	6.1%	4.1%
Management of companies and enterprises	55	3.0%	1.3%	2.1%	1.6%	--
Administrative and waste services	56	6.4%	4.6%	5.8%	3.5%	6.5%
Educational services	61	2.3%	0.9%	1.1%	2.3%	2.8%
Health care and social assistance	62	8.6%	11.3%	12.4%	12.5%	6.1%
Arts, entertainment, and recreation	71	1.8%	1.2%	1.7%	1.1%	4.5%
Accommodation and food services	72	7.3%	6.8%	7.5%	6.4%	11.0%
Other services, except public administration	81	6.6%	6.3%	7.5%	4.3%	5.3%
Public administration	92	2.0%	--	--	7.6%	5.7%
Unclassified	99	5.5%	--	--	--	--
Goods-producing establishments	101					
2001		8,699	547	738	150	54
2011		8,622	527	714	134	41
2021		9,759	494	779	124	43
Change 2001 to 2021 (number)		+1,060	-53	+41	-26	-11
(percentage)		+12.2%	-9.7%	+5.6%	-17.3%	-20.4%

	NAICS Code 51	Maine	Aroostook County	Penobscot County	Houlton LMA	Millinocket LMA
Service-providing establishments	102					
2001		37,874	2,041	3,642	564	249
2011		40,510	1,895	3,810	491	203
2021		50,036	1,538	3,733	498	203
Change 2001 to 2021 (number)		+12,162	-503	+91	-66	-46
(percentage)		+32.1%	-24.6%	+2.5%	-11.7%	-18.5%
Ratio goods-producing /service-providing						
2001		0.23	0.27	0.20	0.27	0.22
2011		0.21	0.28	0.19	0.27	0.20
2021		0.20	0.32	0.21	0.25	0.21
<b>EMPLOYMENT (annual average)<sup>53</sup></b>						
Total, all industries	10	609,907	19,728	56,441	5,893	1,974
Agriculture, forestry, fishing and hunting	11	8,400	1,436	717	275	33
Mining, quarrying, and oil and gas extraction	21	241	--	--	--	--
Utilities	22	2,935	--	312	36	41
Construction	23	34,213	827	3,424	238	65
Manufacturing	31-33	60,220	2,659	2,672	500	104
Wholesale trade	42	19,081	504	2,186	89	24
Retail trade	44-45	79,400	3,674	10,194	952	343
Transportation and warehousing	48-49	20,751	907	2,617	272	81
Information	51	7,126	251	722	59	13
Finance and insurance	52	23,335	794	1,420	135	76
Real estate and rental and leasing	53	7,412	243	742	45	8
Professional and technical services	54	30,508	416	2,066	62	16
Management of companies and enterprises	55	14,707	243	2,894	80	--
Administrative and waste services	56	28,797	415	2,752	126	23

	NAICS Code 51	Maine	Aroostook County	Penobscot County	Houlton LMA	Millinocket LMA
Educational services	61	56,760	218	1,043	634	234
Health care and social assistance	62	108,342	4,890	14,889	1,333	454
Arts, entertainment, and recreation	71	9,922	113	821	52	118
Accommodation and food services	72	52,031	1,545	5,240	396	198
Other services, except public administration	81	16,755	467	1,726	100	50
Public administration	92	27,150	--	--	511	55
Unclassified	99	1,822	--	--	--	--
Goods-producing	101	103,075	4,921	6,816	1,014	203
Service-providing	102	506,832	14,807	49,625	4,879	1,772
Percentage of total annual average						
Agriculture, forestry, fishing and hunting	11	1.4%	7.3%	1.3%	4.7%	1.7%
Mining, quarrying, and oil and gas extraction	21	0.0%	--	--	--	--
Utilities	22	0.5%	--	0.6%	0.6%	2.1%
Construction	23	5.6%	4.2%	6.1%	4.0%	3.3%
Manufacturing	31-33	9.9%	13.5%	4.7%	8.5%	5.3%
Wholesale trade	42	3.1%	2.6%	3.9%	1.5%	1.2%
Retail trade	44-45	13.0%	18.6%	18.1%	16.2%	17.4%
Transportation and warehousing	48-49	3.4%	4.6%	4.6%	4.6%	4.1%
Information	51	1.2%	1.3%	1.3%	1.0%	0.7%
Finance and insurance	52	3.8%	4.0%	2.5%	2.3%	3.9%
Real estate and rental and leasing	53	1.2%	1.2%	1.3%	0.8%	0.4%
Professional and technical services	54	5.0%	2.1%	3.7%	1.1%	0.8%
Management of companies and enterprises	55	2.4%	1.2%	5.1%	1.4%	--
Administrative and waste services	56	4.7%	2.1%	4.9%	2.1%	1.2%
Educational services	61	9.3%	1.1%	1.8%	10.8%	11.9%
Health care and social assistance	62	17.8%	24.8%	26.4%	22.6%	23.0%

	NAICS Code 51	Maine	Aroostook County	Penobscot County	Houlton LMA	Millinocket LMA
Arts, entertainment, and recreation	71	1.6%	0.6%	1.5%	0.9%	6.0%
Accommodation and food services	72	8.5%	7.8%	9.3%	6.7%	10.0%
Other services, except public administration	81	2.7%	2.4%	3.1%	1.7%	2.5%
Public administration	92	4.5%	--	--	8.7%	2.8%
Unclassified	99	0.3%	--	--	--	--
Goods-producing	101	16.9%	24.9%	12.1%	17.2%	10.3%
Service-providing	102	83.1%	75.1%	87.9%	82.8%	89.8%
Ratio local/state employment percentage						
Agriculture, forestry, fishing and hunting		1.00	5.29	0.92	3.39	1.21
Mining, quarrying, and oil and gas extraction		1.00	--	--	--	--
Utilities		1.00	--	1.15	1.27	4.32
Construction		1.00	0.75	1.08	0.72	0.59
Manufacturing		1.00	1.37	0.48	0.86	0.53
Wholesale trade		1.00	0.82	1.24	0.48	0.39
Retail trade		1.00	1.43	1.39	1.24	1.33
Transportation and warehousing		1.00	1.35	1.36	1.36	1.21
Information		1.00	1.09	1.09	0.86	0.56
Finance and insurance		1.00	1.05	0.66	0.60	1.01
Real estate and rental and leasing		1.00	1.01	1.08	0.63	0.33
Professional and technical services		1.00	0.42	0.73	0.21	0.16
Management of companies and enterprises		1.00	0.51	2.13	0.56	--
Administrative and waste services		1.00	0.45	1.03	0.45	0.25
Educational services		1.00	0.12	0.20	1.16	1.27
Health care and social assistance		1.00	1.40	1.49	1.27	1.29
Arts, entertainment, and recreation		1.00	0.35	0.89	0.54	3.67
Accommodation and food services		1.00	0.92	1.09	0.79	1.18



	NAICS Code 51	Maine	Aroostook County	Penobscot County	Houlton LMA	Millinocket LMA
Other services, except public administration		1.00	0.86	1.11	0.62	0.92
Public administration		1.00	--	--	1.95	0.63
Unclassified		1.00	--	--	--	--
Employment at goods-producing establishments	101					
2001 <sup>54</sup>		116,840	6,497	10,982	1,326	1,378
2011		89,308	5,228	7,318	995	427
2021		103,075	4,921	6,816	1,014	203
Change 2001 to 2021 (number)		-13,765	-1,576	-4,166	-312	-1,175
(percentage)		-11.8%	-24.3%	-37.9%	-23.5%	-85.3%
Employment at service-providing establishments	102					
2001		476,195	23,371	58,935	4,947	2,660
2011		490,571	22,990	60,954	5089	2,055
2021		506,832	14,807	49,625	4,879	1,772
Change 2001 to 2021 (number)		+30,637	-8,564	-9,310	-68	-888
(percentage)		+6.4%	-36.6%	-15.8%	-1.4%	-33.4%
Ratio goods-producing /service-providing						
2001		0.25	0.28	0.19	0.27	0.52
2011		0.18	0.23	0.12	0.20	0.21
2021		0.20	0.33	0.14	0.21	0.11
Percentage of employment at goods-producing establishments						
2001		19.7%	21.8%	15.7%	21.1%	34.1%
2011		15.4%	18.5%	10.7%	16.4%	17.2%
2021		16.9%	24.9%	12.1%	17.2%	10.3%

	NAICS Code 51	Maine	Aroostook County	Penobscot County	Houlton LMA	Millinocket LMA
Average employees per establishment						
2001		12.73	11.54	15.96	8.79	13.33
2011		11.80	11.65	15.09	9.73	10.17
2021		10.20	9.71	12.51	9.47	8.03
<b>WAGES (average weekly, \$)<sup>55</sup></b>						
Total, all industries	10	\$1,051	\$836	\$951	\$798	\$720
Agriculture, forestry, fishing and hunting	11	\$803	\$719	\$918	\$651	\$810
Mining, quarrying, and oil and gas extraction	21	\$1,180	--	--	--	--
Utilities	22	\$1,501	--	\$1,825	\$1,468	\$1,470
Construction	23	\$1,109	\$906	\$1,134	\$989	\$840
Manufacturing	31-33	\$1,241	\$1,069	\$1,047	\$915	\$833
Wholesale trade	42	\$1,546	\$1,189	\$1,192	\$897	\$1,231
Retail trade	44-45	\$684	\$604	\$666	\$603	\$502
Transportation and warehousing	48-49	\$995	\$862	\$948	\$811	\$785
Information	51	\$1,299	\$851	\$1,051	\$885	\$723
Finance and insurance	52	\$1,760	\$1,160	\$1,470	\$1,018	\$778
Real estate and rental and leasing	53	\$996	\$691	\$858	\$566	\$618
Professional and technical services	54	\$1,640	\$1,113	\$1,238	\$906	\$1,469
Management of companies and enterprises	55	\$1,878	\$1,096	\$1,426	\$1,317	--
Administrative and waste services	56	\$869	\$637	\$649	\$814	\$306
Educational services	61	\$929	\$709	\$795	\$733	\$635
Health care and social assistance	62	\$1,091	\$961	\$1,157	\$821	\$960
Arts, entertainment, and recreation	71	\$589	\$361	\$362	\$339	\$583
Accommodation and food services	72	\$538	\$382	\$453	\$351	\$333
Other services, except public administration	81	\$794	\$632	\$703	\$610	\$472
Public administration	92	\$1,144	--	--	\$1,265	\$614

	NAICS Code 51	Maine	Aroostook County	Penobscot County	Houlton LMA	Millinocket LMA
Unclassified	99	\$1,614	--	--	--	--
Goods-producing	101	\$1,161	\$940	\$1,077	\$862	\$831
Service-providing	102	\$1,029	\$801	\$934	\$784	\$708
Ratio local/state average weekly wage						
Total, all industries	10	1.00	0.80	0.90	0.76	0.69
Agriculture, forestry, fishing and hunting	11	1.00	0.90	1.14	0.81	1.01
Mining, quarrying, and oil and gas extraction	21	1.00	--	--	--	--
Utilities	22	1.00	--	1.22	0.98	0.98
Construction	23	1.00	0.82	1.02	0.89	0.76
Manufacturing	31-33	1.00	0.86	0.84	0.74	0.67
Wholesale trade	42	1.00	0.77	0.77	0.58	0.80
Retail trade	44-45	1.00	0.88	0.97	0.88	0.73
Transportation and warehousing	48-49	1.00	0.87	0.95	0.82	0.79
Information	51	1.00	0.66	0.81	0.68	0.56
Finance and insurance	52	1.00	0.66	0.84	0.58	0.44
Real estate and rental and leasing	53	1.00	0.69	0.86	0.57	0.62
Professional and technical services	54	1.00	0.68	0.75	0.55	0.90
Management of companies and enterprises	55	1.00	0.58	0.76	0.70	--
Administrative and waste services	56	1.00	0.73	0.75	0.94	0.35
Educational services	61	1.00	0.76	0.86	0.79	0.68
Health care and social assistance	62	1.00	0.88	1.06	0.75	0.88
Arts, entertainment, and recreation	71	1.00	0.61	0.61	0.58	0.99
Accommodation and food services	72	1.00	0.71	0.84	0.65	0.62
Other services, except public administration	81	1.00	0.80	0.89	0.77	0.59
Public administration	92	1.00	--	--	1.11	0.54
Unclassified	99	1.00	--	--	--	--

	NAICS Code 51	Maine	Aroostook County	Penobscot County	Houlton LMA	Millinocket LMA
Goods-producing	101					
2001		1.00	0.86	0.98	0.70	1.10
2011		1.00	0.77	0.89	0.68	0.99
2021		1.00	0.81	0.93	0.74	0.72
Service-providing	102					
2001		1.00	0.81	0.98	0.75	0.94
2011		1.00	0.85	0.95	0.81	0.74
2021		1.00	0.78	0.91	0.76	0.69
Ratio goods-producing/service-providing average weekly wage						
2001		1.29	1.37	1.31	1.21	1.52
2011		1.31	1.19	1.23	1.10	1.76
2021		1.13	1.17	1.15	1.10	1.17
Weekly Living Wage, 2020 (\$)56						
1 adult, 0 children		\$715	\$624	\$664	--	--
1 adult, 1 child		\$1,392	\$1,216	\$1,329	--	--
1 adult, 2 children		\$1,735	\$1,492	\$1,662	--	--
2 adults (both working), 0 children		\$478	\$458	\$464	--	--
2 adults (both working), 1 child		\$766	\$678	\$734	--	--
2 adults (both working), 2 children		\$991	\$869	\$955	--	--

“—” indicates no data disclosed or calculated for this industry in this geography.

	Employer	Employment Range	Employer	Employment Range
<b>LARGEST EMPLOYERS<sup>57</sup></b>				
Top 25 employers by average monthly employment, 2021	Northern Light AR Gould Hospital	501 to 1,000	Northern Light Eastern Maine Medical Center	3,501 to 4,000
	Northern Maine Medical Center	501 to 1,000	Northern Light Health	1,501 to 2,000
	Wal Mart / Sam's Club	501 to 1,000	Hannaford Bros Co	1,001 to 1,500
	Twin Rivers Paper Company LLC	1 to 500	Wal Mart / Sam's Club	1,001 to 1,500
	McCain Foods USA Inc	1 to 500	St Joseph Hospital Inc	501 to 1,000
	Houlton Regional Hospital	1 to 500	Penobscot Community Health Care	501 to 1,000
	Caribou Nursing Home Inc	1 to 500	Bangor Savings Bank	501 to 1,000
	Maine Mutual Fire Insurance Co	1 to 500	Husson University	501 to 1,000
	Aroostook Mental Health Services Inc	1 to 500	Northern Light Acadia Hospital	501 to 1,000
	Aroostook County Action	1 to 500	UPS Solutions	1 to 500
	Hannaford Bros Co	1 to 500	Penquis C.A.P., Inc.	1 to 500
	Pineland Farms Potato Company	1 to 500	Production Services Of Maine LLC	1 to 500
	Maple Grove Nursing Home Inc	1 to 500	Lowes Home Centers LLC	1 to 500
	Community Living Association	1 to 500	Versant Power	1 to 500
	Louisiana Pacific Corporation	1 to 500	Sargent Corporation	1 to 500
	McDonalds	1 to 500	Dysarts Service Inc	1 to 500
	Columbia Forest Products Inc	1 to 500	Community Health and Counseling Svc	1 to 500
	Huber Engineered Woods LLC	1 to 500	Darlings	1 to 500
	Aroostook Home Health Services	1 to 500	General Electric Co	1 to 500
	Daigle Oil Company	1 to 500	Ohi	1 to 500
	Katahdin Trust Co	1 to 500	Wayfair Maine LLC	1 to 500
	Lowes Home Centers LLC	1 to 500	Target Corporation	1 to 500
	Smith & Wesson Inc	1 to 500	Northern Light Laboratory	1 to 500
	Pines Health Services Inc	1 to 500	HC Bangor LLC	1 to 500
Paradis Shop 'N Save	1 to 500	Millinocket Regional Hospital	1 to 500	



	Maine	Houlton ESA <sup>58</sup>	Millinocket ESA <sup>59</sup>	Patten ESA <sup>60</sup>
<b>RETAIL SALES<sup>61</sup></b>				
Total taxable retail sales, 2021 (\$ thousand)	\$32,474,400	\$180,696	\$60,864	\$38,219
Percentage of sales to consumers	89%	93%	92%	--
Percentage of sales to businesses	11%	7%	8%	--
Total taxable retail sales, 2010 (\$ thousand)	\$16,446,734	\$131,119	\$45,961	\$25,577
Change 2010 to 2021, not adjusted for inflation	\$16,027,666	\$49,577	\$14,903	\$12,642
(percentages)	97%	38%	32%	49%
Inflation, 2010-2021 (CPI-U, nationwide)	24%			
Taxable retail sales at restaurants and lodging establishments				
2010 (\$ thousand)	\$2,672,972	\$13,248	\$9,823	\$3,403
(percentages)	16.3%	10.1%	21.4%	13.3%
2021 (\$ thousand)	\$4,766,321	\$18,104	\$13,762	\$4,402
(percentages)	14.7%	10.0%	22.6%	11.5%
Change, 2010-21	78.3%	36.7%	40.1%	29.4%

“—” indicates no data disclosed for this sales category in this geography.

	Maine	Maine Highlands <sup>62</sup>	
		Value	Percentage of state*
<b>TOURISM<sup>63</sup></b>			
Estimated annual visitors	15,601,800	907,200	5.8%
Day visitors	4,368,500	226,800	5.2%
Overnight visitors	11,233,300	680,400	6.1%
Estimated visitor spending (\$)			
Total	\$7,853,094,700	\$538,820,900	6.9%
Lodging	\$1,874,899,800	\$128,641,668	6.9%
Restaurants/food	\$2,328,295,600	\$159,750,312	6.9%
Retail sales	\$1,404,976,300	\$96,399,015	6.9%
Recreation	\$908,595,300	\$62,341,046	6.9%
Gasoline	\$982,932,100	\$67,441,484	6.9%
Other transportation	\$353,395,600	\$24,247,375	6.9%
Estimated economic impact			
Jobs	143,100	9,400	6.6%
Earnings (\$)	\$5,050,181,600	\$296,048,200	5.9%
Tax revenue (\$)	\$1,147,884,700	\$75,152,700	6.5%

\*Note that as data was available in aggregate only for the estimated visitor spending in the Maine Highlands, the breakout of \$538.8 million total spending by categories was done with proportional analysis. As a result, the Maine Highlands' percentage of state estimated visitor spending is 6.9% across all categories.

## Appendix D: Housing

	Maine	Aroostook County	Penobscot County	Houlton LMA	Millinocket LMA
<b>AGE OF HOUSING STOCK<sup>64</sup></b>					
Total	746,793	40,007	76,088	11,140	7,991
1939 or earlier	177,985	8,580	16,547	2,550	1,130
1940-49	34,280	2,946	2,331	546	372
1950-59	53,704	4,551	6,104	916	1,316
1960-69	51,460	3,389	6,443	781	1,157
1970-79	103,247	6,741	10,803	1,737	1,644
1980-89	107,106	4,672	10,833	1,324	1,001
1990-99	91,258	4,310	9,115	1,466	544
2000-09	94,235	3,675	10,268	1,257	693
2010-13	17,456	758	1,930	354	92
2014 or later	16,062	385	1,714	209	42
Percentage of total					
1939 or earlier	24%	21%	22%	23%	14%
1940-49	5%	7%	3%	5%	5%
1950-59	7%	11%	8%	8%	16%
1960-69	7%	8%	8%	7%	14%
1970-79	14%	17%	14%	16%	21%
1980-89	14%	12%	14%	12%	13%
1990-99	12%	11%	12%	13%	7%
2000-09	13%	9%	13%	11%	9%
2010-13	2%	2%	3%	3%	1%
2014 or later	2%	1%	2%	2%	1%
Before 1950	28%	29%	25%	28%	19%
1950-1990	42%	48%	45%	43%	64%
Since 1990	29%	23%	30%	29%	17%

	Maine	Aroostook County	Penobscot County	Houlton LMA	Millinocket LMA
<b>OCCUPANCY<sup>65</sup></b>					
Total housing units	746,793	40,007	76,088	11,140	7,991
Occupied housing units	569,551	29,594	63,073	7,502	4,698
Vacant housing units	177,242	10,413	13,015	3,638	3,293
Occupancy rate	76.3%	74.0%	82.9%	67.3%	58.8%
Vacancy rate	23.7%	26.0%	17.1%	32.7%	41.2%
<b>HOMEOWNERSHIP<sup>66</sup></b>					
2021					
Median home price (\$)	\$295,000	\$122,000	\$200,000	\$115,000	\$109,000
Median income (\$)	\$63,427	\$42,713	\$52,150	\$40,779	\$41,103
Income needed to afford median home price (\$)	\$79,201	\$34,383	\$55,594	\$32,548	\$30,647
Household able to afford median home	38.4%	58.8%	47.1%	59.6%	62.0%
Households unable to afford median home	61.6%	41.2%	52.9%	40.4%	38.0%
2010					
Median home price (\$)	\$165,000	\$82,250	\$125,000	\$71,150	\$47,000
Median income (\$)	\$48,405	\$36,429	\$43,337	\$34,070	\$35,157
Income needed to afford median home price (\$)	\$55,282	\$28,547	\$42,469	\$24,830	\$16,153
Household able to afford median home	42.5%	60.3%	50.6%	62.6%	78.2%
Households unable to afford median home	57.5%	39.7%	49.4%	37.4%	21.8%
<b>RENTALS<sup>67</sup></b>					
2020				<i>(2017)<sup>68</sup></i>	
Median 2-bedroom rent (\$)	\$1,088	\$846	\$1,017	\$617	\$703
Renter household median income (\$)	\$38,231	\$29,261	\$33,675	\$24,333	\$27,465
Income needed to afford 2-bedroom rent (\$)	\$43,517	\$33,858	\$40,694	\$24,696	\$28,131
Households able to afford median 2-bedroom rent	45.0%	44.1%	43.0%	49.2%	48.9%

	Maine	Aroostook County	Penobscot County	Houlton LMA	Millinocket LMA
Households unable to afford median 2-bedroom rent	55.0%	55.9%	57.0%	50.8%	51.1%
2010					
Average 2-bedroom rent (\$)	\$814	\$657	\$818	\$618	\$548
Renter household median income (\$)	\$30,571	\$24,262	\$27,470	\$22,604	\$21,085
Income needed to afford 2-bedroom rent (\$)	\$32,560	\$26,275	\$32,710	\$24,720	\$21,921
Households able to afford average 2-bedroom rent	47.0%	46.8%	42.1%	46.0%	48.2%
Households unable to afford average 2-bedroom rent	53.0%	53.2%	57.9%	54.0%	51.8%

WORKING DRAFT - NOT FOR DISTRIBUTION



## Appendix E: Public Health

	Maine	Aroostook County	Penobscot County	Houlton LMA	Millinocket LMA
<b>HEALTH INSURANCE<sup>69</sup></b>					
Total civilian noninstitutionalized population	1,325,025	66,151	149,991	17,696	9,776
Insured	92.4%	91.6%	91.7%	88.2%	92.4%
Uninsured	7.6%	8.4%	8.3%	11.8%	7.6%
<b>HEALTH RISK FACTORS<sup>70</sup></b>					
Percentage of adults who are current smokers	19%	22%	20%	--	--
Percentage of adults who are obese	31%	38%	35%	--	--
<b>HEALTH CONDITIONS (age adjusted per 100,000 population)</b>					
Cancer rates (See right for year) <sup>71</sup>	<i>2016-2018</i>	<i>2016-2018</i>	<i>2016-2018</i>		
All cancers	473.2	460.2	525.2*	--	--
		<i>2015-2017</i>	<i>2015-2017</i>		
Brain and other nervous system tumors	Not Avail.	14.0	14.4	--	--
Colon and rectum cancer	36.5	48.6*	39.0	--	--
Female breast cancer	126.8	124.8	123.3	--	--
Lung and bronchus cancer	71.1	77.8	79.8	--	--
Prostate cancer	90.4	83.1	109.7*	--	--
Tobacco-related cancers	Not Avail.	142.9	143.8	--	--
Urinary bladder cancer	26.7	26.0	27.4	--	--
<b>Cancer rates 2008-10<sup>72</sup></b>					
All cancers	496.6	476.7	529.7*	--	--
Brain and other nervous system tumors	15.3	15.1	17.8	--	--
Colon and rectum cancer	43.1	52.5	46.7	--	--
Female breast cancer	124.5	98.9	131.8	--	--
Lung and bronchus cancer	76.2	84.1	92.2*	--	--
Prostate cancer	129.3	106.4	129.5	--	--

	Maine	Aroostook County	Penobscot County	Houlton LMA	Millinocket LMA
Tobacco-related cancers	90.5	92.8	91.5	--	--
Urinary bladder cancer	27.5	--	--	--	--
<b>Change in cancer rates <u>2008-10</u> to <u>2016-2018</u> or <u>2015-2017</u></b>	<b>2016-2018</b>	<b>2015-2017</b>	<b>2015-2017</b>		
All cancers	-4.7%	-3.5%	-0.8%	--	--
Brain and other nervous system tumors	--	-7.3%	-19.1%	--	--
Colon and rectum cancer	-19.3%	-7.4%	-16.5%	--	--
Female breast cancer	-0.2%	+26.2%	-6.4%	--	--
Lung and bronchus cancer	-9.3%	-7.5%	-13.4%	--	--
Prostate cancer	-24.1%	-21.9%	-15.3%	--	--
Tobacco-related cancers	--	+54.0%	+57.2%	--	--
Urinary bladder cancer	-8.4%	--	--	--	--
<b>Diabetes death rates<sup>73</sup></b>					
2006-10	21.30	22.90	23.70	--	--
2012-16	22.00	27.10	26.60	--	--
Change 2006-10 to 2012-16	+3.3%	+18.3%	+12.2%	--	--
<b>Coronary heart disease death rates<sup>74</sup></b>					
2006-10	102.1	122.3	116.2	--	--
2012-16	84.1	106.3	96.6	--	--
Change 2006-10 to 2012-16	-17.6%	-13.1%	-16.9%	--	--
<b>Stroke death rates<sup>75</sup></b>					
2006-10	38.6	39.2	43.3	--	--
2012-16	33.4	35.4	35.6	--	--
Change 2006-10 to 2012-16	-13.5%	-9.7%	-17.8%	--	--

\*Indicates the difference between the county and state rates is statistically significant.

# Appendix F: Labor Market Area Map

**MAINE**  
 DEPARTMENT OF  
**LABOR**  
 Center for Workforce  
 Research & Information

2015 - 2020

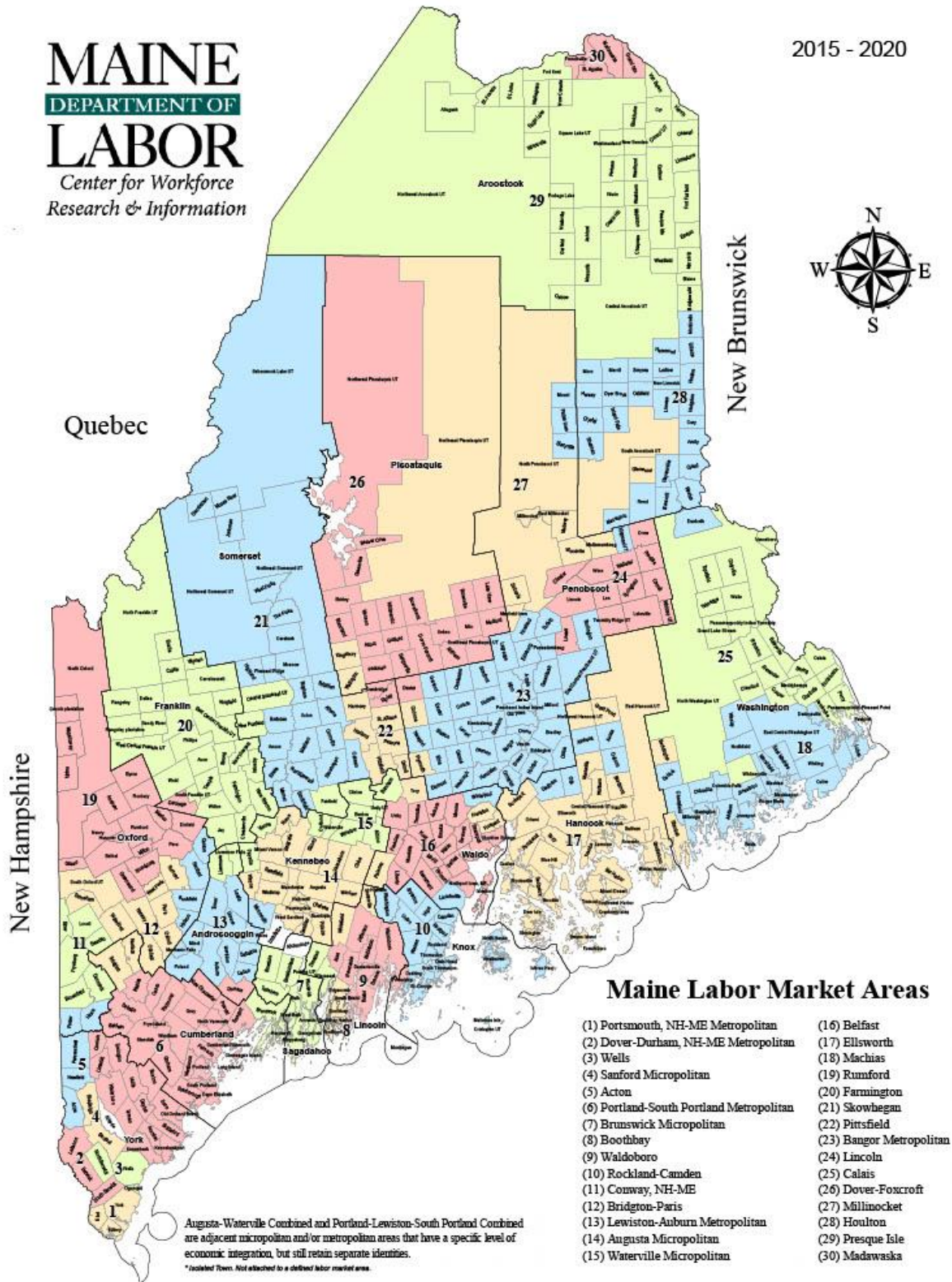

## Appendix G: RIMS II Multipliers

The Bureau of Economic Analysis Regional Input-Output Modeling System (RIMS II) provides multipliers for 406 detailed industries and 62 aggregate industries, defined by the North American Industry Classification System (NAICS). For this report we derived multipliers for the combined two-county economic region of Aroostook and Penobscot counties. To estimate the change in final demand generated by the Project to the region economy, one must first exclude the amount of spending that occurs outside of the region.

$$\text{Change in Final Demand} = \text{Total Spending} * (\% \text{ of Spending Within Economic Region})$$

The RIMS II multipliers are based on analyses of inter-industry linkages that track how revenues and expenditures in one industry relate to other industries and estimate the total change in economic activity across all industries in the region resulting from an initial change in economic activity from the project. For instance, the RIMS II output multiplier for construction in the economic region (Aroostook and Penobscot counties) is 1.59, meaning that a \$1 increase in final demand for construction services increases output across all industries in the region by \$1.59. The following equation summarizes that relationship.

$$\text{Change in Final Demand from Project} * \text{RIMS II Output Multiplier} = \text{Total Economic Impact for Output}$$

RIMS II jobs multipliers represent the number of part- and full-time jobs created across all industries from a \$1 million increase in final demand in one industry. For instance, the RIMS II jobs multiplier for construction in the economic region is 10.67. That means that a \$1 million increase in final demand for farm products increases employment in Cumberland County by the equivalent of 10.67 jobs.

$$\text{Change in Final Demand from Project}/\$1m * \text{RIMS II Jobs Multiplier} = \text{Total Economic Impact in Jobs}$$

More information can be found here: <https://www.bea.gov/resources/methodologies/RIMSII-user-guide>

## Appendix H: Economic Impact Methodology

The following steps were taken to derive the economic impact related to employment, earnings, output, and value-added.

1. First, Wolfden's estimated budget expenses were extracted from their financial model. The financial model includes more than a dozen linked spreadsheets and 150 separate budget line items with descriptions.
2. For each budget line item, Wolfden then estimated the portion of each expense line expected to be spent on materials and labor, and the portion expected to be purchased from businesses within the economic region. The regional percentage was estimated separately for materials and labor.
3. Purchases within the economic region for each budget line item were then derived by multiplying the total line item expense by the percentage expected to be purchased within the region, weighted by materials and labor.

*Regional Purchase by Line Item = Projected Expense by Line Item \* (% Materials \* % Materials Purchased in Region + % Labor \* % Labor Purchased in Region)*

4. Based on the descriptions of the expense, each line item expense was then mapped to the appropriate RIMS II industry and the corresponding multipliers. Line item expenses were then summarized by RIMS II industry.

*Regional Purchases by Industry = Sum of Regional Purchases by Line Item*

5. For several industries, while the purchase is expected to be made from a business within the economic region, the underlying commodity is not produced in Maine. For example, of the \$3 million projected to be spent on manufactured drill bits, \$1.5 million is expected to be purchased from regional businesses; but roughly \$1.1 million (77%) of that is estimated to be the value for production of the drill bits which happens outside of the region. Therefore, only \$0.4 million – the portion of spending that goes to transportation and wholesale margins for selling drill bits within the economic region – is included in the economic impact analysis below.

For these industries, national input-output tables<sup>76</sup> are used to exclude the production value of the purchase; that is, only the transportation, wholesale and retail trade margins are included. This has the effect of substantially reducing the economic impact within the region. These expenses were then mapped to the wholesale trade RIMS II multipliers.



<b>RIMS II Industry</b>	<b>% Excluded Production Value</b>	<b>% Included Transportation, Wholesale and Retail Margin</b>
<b>Machinery manufacturing</b>	77%	23%
<b>Fabricated metal product manufacturing</b>	88%	12%
<b>Plastics and rubber products manufacturing</b>	81%	19%
<b>Electrical equipment, appliance, and component manufacturing</b>	74%	26%
<b>Computer and electronic product manufacturing</b>	86%	14%
<b>Industrial gas manufacturing</b>	78%	22%

*Adjusted Regional Purchases by Industry = Regional Purchases by Industry \* (1-% Excluded Production Value)*

- The total spending by industry was then multiplied by the RIMS II multiplier for each industry, resulting in the total economic impact including direct, indirect, and induced impacts.

*Total Economic Impact = Adjusted Regional Purchases by Industry \* RIMS II Industry Multiplier*

Spending by year was further summarized into two time periods: “start-up,” which includes the two years prior to the project’s operations; and “operations,” which includes ten years operations and two years of closure (twelve years in all).

In terms of output, RIMS II defines earnings as consisting of wages and salaries and of proprietors’ income, which is the net earnings of sole-proprietors and partnerships and includes employer contributions for health insurance. Output is defined as total business sales. Employment includes both full- and part-time jobs.

## Appendix I: Budget Line Items to Industries, with Local Consumption Assumptions

The table below provides more details on the inputs to the economic model. It maps 125 budget items to the specific Maine industries used in the RIMS II economic model. (The costs in the table are aggregated to the category level for reasons of confidentiality.) The table also displays the assumptions about local consumption for equipment and labor costs, by line item. These assumptions were supplied by Wolfden based on their expectations of sourcing materials and labor locally and provide a range of the plausible percentage of equipment and labor that the Project intends to procure locally for each category of spending. The difference between the lower and upper bounds of the range is roughly 20%. The upper value is used in the economic modeling. See Table 28 in the body of this report for estimates of the economic impact based on a low and high estimate of local procurement.

Project Category	Spending	Final RIMS II Industry Used in Economic Model	Description	Detailed Description	Est. % Equipment Spend in Economic Region	Est. % Labor Spend in Economic Region
<b>Capital Expenses, per cash flow model</b>						
<b>Infrastructure</b>	\$20,112,000	Construction	<b>Buildings earthworks</b>	General earthworks for building construction (Foundation prep)	80-100%	80-100%
			<b>Dry facility</b>	Building complex with working clothes area, civilian clothes area and showers for mining and concentrator employees	0%	80-100%
			<b>Effluent pond</b>	Clean water is stored in this pond and tested to confirm quality prior to discharging to the environment via diffusers	80-100%	80-100%
			<b>Main Access Road (Expand logging road)</b>	Expand sections of the access roadway to provide safe passage for delivery and smaller vehicles.	80-100%	80-100%
			<b>Main operations pad prep</b>	Site grading and contouring to support access to various infrastructure	80-100%	80-100%
			<b>Office buildings</b>	Building complex with working clothes area, civilian clothes area and showers for mining and concentrator employees	0%	80-100%
			<b>Ore Pad/Temp Stockpile</b>	Storage pad construction to ensure impacted water is collected. Various pads required for ore, waste rock, and organics storages.	80-100%	80-100%
			<b>Pad construction</b>	Storage pad construction to ensure impacted water is collected. Various pads required for ore, waste rock, and organics storages.	80-100%	80-100%
			<b>Parking</b>	Parking area for employee and visitor vehicles	80-100%	80-100%
			<b>Potable Water System</b>	Water system required for water potability (Toilets, sinks, showers). Not drinking water.	80-100%	80-100%
			<b>Septic System</b>	Septic system for employee and visitor waste	80-100%	80-100%
			<b>Shop Facility</b>	Shop building and bridge crane for servicing and maintaining mobile equipment (Surface)	80-100%	80-100%
			<b>Waste dump Construction (Acid Generating)</b>	Storage pad construction to ensure impacted water is collected. Various pads required for ore, waste rock, and organics storages.	80-100%	80-100%

Project Category	Spending	Final RIMS II Industry Used in Economic Model	Description	Detailed Description	Est. % Equipment Spend in Economic Region	Est. % Labor Spend in Economic Region
			<b>Waste dump Construction (Clean)</b>	Storage pad construction to ensure impacted water is collected. Various pads required for ore, waste rock, and organics storages.	80-100%	80-100%
		Utilities	<b>Emera Power Transition</b>	Electrical power supply with 6MW capacity from Houlton to site	80-100%	80-100%
			<b>Fuel storage</b>	Fuel storage	80-100%	80-100%
			<b>Power distribution</b>	Electrical power transformation and distribution from the 6MW supply to individual infrastructure around the project.	80-100%	80-100%
		Wholesale trade	<b>Propane</b>	Prepare storage facility (General heating fuel)	80-100%	80-100%
<b>Mill</b>	\$34,581,000	Construction	<b>Coating &amp; Sealants (@ 1%)</b>	Coating in flotation cells pump tanks, grinding mills, etc.	80-100%	80-100%
			<b>Concrete (@ 10%)</b>	Foundation work for concentrator components	80-100%	80-100%
			<b>Electrical (@ 12%)</b>	Electrical distribution within the concentrator	80-100%	80-100%
			<b>Installation Labor (@ 70%)</b>	Fitting labor (Generally millwrights, electricians, mechanics, steel fitters, welders, etc..)	0%	56-70%
			<b>Instrumentation (@ 7%)</b>	Instrumentation including reagent dosing, throughput and grade feedback, moisture feedback of the material, human machine interface, remote reporting, etc.	80-100%	56-70%
			<b>Insulation (@ 3%)</b>	Insulation	80-100%	80-100%
			<b>Mill Building</b>	Concentrator building	80-100%	80-100%
			<b>Piping (@ 30%)</b>	Plumbing throughout the concentrator	80-100%	80-100%
			<b>Process Water Treatment</b>	Process water conditioning used to ensure efficient circulation of concentrator discharge water to intake.	0%	40-50%
			<b>Structural Steel (@ 10%)</b>	Steel structures for supporting components, flooring, etc.	80-100%	80-100%
		Wholesale trade	<b>Equipment</b>	Specialized milling equipment (Grinding mills, flotation cells, froth pumps etc.)	0%	0%
<b>Mine Equipment Leasing and Remanufacturing</b>	\$17,252,300	Wholesale trade	<b>Light Service Vehicle / Utility Boom Truck</b>	Light vehicles and service vehicles to support mining operations	80-100%	0%
<b>Mine Facilities and Equipment</b>	\$17,189,000	Construction	<b>Cemented Backfill Plant</b>	Standard concrete mixing station within a building and on a concrete pad.	80-100%	80-100%
			<b>Engineering &amp; Geology Equipment</b>	Survey equipment, ventilation equipment, environmental equipment	80-100%	80-100%
			<b>Explosives &amp; Detonators Magazines Construction &amp; Equipping</b>	Underground explosives magazine (Excavation and room construction)	80-100%	16-20%
			<b>Fueling Station (Marcotte)</b>	Underground fueling station (Excavation and room construction)	0%	16-20%
			<b>Hoisting plant system</b>	Large steel building to support vertical hoisting of rocks from underground	0%	40-50%
			<b>Main Dewatering Sump Construction &amp; Equipping</b>	Underground dewatering sumps (Excavations, construction, and plumbing)	80-100%	16-20%

Project Category	Spending	Final RIMS II Industry Used in Economic Model	Description	Detailed Description	Est. % Equipment Spend in Economic Region	Est. % Labor Spend in Economic Region
			<b>Main Storage Area Construction &amp; Equipping</b>	Underground storage area (Excavation and construction and stocking)	80-100%	16-20%
			<b>Maintenance Breakdown Shop</b>	Shop excavation and bridge crane for servicing and maintaining mobile equipment (Underground)	80-100%	16-20%
			<b>Mine Portal</b>	Excavation and securing the mine entrance (Portal)	0%	0-10%
			<b>Mob, Setup &amp; Demob</b>	All contracts and supplies mobilization to and from site.	20-25%	10-33%
			<b>Portable Toilets</b>	Portapotti type toilets with removable and replaceable storage pods.	80-100%	16-20%
			<b>Refuge Station Construction &amp; Equipping</b>	Underground refuge location (Excavation, construction). Used in case of fire underground for safe retreat of workforce	80-100%	16-20%
		Support activities for mining	<b>Backfill Distribution System</b>	Distribution from the backfill plant to underground	80-100%	16-20%
			<b>Explosives Magazines (Supplier Provided)</b>	Temporary explosives storage typically supplied by the explosives supplier and federally regulated.	80-100%	0%
		Wholesale trade	<b>Compressors</b>	Machines supply compressed air to both mine and concentrator.	80-100%	0%
			<b>Computers, Peripherals &amp; Software</b>	Computer hardware and software	80-100%	80-100%
			<b>Exhaust Ventilation Fans Installations</b>	Main ventilation fans to supply all fresh air into the mine workings	0%	40-50%
			<b>Mine Air Heaters</b>	Main heating system to manage mine temperature during cold months (Typically propane fired)	0%	80-100%
			<b>Mine Communication</b>	Communication link to site, and throughout site and underground	0%	16-20%
			<b>Mine Lamps</b>	Headlamps used by miners to provide lighting underground	0%	0%
			<b>Mine Rescue and Fire Fighting Equipment</b>	BG4/SCBA or similar as well as general firefighting equipment and vehicle	0%	0%
			<b>Portable Substations</b>	Substations used for transforming power voltage (Typically from 4160v to 454v or 600v)	80-100%	16-20%
			<b>Surface Intake Vent Fan Installation</b>	Main ventilation fans to supply all fresh air into the mine workings	0%	80-100%
			<b>Underground Booster Fans &amp; Auxiliary Ventilation</b>	Smaller auxiliary fans to force clean air into dead end drifts and tunnels	0%	40-50%
<b>Owners Indirect</b>	\$6,333,000	Accommodation	<b>Travel</b>	Employee travel for training, conference, etc..	0%	0%
		Construction	<b>Road and Yard Maintenance</b>	General contract maintenance. Snow removal etc.	80-100%	80-100%
		Households	<b>G&amp;A</b>	Admin and technical employment	0%	0%
		Utilities	<b>Power</b>	Power consumption	80-100%	0%
		Wholesale trade	<b>Mine Air Heating</b>	Propane consumption	80-100%	80-100%
<b>Reclamation and Closure</b>	\$5,004,500	Construction	<b>Mine Backfill</b>	Placing final bits of waste rock material back underground into voids	80-100%	80-100%
			<b>Revegetation</b>	Mulching, haying, seeding, planting, and promoting regrowth of vegetation post closure	80-100%	80-100%

Project Category	Spending	Final RIMS II Industry Used in Economic Model	Description	Detailed Description	Est. % Equipment Spend in Economic Region	Est. % Labor Spend in Economic Region
		Waste management and remediation services	<b>Mine Building Removal</b>	Demolition and sale/removal of building and associated materials	80-100%	80-100%
<b>Surface Mobile Equipment</b>	\$1,000,000	Wholesale trade	<b>Front end loader / zoom boom purchase</b>	Loader and forklifts for receiving and moving materials onsite, clearing snow, etc..	80-100%	
<b>Tailings Storage Facility</b>	\$13,672,200	Construction	<b>Earthworks and liners</b>	Construction of a 2-3' thick clay liner, seepage collection system and HDPE liner. (Similar design to landfills)	80-87%	80-87%
<b>Underground Development</b>	\$87,423,500	Households	<b>Manpower Year 3 On</b>	Hired labor, supervision and management		64-80%
		Support activities for mining	<b>Explosives &amp; Accessories</b>	Ammonium Nitrate Fuel Oil. Typical explosives in mining and quarrying.	180-100%	
			<b>Manpower before Year 3</b>	Contract mining and milling while continued workforce training		8-10%
		Wholesale trade	<b>Drilling Bits &amp; Steel</b>	metal drill bits used to bore through dirt and rock	40-50%	0%
			<b>Electrical Power</b>	Electrical cabling and components (Junction boxes etc..)	80-100%	0%
			<b>Equipment Leasing Cost</b>	Leasing costs for major mining equipment. Scoops, trucks, drills, bolters, etc.	0%	0%
			<b>Equipment Operating</b>	Maintenance supplies and replacement parts for operating equipment	80-100%	0%
			<b>Ground Support (Rebar, mesh screen, 3/4 cables)</b>	Fabricated rebar and screen mesh, chain, d rings, etc.	0%	0%
			<b>Services Infrastructure</b>	Piping, hangers, communications, etc.	80-100%	0%
			<b>Ventilation</b>	Ventilation tubing used for carrying clean air to the face for workers.	0%	0%
<b>Operating Expenses, per cash flow model</b>						
<b>Dry Stack Placement of Tailings</b>	\$5,424,800	Construction	<b>Earthworks and liners</b>	placing tailings on the tailing's facility. Truck, loader, and roller compactor	80-87%	80-87%
<b>Environmental and Sustainable Development (\$/t)</b>	\$15,957,400	Construction	<b>Environmental and Sustainable Development (\$/t)</b>	(blank)	0%	80-100%
<b>General and Administration</b>	\$33,230,000	Accommodation	<b>Travel &amp; Accommodations</b>	Travel & Accommodations	0%	0%
		Administrative and support services	<b>Cleaning contract</b>	Cleaning contract	80-100%	80-100%
			<b>Roads and Yards Maintenance</b>	Roads and Yards Maintenance	0%	80-100%
		Construction	<b>Buildings Maintenance</b>	Buildings Maintenance	80-100%	0%
			<b>Office Equipment Leases</b>	Office Equipment Leases	80-100%	0%
			<b>Safety Equipment</b>	Safety Equipment	64-80%	16-20%
		General merchandise stores	<b>Computer Supplies</b>	Computer Supplies	80-100%	0%



Project Category	Spending	Final RIMS II Industry Used in Economic Model	Description	Detailed Description	Est. % Equipment Spend in Economic Region	Est. % Labor Spend in Economic Region
			<b>Office Supplies</b>	Office Supplies	80-100%	0%
		Households	<b>Government Relations</b>	Government Relations	0%	40-50%
			<b>Salaries &amp; Overhead</b>	Salaried employees	0%	32-40%
			<b>Surface ITC</b>	(blank)	0%	80-100%
			<b>Training</b>	In house training (not including miner and mill operator training courses)	0%	0%
		Professional, scientific, and technical services	<b>Communications</b>	Communications	40-50%	40-50%
			<b>Consultants &amp; Vendors</b>	Consultants & Vendors	0%	50%
			<b>Dues &amp; Subscriptions</b>	Dues & Subscriptions	80-100%	80-100%
			<b>Human Resources</b>	Human Resources	0%	80-100%
			<b>Insurance</b>	Insurance	0%	80-100%
			<b>Legal and Accounting</b>	Legal and Accounting	0%	40-50%
			<b>Marketing</b>	Marketing	0%	40-50%
			<b>Public Relations</b>	<b>Public Relations</b>	80-100%	80-100%
		Securities, commodity contracts, and other financial investments and related activities	<b>Bank Costs</b>	Bank Costs	0%	80-100%
		Truck transportation	<b>Light Vehicles Operation</b>	Light Vehicles Operation	80-100%	0%
			<b>Shipping, Courier and light freight</b>	Shipping, Courier, and light freight	0%	80-100%
		Utilities*	<b>Power</b>	Power	80-100%	0%
		Wholesale trade	<b>Electrical Distribution Repair</b>	Electrical Distribution Repair	80-100%	80-100%
			<b>Medical, Health &amp; Safety</b>	(blank)	80-100%	0%
			<b>Security Supplies</b>	Security Supplies	80-100%	0%
			<b>Water Supply &amp; Water Treatment</b>	Water Supply & Water Treatment	40-50%	64-80%
<b>Haulage to Concentrator</b>	\$23,784,700	Construction	<b>(blank)</b>	(blank)	40-50%	80-100%
<b>Surface Services (\$/t)</b>	\$11,000,000	Households	<b>Surface Services (\$/t)</b>	Surface labor incl general construction work, cleaning staff, etc.	0%	80-100%
<b>Processing</b>	\$130,627,900	Construction	<b>Equipment Operation</b>	General pumps and tanks maintenance and operation	40-50%	0%
			<b>Sundry Items</b>	Sundry Items	80-100%	0%

Project Category	Spending	Final RIMS II Industry Used in Economic Model	Description	Detailed Description	Est. % Equipment Spend in Economic Region	Est. % Labor Spend in Economic Region
			<b>Supplies</b>	General pumps and tanks maintenance and operation	0%	0%
			<b>Tailings Dewatering</b>	Tailings thickener and filter press to remove water from tailings	40-50%	64-80%
		Households	<b>Administration</b>	Admin labor	0%	64-80%
			<b>Labor</b>	Labor operating all sections of the concentrator	0%	50-75%
<b>Underground Mining</b>	\$199,531,000	Construction	<b>Backfill</b>	Transporting and placement of backfill material to underground voids	80-100%	80-100%
		Households	<b>Longhole Blasting</b>	Explosives and labor related to loading and blasting ore tonnes	80-100%	80-100%
			<b>Longhole Drilling Manpower</b>	drillers related to drilling and blasting ore tonnes	0%	80-100%
			<b>Services Manpower</b>	manpower for installing pipe and cable and ventilation and coms, etc....	0%	50-75%
		Utilities*	<b>Electrical Power</b>	Electrical supply to underground	80-100%	0%
		Wholesale trade	<b>Cable Bolting</b>	Drilling and installation of long steel cables into the top of underground openings for ground support. Making safe work environments	40-50%	0%
			<b>Haul Truck</b>	Servicing and maintenance of material handlings fleet	20-25%	80-100%
			<b>Heating Costs</b>	Propane consumption	80-100%	0%
			<b>Longhole Drilling Operating Costs</b>	drilling supplies related to drilling and blasting ore tonnes	50%	80-100%
			<b>Services Equipment</b>	Plumbing throughout the mine	80-100%	0%
			<b>Stope Development</b>	Equipment, tooling and supplies used for developing drifts (tunneling)	40-50%	0%
			<b>Stope Mucking</b>	Servicing and maintenance of material handlings fleet	20-25%	80-100%
<b>Total</b>	\$622,123,300					

## Appendix J: Estimate of Direct Costs by LUPC Jurisdiction

	Total	In Region	In LUPC Jurisdiction	% in LUPC (of total)	% in LUPC (of region)
<b>Capex</b>	\$202,567,400	\$91,935,200	\$57,067,900	28%	62%
<b>Underground Development</b>	\$87,423,500	\$33,486,400	\$33,486,400	38%	100%
<b>Mill</b>	\$34,581,000	\$17,546,900	\$0	0%	0%
<b>Infrastructure</b>	\$20,112,000	\$17,255,900	\$14,702,100	73%	85%
<b>Mine Equipment Leasing and Remanufacturing</b>	\$17,252,300	\$154,000	\$154,000	1%	100%
<b>Mine Facilities and Equipment</b>	\$17,189,000	\$5,394,800	\$5,394,800	31%	100%
<b>Tailings Storage Facility</b>	\$13,672,200	\$11,894,800	\$0	0%	0%
<b>Owners Indirect</b>	\$6,333,000	\$970,400	\$414,600	7%	43%
<b>Reclamation and Closure</b>	\$5,004,500	\$5,004,500	\$2,802,200	56%	56%
<b>Surface Mobile Equipment</b>	\$1,000,000	\$227,500	\$113,800	11%	50%
<b>Opex</b>	\$419,555,800	\$247,793,000	\$175,316,600	42%	71%
<b>Underground Mining</b>	\$199,531,000	\$134,405,500	\$134,405,500	67%	100%
<b>Processing</b>	\$130,627,900	\$48,251,900	\$0	0%	0%
<b>General and Administration</b>	\$33,230,000	\$14,590,800	\$7,295,400	22%	50%
<b>Haulage to Concentrator</b>	\$23,784,700	\$21,406,300	\$21,406,300	90%	100%
<b>Environmental and Sustainable Development (\$/t)</b>	\$15,957,400	\$15,957,400	\$7,978,700	50%	50%
<b>Surface Services (\$/t)</b>	\$11,000,000	\$8,461,500	\$4,230,800	38%	50%
<b>Dry Stack Placement of Tailings</b>	\$5,424,800	\$4,719,600	\$0	0%	0%
<b>Grand Total</b>	\$622,123,200	\$339,728,200	\$232,384,500	37%	68%

## Appendix K: Economic Impact by Phase

### *Economic Impact – Start-up (first 2 years)*

		Total Regional Spending	Output	Earnings	Job-Years
	Construction	\$34,583,300	\$55,118,900	\$17,353,900	370
	Wholesale trade	\$1,866,900	\$2,705,900	\$666,100	10
<b>1</b>	<b>Total Investment Expenditures</b>	<b>\$36,450,200</b>	<b>\$57,824,700</b>	<b>\$18,020,000</b>	<b>380</b>
<b>1a</b>	<b>Project Employee Earnings (Households)</b>	<b>\$2,065,200</b>	<b>\$1,537,500</b>	<b>\$467,800</b>	<b>10</b>
	Utilities	\$8,629,700	\$11,796,800	\$2,160,000	30
	Support activities for mining	\$3,703,700	\$5,399,600	\$1,567,000	30
	Professional services	\$0	\$0	\$0	0
	Waste management	\$3,426,100	\$5,143,900	\$1,261,100	30
	Truck transportation	\$0	\$0	\$0	0
	Administrative and support services	\$0	\$0	\$0	0
	General merchandise stores	\$0	\$0	\$0	0
	Financial investments and related	\$0	\$0	\$0	0
<b>2</b>	<b>Total Intermediate Expenditures</b>	<b>\$17,824,600</b>	<b>\$23,877,800</b>	<b>\$5,455,900</b>	<b>100</b>
<b>3</b>	<b>Regional Impact (1+2)</b>	<b>\$54,274,800</b>	<b>\$81,702,500</b>	<b>\$23,475,900</b>	<b>490</b>
<b>4</b>	<b>Non-Regional Spending – Investment Expenditures</b>	<b>\$35,649,500</b>			
<b>5</b>	<b>Non-Regional Spending - Intermediate Expenditures</b>	<b>\$19,496,800</b>			
<b>6</b>	<b>Total Project Spending (3+4+5)</b>	<b>\$109,421,100</b>			
<b>7</b>	<b>Initial Spending on Intermediate Expenditures (2+5)</b>		<b>\$37,321,400</b>		
<b>8</b>	<b>Initial Wages to Project Employees (1a)</b>			<b>\$2,065,200</b>	
<b>9</b>	<b>Initial Project Job-Years (projections)</b>				<b>30</b>
			Output	Earnings	Job-years
<b>10</b>	<b>Total Impact (3+7+8+9)</b>		<b>\$119,024,000</b>	<b>\$25,541,100</b>	<b>510</b>
<b>11</b>	<b>Implied Multiplier</b>		<b>1.1</b>	<b>0.2</b>	<b>4.6</b>

**Economic Impact – Operations (12 years)**

		Total Regional Spending	Output	Earnings	Job-Years
	Construction	\$130,147,300	\$207,428,800	\$65,307,900	1,390
	Wholesale trade	\$7,677,700	\$11,128,100	\$2,739,400	50
<b>1</b>	<b>Total Investment Expenditures</b>	<b>\$137,825,100</b>	<b>\$218,557,000</b>	<b>\$68,047,400</b>	<b>1,440</b>
<b>1a</b>	Project Employee Earnings (Households)	\$116,826,200	\$86,977,100	\$26,461,100	710
	Utilities	\$16,956,400	\$23,179,400	\$4,244,200	60
	Support activities for mining	\$7,895,700	\$11,511,200	\$3,340,700	70
	Professional services	\$4,450,000	\$6,723,500	\$2,603,700	50
	Waste management	\$0	\$0	\$0	0
	Truck transportation	\$550,000	\$898,200	\$269,600	10
	Administrative and support services	\$500,000	\$783,100	\$299,600	10
	General merchandise stores	\$350,000	\$515,700	\$156,000	10
	Financial investments and related	\$100,000	\$156,000	\$56,100	0
<b>2</b>	<b>Total Intermediate Expenditures</b>	<b>\$147,628,400</b>	<b>\$130,744,300</b>	<b>\$37,431,000</b>	<b>920</b>
<b>3</b>	<b>Regional Impact (1+2)</b>	<b>\$285,453,400</b>	<b>\$349,301,100</b>	<b>\$105,478,300</b>	<b>2,360</b>
<b>4</b>	Non-Regional Spending – Investment Expenditures	\$128,679,000			
<b>5</b>	Non-Regional Spending - Intermediate Expenditures	\$98,569,800			
<b>6</b>	<b>Total Project Spending (3+4+5)</b>	<b>\$512,702,200</b>			
<b>7</b>	Initial Spending on Intermediate Expenditures (2+5)		\$246,198,200		
<b>8</b>	Initial Wages to Project Employees (1a)			\$116,826,200	
<b>9</b>	Initial Project Job-Years (projections)				1,670
			Output	Earnings	Job-years
<b>10</b>	<b>Total Impact (3+7+8+9)</b>		<b>\$595,499,300</b>	<b>\$222,304,500</b>	<b>4,030</b>
<b>11</b>	Implied Multiplier		1.2	0.4	7.9



**Total Economic Impact, All Years**

		<b>Total Regional Spending</b>	<b>Output</b>	<b>Earnings</b>	<b>Job-Years</b>
	Construction	\$164,730,700	\$262,547,700	\$82,661,800	1,760
	Wholesale trade	\$9,544,600	\$13,834,000	\$3,405,500	60
<b>1</b>	<b>Total Investment Expenditures</b>	<b>\$174,275,300</b>	<b>\$276,381,700</b>	<b>\$86,067,400</b>	<b>1,820</b>
<b>1a</b>	Project Employee Earnings (Households)	\$118,891,400	\$88,514,600	\$26,928,900	730
	Utilities	\$25,586,100	\$34,976,200	\$6,404,200	100
	Support activities for mining	\$11,599,400	\$16,910,800	\$4,907,700	100
	Professional services	\$4,450,000	\$6,723,500	\$2,603,700	50
	Waste management	\$3,426,100	\$5,143,900	\$1,261,100	30
	Truck transportation	\$550,000	\$898,200	\$269,600	10
	Administrative and support services	\$500,000	\$783,100	\$299,600	10
	General merchandise stores	\$350,000	\$515,700	\$156,000	10
	Financial investments and related	\$100,000	\$156,000	\$56,100	0
<b>2</b>	<b>Total Intermediate Expenditures</b>	<b>\$165,453,000</b>	<b>\$154,622,100</b>	<b>\$42,886,900</b>	<b>1,020</b>
<b>3</b>	<b>Regional Impact (1+2)</b>	<b>\$339,728,300</b>	<b>\$431,003,800</b>	<b>\$128,954,300</b>	<b>2,840</b>
<b>4</b>	Non-Regional Spending – Investment Expenditures	\$164,329,600			
<b>5</b>	Non-Regional Spending - Intermediate Expenditures	\$118,065,300			
<b>6</b>	<b>Total Project Spending (3+4+5)</b>	<b>\$622,123,200</b>			
<b>7</b>	Initial Spending on Intermediate Expenditures (2+5)		\$283,518,400		
<b>8</b>	Initial Wages to Project Employees (1a)			\$118,891,400	
<b>9</b>	Initial Project Job-Years (projections)				1,700
			<i>Output</i>	<i>Earnings</i>	<i>Job-years</i>
<b>10</b>	<b>Total Impact (3+7+8+9)</b>		\$714,522,200	\$247,845,700	4,540
<b>11</b>	Implied Multiplier		1.1	0.4	7.3

## Appendix L: Job-years by Project Phase

	<b>Start-up</b>	<b>Operations</b>	<b>Total</b>
<b>Agriculture, forestry, fishing and hunting</b>	0	20	20
<b>Mining, quarrying, and oil and gas extraction</b>	290	1,470	1,760
<b>Utilities*</b>	10	30	40
<b>Construction</b>	220	840	1,070
<b>Durable goods manufacturing</b>	10	50	60
<b>Nondurable goods manufacturing</b>	0	20	20
<b>Wholesale trade</b>	10	70	80
<b>Retail trade</b>	50	320	370
<b>Transportation and warehousing*</b>	10	60	70
<b>Information</b>	0	20	30
<b>Finance and insurance</b>	0	30	40
<b>Real estate and rental and leasing</b>	20	160	180
<b>Professional, scientific, and technical services</b>	10	80	90
<b>Management of companies and enterprises</b>	0	10	20
<b>Administrative and support and waste management and remediation services</b>	30	60	90
<b>Educational services</b>	10	50	60
<b>Health care and social assistance</b>	30	260	280
<b>Arts, entertainment, and recreation</b>	0	20	20
<b>Accommodation</b>	0	20	20
<b>Food services and drinking places</b>	10	110	130
<b>Other services*</b>	10	80	90
<b>Total</b>	<b>720</b>	<b>3,780</b>	<b>4,540</b>

## Appendix M: Comparison of cash-flow summary to economic input estimates

The table below reconciles the Project's expenses reported in the updated Preliminary Economic Assessment (PEA) petition (Exhibit 10) with the expenses used as inputs to the economic model in this report. Expenses related to working capital, contingency spending, and reclamation were excluded from the economic model because they have not yet been committed to specific purposes. The Bureau of Economic Analysis Regional Input-Output Modeling System (RIMS II) provides multipliers for 406 industries.

	Start-up	Operations	Total
<b>OPERATING COSTS – WOLF DEN CASH FLOW</b>			
Underground Mining	\$196,437,800	\$199,531,000	\$196,437,800
Processing	\$128,602,900	\$130,627,900	\$128,602,900
Dry Stack Placement of Tailings	\$5,340,700	\$5,424,800	\$5,340,700
Surface Services	\$10,000,000	\$11,000,000	\$10,000,000
General and Administration	\$23,416,000	\$23,784,700	\$23,416,000
Environmental and Sustainable Development	\$33,230,000	\$33,230,000	\$33,230,000
<b>TOTAL OPERATING COSTS</b>	<b>\$6,811,000</b>	<b>\$412,744,800</b>	<b>\$419,555,800</b>
<b>CAPITAL EXPENDITURES – WOLF DEN CASH FLOW</b>			
Underground Development	\$21,435,700	\$65,987,800	\$87,423,500
Mine Facilities and Equipment	\$10,167,500	\$7,021,500	\$17,189,000
Mine Equipment Leasing and Remanufacturing	\$1,974,900	\$15,277,500	\$17,252,300
Infrastructure	\$20,112,000	\$0	\$20,112,000
Surface Mobile Equipment	\$1,000,000	\$0	\$1,000,000
Tailings Storage Facility	\$2,001,500	\$11,670,700	\$13,672,200
Build and equip mill	\$34,581,000	\$0	\$34,581,000
Owners Indirects	\$6,333,000	\$0	\$6,333,000
Financial Assurance Trust-Reclamation and Closure	\$13,684,600	\$0	\$13,684,600
Working Capital	\$12,417,000	-\$12,417,000	\$0

	Start-up	Operations	Total
Contingency @ 20%	\$24,741,400	\$0	\$24,741,400
<b>TOTAL CAPITAL EXPENDITURES</b>	<b>\$148,448,500</b>	<b>\$87,540,400</b>	<b>\$235,988,900</b>
<b>TOTAL ALL EXPENSES</b>	<b>\$155,259,600</b>	<b>\$500,285,200</b>	<b>\$655,544,700</b>
<b>EXCLUDED FROM ECONOMIC MODEL (subtract from above)</b>			
Working Capital	\$12,417,000	-\$12,417,000	\$0
Contingency @ 20% (summarized separately)	\$24,741,400	\$0	\$24,741,400
Reclamation not committed	\$8,680,100	\$0	\$8,680,100
<b>TOTAL EXPENSES EXCLUDED FROM MODEL</b>	<b>\$45,838,500</b>	<b>-\$12,417,000</b>	<b>\$33,421,500</b>
<b>TOTAL EXPENSES, ECONOMIC MODEL</b>	<b>\$109,421,100</b>	<b>\$512,702,200</b>	<b>\$622,123,200</b>

# Appendix N: Map of Maine Tourism Regions

From Maine Department of Transportation at [exploremaine.org](http://exploremaine.org)

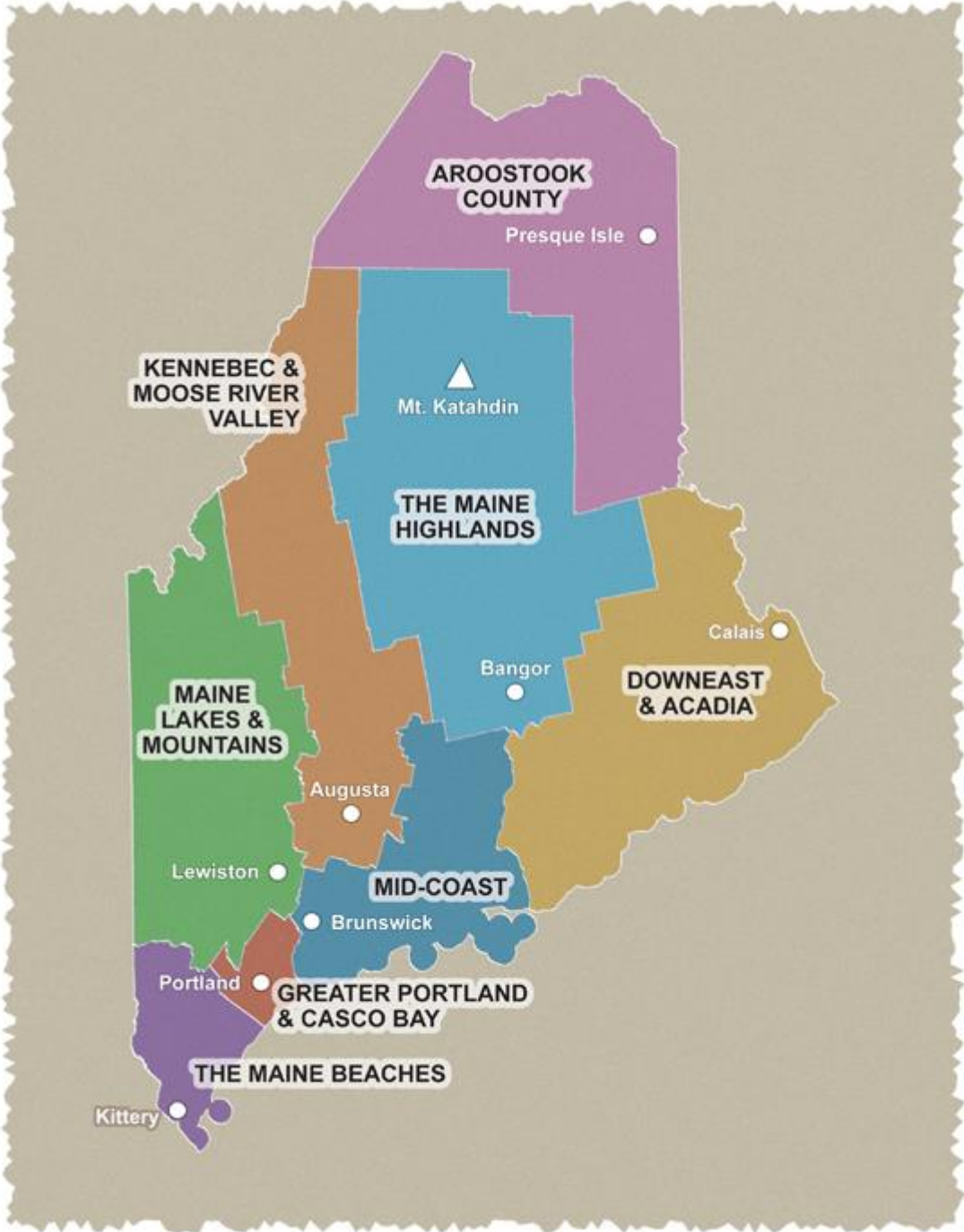



# Appendix O: Map of Businesses Along Transportation Routes

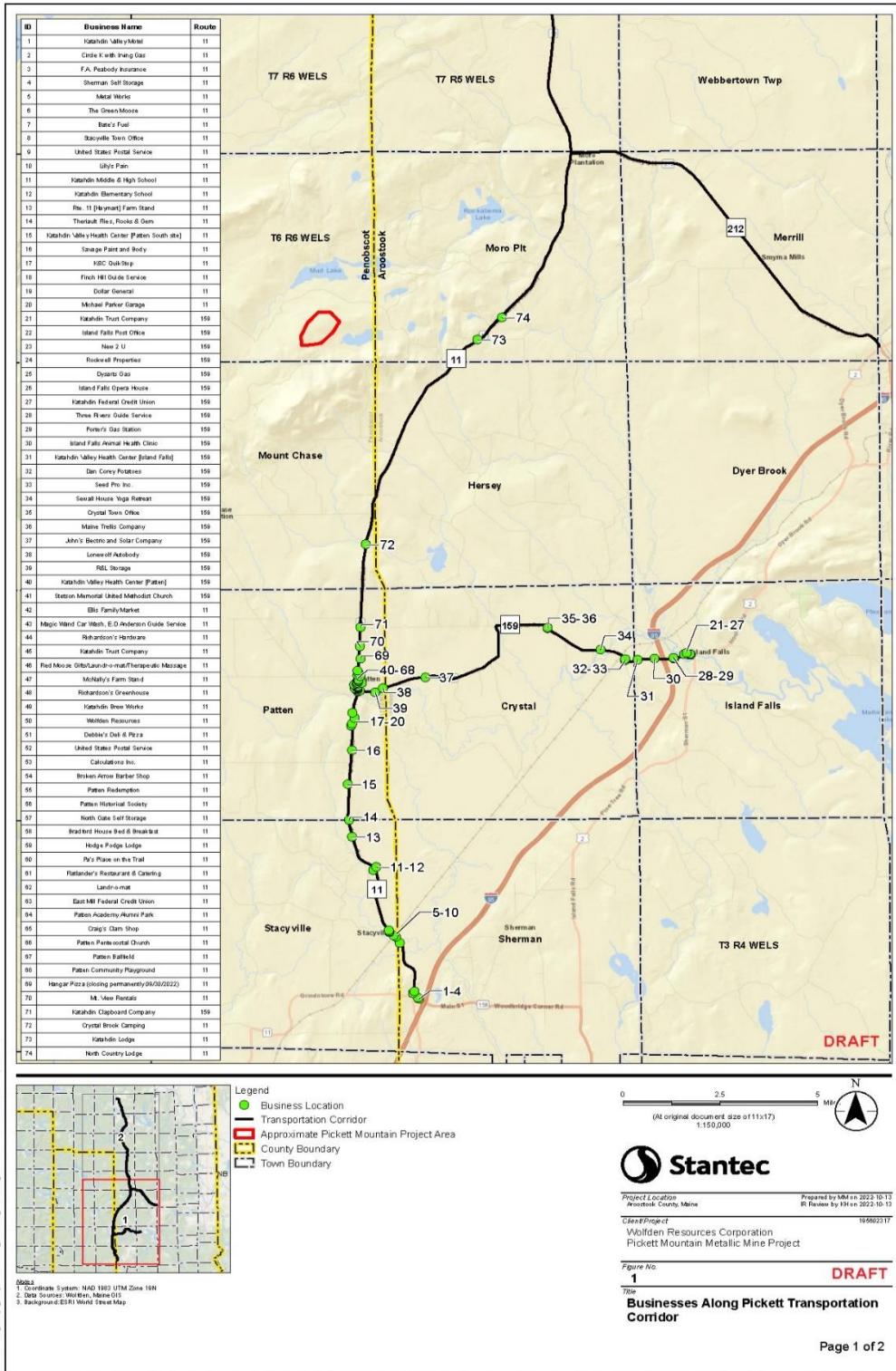



## ENDNOTES

- 
- <sup>1</sup> Two economic development districts are nearby: Northern Maine Development Commission serves all of Aroostook and Washington counties and several towns in Penobscot County, including Houlton and Patten; Eastern Maine Development Commission serves towns in Penobscot, Piscataquis, Hancock, and Waldo counties, including Millinocket.
- <sup>2</sup> U.S. Census Bureau, Geography Division, TIGER/Geographic Identification Code Scheme.
- <sup>3</sup> The median age is the age at which half an area's residents are older and half are younger. For the HLMA and MLMA, median age is estimated as the population-weighted average of the median age of the towns in the region.
- <sup>4</sup> Houlton Band of Maliseet Indians, <http://maliseets.net>, accessed June 16, 2022.
- <sup>5</sup> The U.S. Census Bureau defines a household as all people who occupy the same housing unit, regardless of their relationship; the members of a family occupy the same housing unit and are related by marriage, birth, or adoption.
- <sup>6</sup> Amy K. Glasmeier, Living Wage Calculator, Massachusetts Institute of Technology, 2020. The weekly living wage assumes full-time work and is calculated by multiplying the hourly living wage by 40. Average weekly wages calculated by the Maine Department of Labor do not control for number of hours worked.
- <sup>7</sup> These combined areas align closely with the combined Houlton and Millinocket LMAs. See Appendix F for additional detail.
- <sup>8</sup> Maine Department of Administrative and Financial Services, Maine Revenue Service, Sales Tax Reports, accessed June 12, 2022.
- <sup>9</sup> The Houlton Economic Summary Area (ESA) as defined by Maine Revenue Services, includes the towns of Amity, Bancroft, Danforth, Eaton, Forest City, Glenwood, Hammond Plantation, Haynesville, Hodgdon, Houlton, Linneus, Littleton, Ludlow, Macwachoc Plantation, Molunkus Township, Monticello, New Limerick, Orient, Reed Plantation, Selden, Weston, and Wytopotlock.
- <sup>10</sup> The Millinocket Economic Summary Area (ESA) as defined by Maine Revenue Services, includes the towns of East Millinocket, Grindstone, Medway, Millinocket, West Seboeis, and Woodville.
- <sup>11</sup> The Patten Economic Summary Area (ESA) as defined by Maine Revenue Services, includes the towns of Benedicta, Crystal, Dyer Brook, Hersey, Island Falls, Merrill, Monarda, Moro Plantation, Oakfield, Patten, Sherman, Shin Pond, Silver Ridge Township, Smyrna, Smyrna Mills, and Stacyville.
- <sup>12</sup> Maine Department of Economic and Community Development, Maine Office of Tourism, "Maine Highlands 2021 Economic Impact and Visitor Tracking Report," 2022.
- <sup>13</sup> Maine Department of Economic and Community Development, Maine Office of Tourism, "Maine Highlands 2021 Economic Impact and Visitor Tracking Report," 2022. Accessed at <https://motpartners.com/wp-content/uploads/2022/04/Maine-Highlands-2021-Economic-Impact-and-Visitor-Tracking-Report-FINAL.pdf>.
- <sup>14</sup> Maine Department of Administrative and Financial Services, Maine Revenue Service, Sales Tax Reports, accessed June 12, 2022.
- <sup>15</sup> The Houlton Economic Summary Area (ESA) as defined by Maine Revenue Services, includes the towns of Amity, Bancroft, Cary Plantation, Danforth, Eaton, Forest City, Glenwood, Hammond Plantation, Haynesville, Hodgdon, Houlton, Linneus, Littleton, Ludlow, Macwachoc Plantation, Molunkus Township, Monticello, New Limerick, Orient, Reed Plantation, Selden, Weston, and Wytopotlock.
- <sup>16</sup> The Millinocket Economic Summary Area (ESA) as defined by Maine Revenue Services, includes the towns of East Millinocket, Grindstone, Medway, Millinocket, West Seboeis, and Woodville.
- <sup>17</sup> The Patten Economic Summary Area (ESA) as defined by Maine Revenue Services, includes the towns of Benedicta, Crystal, Dyer Brook, Hersey, Island Falls, Merrill, Monarda, Moro Plantation, Oakfield, Patten, Sherman, Shin Pond, Silver Ridge Township, Smyrna, Smyrna Mills, and Stacyville.
- <sup>18</sup> Ian Hathaway, Jessica Leahy, and Mindy Crandall, The Economic Contribution of Snowmobiling. Forest Resources Student Scholarship (2). 2020. Available at: [https://digitalcommons.library.umaine.edu/sfr\\_studentpub/2](https://digitalcommons.library.umaine.edu/sfr_studentpub/2)
- <sup>19</sup> A series of documents are available from the Governor's Task Force on All-Terrain Vehicle Trail Initiatives. Available at: [https://www.maine.gov/ifw/atv-snowmobile/atv/governors\\_task\\_force.html](https://www.maine.gov/ifw/atv-snowmobile/atv/governors_task_force.html)

- 
- <sup>20</sup> Jonathon Rubin and Charles Morris, Economic Contributions of ATV-Related Activity in Maine. Articles (1). 2005.
- <sup>21</sup> Town of Millinocket, 2021.
- <sup>22</sup> Maine Department of Agriculture, Conservation, and Forestry, available here:  
[https://www.maine.gov/dacf/municipalplanning/docs/2012\\_service\\_centers\\_large.pdf](https://www.maine.gov/dacf/municipalplanning/docs/2012_service_centers_large.pdf)
- <sup>23</sup> Land Use Planning Commission,  
[https://www.maine.gov/dacf/lupc/projects/location\\_of\\_development/AdjacencyConcepts\\_April2019\\_Adopted.pdf](https://www.maine.gov/dacf/lupc/projects/location_of_development/AdjacencyConcepts_April2019_Adopted.pdf)
- <sup>24</sup> U.S. Bureau of Economic Analysis, Regional Input Output Model System Users Guide, page 3-3; see  
<https://www.bea.gov/resources/methodologies/RIMSII-user-guide>
- <sup>25</sup> The RIMS II methodology does not match the definition that A-Z Mining Professionals Inc. uses in listing capital expenses and operating expenses. To be consistent with the RIMS II methodology, each budget line was classified as construction and investment or operations.
- <sup>26</sup> Maine Department of Economic and Community Development, Maine Office of Tourism, “Regional Insights 2019: Maine Highlands,” 2020.
- <sup>27</sup> Ian Hathaway, Jessica Leahy, and Mindy Crandall, The Economic Contribution of Snowmobiling. Forest Resources Student Scholarship (2). 2020. Available at:  
[https://digitalcommons.library.umaine.edu/sfr\\_studentpub/2](https://digitalcommons.library.umaine.edu/sfr_studentpub/2)
- <sup>28</sup> Jonathon Rubin and Charles Morris, Economic Contributions of ATV-Related Activity in Maine. Articles (1). 2005.
- <sup>29</sup> U.S. Census Bureau, Decennial Censuses, 1970-2020, and American Community Survey (ACS), 2016-2020. Note that in 2019, Cary Plantation in Aroostook County reported a population of 291. By the 2020 Census, Cary Plantation had disorganized as a town. While Cary Plantation's population is still included in the Maine and Aroostook County numbers, for the purposes of year-over-year comparison, the population of 291 is adjusted into the Houlton LMA population total for 2020.
- <sup>30</sup> U.S. Census Bureau, Geography Division, TIGER/Geographic Identification Code Scheme.
- <sup>31</sup> U.S. Census Bureau, American Community Survey (ACS), 2016-2020 five-year average.
- <sup>32</sup> U.S. Census Bureau, Decennial Census, 2020.
- <sup>33</sup> U.S. Census Bureau, American Community Survey (ACS), 2016-2020 five-year average.
- <sup>34</sup> Ibid.
- <sup>35</sup> Ibid.
- <sup>36</sup> Ibid.
- <sup>37</sup> U.S. Census Bureau, ACS, 2006-2010 five-year average.
- <sup>38</sup> Maine Department of Labor, Local Area Unemployment Statistics, 2021.
- <sup>39</sup> Ibid.
- <sup>40</sup> Ibid.
- <sup>41</sup> Ibid.
- <sup>42</sup> U.S. Census Bureau, American Community Survey (ACS), 2016-2020 five-year estimate.
- <sup>43</sup> U.S. Census Bureau, ACS, 2011-2015 five-year estimate. This is the earliest year for which the ACS reports this statistic.
- <sup>44</sup> U.S. Census Bureau, American Community Survey (ACS), 2016-2020 five-year estimate.
- <sup>45</sup> Maine Department of Labor, Local Area Unemployment Statistics, 2021.
- <sup>46</sup> Ibid.
- <sup>47</sup> U.S. Census Bureau, American Community Survey (ACS), 2016-2020 five-year estimate.
- <sup>48</sup> Ibid.
- <sup>49</sup> Ibid.
- <sup>50</sup> Ibid.
- <sup>51</sup> North American Industry Classification System
- <sup>52</sup> U.S. Bureau of Labor Statistics, Quarterly Census of Employment and Wages (QCEW), 2021.
- <sup>53</sup> Ibid.
- <sup>54</sup> 2001 is the earliest year for which LMA-level occupation QCEW is available from the Maine Department of Labor.
- <sup>55</sup> U.S. Bureau of Labor Statistics, Quarterly Census of Employment and Wages (QCEW), 2021.

- 
- <sup>56</sup> Amy K. Glasmeier, Living Wage Calculator, Massachusetts Institute of Technology, 2020. The weekly living wage assumes full-time work and is calculated by multiplying the hourly living wage by 40.
- <sup>57</sup> Maine Department of Labor, Center for Workforce Research and Information, “Top 25 Private Employers in Maine by Average Monthly Employment by County (2021 Annual)”, accessed June 12, 2022.
- <sup>58</sup> The Houlton Economic Summary Area (ESA) as defined by Maine Revenue Services, includes the towns of Amity, Bancroft, Cary Plantation, Danforth, Eaton, Forest City, Glenwood, Hammond Plantation, Haynesville, Hodgdon, Houlton, Linneus, Littleton, Ludlow, Macwachoc Plantation, Molunkus Township, Monticello, New Limerick, Orient, Reed Plantation, Selden, Weston, and Wytovitlock.
- <sup>59</sup> The Millinocket Economic Summary Area (ESA) as defined by Maine Revenue Services, includes the towns of East Millinocket, Grindstone, Medway, Millinocket, West Seboeis, and Woodville.
- <sup>60</sup> The Patten Economic Summary Area (ESA) as defined by Maine Revenue Services, includes the towns of Benedicta, Crystal, Dyer Brook, Hersey, Island Falls, Merrill, Monarda, Moro Plantation, Oakfield, Patten, Sherman, Shin Pond, Silver Ridge Township, Smyrna, Smyrna Mills, and Stacyville.
- <sup>61</sup> Maine Department of Administrative and Financial Services, Maine Revenue Service, Sales Tax Reports, accessed June 12, 2022.
- <sup>62</sup> Maine Office of Tourism designated region, encompasses Penobscot and Piscataquis counties.
- <sup>63</sup> Maine Department of Economic and Community Development, Maine Office of Tourism, “2019 Annual Report,” “Regional Insights 2019: Maine Highlands,” “2019 Maine Office of Tourism Highlights,” 2020.
- <sup>64</sup> U.S. Census Bureau, American Community Survey, 2016-2020 five-year average.
- <sup>65</sup> Ibid.
- <sup>66</sup> MaineHousing, 2021 Homeownership Housing Facts and Affordability Index for Maine, <https://www.mainehousing.org/policy-research/housing-data/housing-affordability-indexes>, accessed June 13, 2022.
- <sup>67</sup> MaineHousing, 2020 Rental Housing Facts and Affordability Index for Maine, <https://www.mainehousing.org/policy-research/housing-data/housing-affordability-indexes>, accessed June 13, 2022.
- <sup>68</sup> 2017 is the most recent year for which MaineHousing has data for Houlton LMA. For 2017, MaineHousing used average 2-bedroom rent, rather than median.
- <sup>69</sup> U.S. Census Bureau, American Community Survey, 2016-2020 five-year average.
- <sup>70</sup> University of Wisconsin Population Health Institute, 2022 County Health Rankings, data for 2019 (smoking) and 2019 (obesity). Municipal data not published.
- <sup>71</sup> Maine DHHS, Maine CDC, *The Maine 2020 Annual Report of Cancer*, March 28, 2021, 2013-2017 data for brain and other nervous system tumors, 2015-2017 for all others, municipal data not published.
- <sup>72</sup> Maine DHHS, Maine CDC, *Maine Annual Report of Cancer 2013*, September 2013, 2006-2010 data for brain and other nervous system tumors, 2008-2010 for all others, county-level urinary bladder cancer data not published, municipal data not published.
- <sup>73</sup> Maine Department of Health and Human Services (DHHS), Maine Center of Disease Control (CDC) and Prevention, Maine Diabetes Prevention and Control Program.
- <sup>74</sup> Ibid.
- <sup>75</sup> Ibid.
- <sup>76</sup> U.S. Bureau of Economic Analysis, Input-Output Commodity Composition of Intermediate Purchases by Mining (except oil and gas); Table F - Composition of Intermediate Inputs.



STATE OF MAINE  
DEPARTMENT OF AGRICULTURE, CONSERVATION & FORESTRY  
LAND USE PLANNING COMMISSION

IN THE MATTER OF	)	Pre-Filed Direct Testimony of Terry
REZONING PETITION ZP 779A	)	Thurston-Hill on Behalf of Wolfden Mt.
WOLFDEN MT. CHASE, LLC	)	Chase, LLC

On behalf of Wolfden Mt. Chase, LLC (“Wolfden”), Terry Thurston-Hill is submitting this pre-filed direct testimony in support of ZP 779A.

**I. QUALIFICATIONS AND EXPERIENCE**

I am the co-owner of Shin Pond Village<sup>1</sup> in Mount Chase, Maine, a 100-acre family-operated recreational facility located 15 miles North of the entrance of Baxter State Park. My husband and I have run Shin Pond Village together for 38 years and built the business from the ground up. It now includes campsites, cottages, multiple homes, a general store, restaurant, bar, gift shop, and laundromat. Shin Pond Village is a premier Maine destination for side by side, snowmobile and ATV rentals. In 2018 we became a Polaris Outdoor Adventure Outfitter, offering new Polaris side by sides, ATVs and snowmobile rentals, which now make up a significant portion of our business.

Over the past 38 years I have developed expertise in outdoor recreation in the Mount Chase area as a result of both running a recreational business and my involvement in community-facing recreational organizations. I am deeply invested in the economic stability and growth of the region. More than 20 years ago I joined together with local businesses and community members in Shin Pond, Stacyville, Sherman, and Patten to combat the economic impact of mill closures in Sherman and Patten. This economic development group is still active. Since that time, I have become an active member in the community-based sustainable rural

---

<sup>1</sup> <https://shinpond.com/>



development organization, Katahdin Tourism Partnership.<sup>2</sup> In that organization I assisted in creating and forming an 89-mile scenic byway running from Millinocket to Matagamon.<sup>3</sup> I oversaw many projects on the byway and worked extensively with other groups, including the Maine Department of Transportation, to improve the byway experience and enhance business growth and development in the region. I have also been involved in the Katahdin Chamber of Commerce<sup>4</sup> and the Greater Houlton Chamber of Commerce<sup>5</sup> with a focus on outdoor recreational opportunities, which is where my expertise lies. Shortly following designation of the Katahdin Woods and Waters National Monument, I joined the Board of Directors for Friends of Katahdin Woods and Waters.<sup>6</sup> I have been an active Board member for the past 5-6 years and joined the Board because I felt the Monument was in the best interest of the community and presented a much-needed economic opportunity for the region. I also served on the Board of Directors for the Patten Lumberman's Museum for approximately five years.

For the last 35 years I have been a member of the Bowlin Matagamon Shin Pond Snowmobile Club,<sup>7</sup> which grooms 130 miles of trails and partners with clubs in other nearby areas. Approximately 7 years ago I formed the Shin Pond Trail Riders ATV Club,<sup>8</sup> to manage an additional 70 miles of ATV trails. I have taken active leadership roles in both clubs, including grant writing and ensuring ongoing funding for the organizations. I have seen firsthand the economic benefits that the snowmobile and ATV recreational industries have had on the regional economy. I am also on the Board of Directors for Regional School Unit 89 and have taken an

---

<sup>2</sup> <https://katahdinpartnership.org/>

<sup>3</sup> <https://www.katahdinwoodsandwaters.com/>

<sup>4</sup> <https://www.katahdinmaine.com/>

<sup>5</sup> <https://www.greaterhoulton.com/>

<sup>6</sup> <https://www.friendsofkww.org/>

<sup>7</sup> <https://bowlinmatagamonshinpond.wordpress.com/>

<sup>8</sup> <https://www.atvmaine.org/clubs/shin-pond-trail-riders/>

active role in ensuring that local schools remain open for our students and that outdoor recreation is an integral component of our educational system.

## **II. INVOLVEMENT WITH THE PICKETT MOUNTAIN PROJECT**

In 2019 Wolfden reached out to businesses in the region, including Shin Pond Village, to introduce themselves and the Pickett Mountain Project. Jeremy Ouellette wanted to make sure that he understood the needs of the community and how the Project could partner to bring greater economic opportunities to the region. He also wanted to make sure he understood concerns that people might have about the Project. He has had an open-door policy, has always been transparent, and is always available to meet with members of the community and answer questions. After careful consideration I determined that the Project would bring much-needed economic and employment opportunities to an area with too few well-paying jobs and that the Project was therefore in the best interest of my community. Since that time, I have continued to stay in touch with Wolfden and joined their Community Advisory Committee and have openly showed my support for the Project rezoning through my discussions around the communities.

## **III. REGIONAL OUTDOOR RECREATION**

Historically this region was built on the hunting and fishing industries. However, the snowmobile and ATV industries are currently the two economic drivers in the regional outdoor recreation economy due to the decline in hunting and fishing. The snowmobile and ATV industries have significantly expanded in the last ten years and there has been sufficient demand to support the growth and development of new recreational businesses in the region that focus on ATVs and snowmobiles. These two industries are the driving force of my business, and I depend on them for my livelihood. Due to the dominance of the snowmobile and ATV recreational industries in the regional economy, it is critical that the hundreds of miles of surrounding trails are well-maintained and accessible for recreational users.

#### **IV. COMPATABILITY AND BENEFITS OF THE PROJECT**

Based on my experience in the regional outdoor recreation economy, the Pickett Mountain Project is compatible with that economy and will not negatively impact outdoor recreation in the region. The Project has a small footprint, and the proposed rezoned area is only a very small portion of the much larger recreational region. Many of the ATV and snowmobile trails that are groomed and maintained in the region go around the project and will be unaffected. To the extent a trail needs to be moved, local recreational clubs will work with Wolfden to establish a suitable trail elsewhere. There are existing trails on Wolfden's property outside the rezone area, and Wolfden has indicated that except for the small rezone area, its property will remain open for recreational use which has been the case with club agreements. We appreciate that commitment because our trail system relies on the generosity of landowners to allow the public to use their property.

I do not believe that snowmobilers or ATV users will be adversely impacted in any way by the Project. I also do not believe that other types of outdoor recreation activities such as hiking, fishing, and hunting, will be adversely impacted. The rezone area is a small portion of the larger region where those activities occur and is not proximate to Baxter State Park or the National Monument, which are important destinations in the State, nor is the project along the access routes or within viewshed from either of those destinations. It is key, of course, that the Project meet stringent standards related to protecting water quality and our streams and ponds. I am confident that the DEP process will ensure that is the case.

In addition to the Project being compatible with the outdoor recreation economy in the region, the Project offers necessary job opportunities for people living in the region. Since the closure of the mills, I have seen my community and the broader region struggle economically. There are too few jobs that pay a livable wage. As a business owner and community member

involved in a wide variety of community initiatives, I know many young people who have been forced to find employment outside of the region and work away 9 months of the year because they are unable to find regional employment that enable them to earn a living wage.

The Project will bring create jobs and bring new economic opportunities to a region that has been struggling since the closure of the mills. It will allow young workers who are forced to find employment in other areas of the state, to earn a livable wage closer to home. This will in turn spur growth in other industries in the region and help to revitalize an area that is in significant need to new development and economic opportunities. The Project will also offer opportunities for young people to develop new skills and trades that are transferable and usable even after the mine has closed.

I, like many others at the time, did not initially support the Katahdin Woods and Waters Monument. There was fear of the unknown and discomfort with the federal government's involvement in our region. After researching the project, listening to others, and carefully considering the information before me, I came to believe that it would be beneficial to my community and now support it. I have done the same here and have reached a similar conclusion. The Project will not only have no negative impact the outdoor recreation economy, but will create new economic opportunities for our businesses, communities, and young people who live here.

Dated: 9/19/2023

Terry Thurston-Hill

Terry Thurston-Hill

State of Maine, Penobscot County

Date: 9-19-23

Personally appeared before me the above named Terry Thurston-Hill, who, being duly sworn, did testify that the foregoing testimony was true and correct to the best of his knowledge and belief.

Before me,

[Signature]

Notary Public

My commission expires: August 4, 2029